

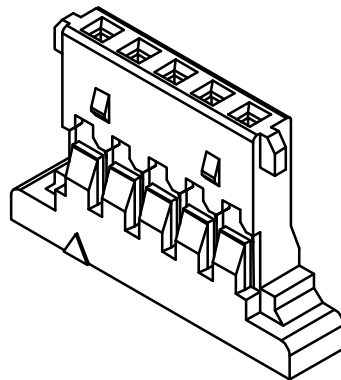

51146 Type Housing

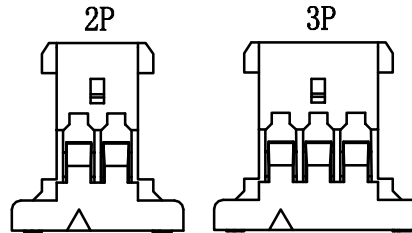

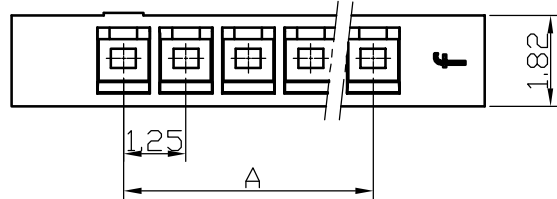
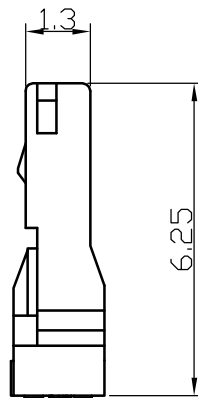
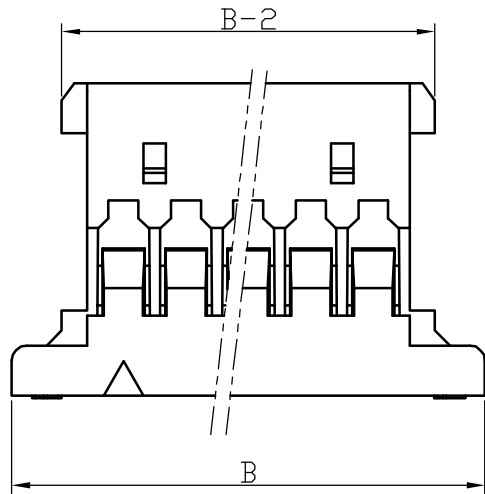

Poles	Part No.		Dimensions	
			A	B
2	WB1253-H02	51146-2Y	1.25	5.72
3	WB1253-H03	51146-3Y	2.5	6.97
4	WB1253-H04	51146-4Y	3.75	8.22
5	WB1253-H05	51146-5Y	5	9.47
6	WB1253-H06	51146-6Y	6.25	10.72
7	WB1253-H07	51146-7Y	7.5	11.97
8	WB1253-H08	51146-8Y	8.75	13.22
9	WB1253-H09	51146-9Y	10	14.47
10	WB1253-H10	51146-10Y	11.25	15.72
11	WB1253-H11	51146-11Y	12.5	16.97
-	-	-	-	-
30	WB1253-H30	51146-30Y	36.25	40.72

1	Housing	PA66 (UL94V-0/V-2)	1						
No.	Item/Material No.	Material	QTY	Remark					
Unmarked Tolerance		 Yueqing Hegxing Electronics Co., Ltd							
X. ° ±3°	X. X° ±0.5°								
>0-3	>3-18	>18-50	>50-120	Unit	Scale	Design Unit	Size	Part No.	
±0.12	±0.15	±0.3	±0.5	mm	—	Metric	A4		
Draw	Review	Approve	Material	Drawing No.			Part No.		
				Item	51146-NY				

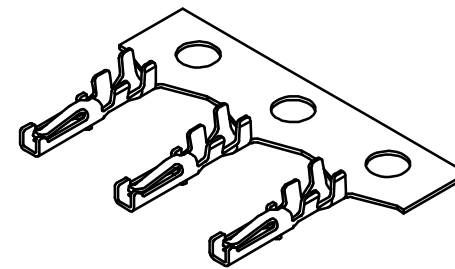
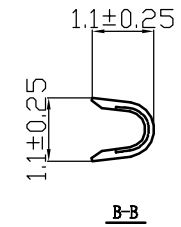
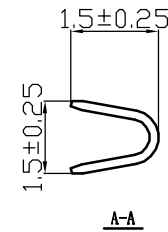
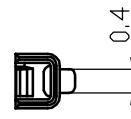
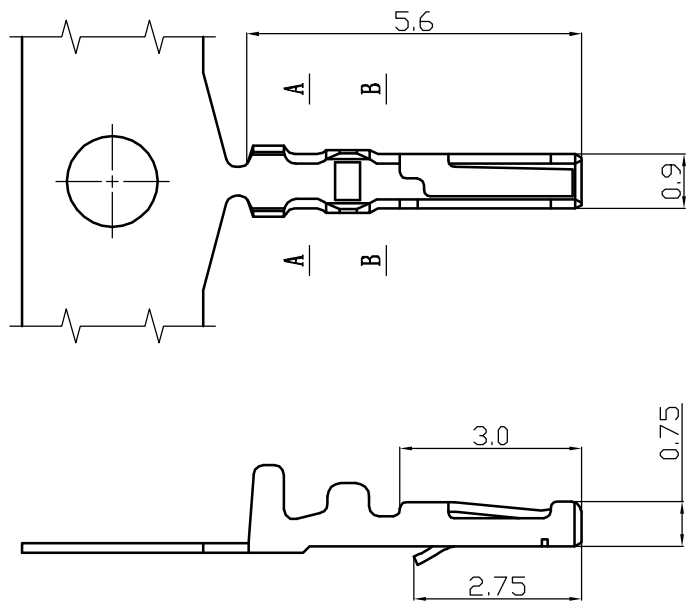
51146 Type Terminal



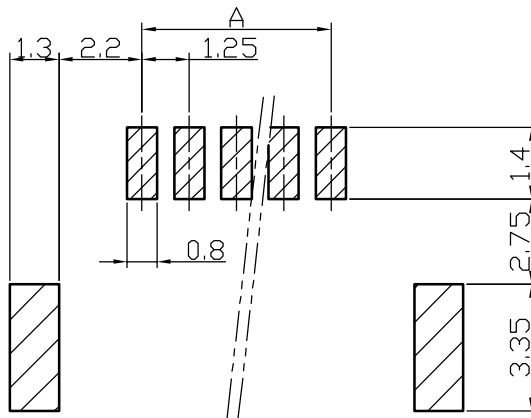
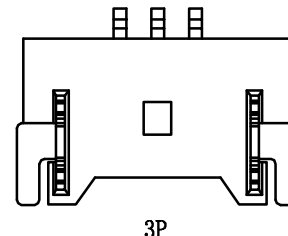
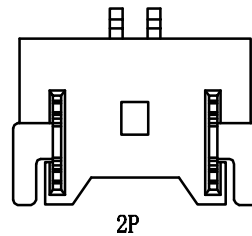
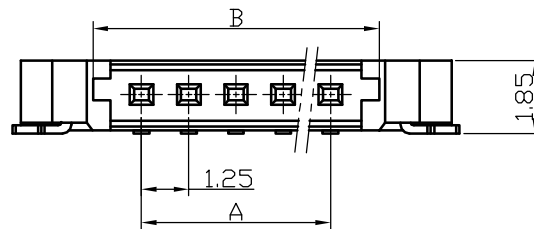
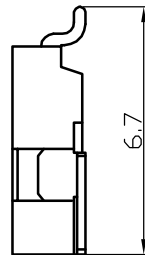
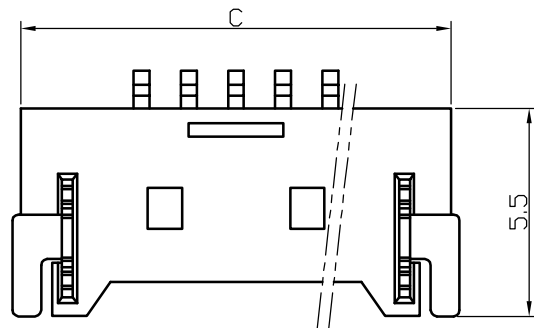

1	WB1253-TP2	Phosphor Bronze	1						
No.	Item/Material No.	Material	QTY	Remark					
Unmarked Tolerance		 Yueqing Hegxing Electronics Co., Ltd							
X. ° ±3° X. X° ±0.5°									
>0-3	>3-18	>18-50	>50-120	Unit	Scale	Design Unit	Size	Part No.	 
±0.12	±0.15	±0.3	±0.5	mm	—	Metric	A4		
Draw	Review	Approve	Material	Drawing No.			Part No.		
				Item	51146-T (216)				

51146 Type Wafer



Poles	Part No.		Dimensions		
			A	B	C
2	WB1253-SS02	51146-2AWB	1.25	3.85	7.65
3	WB1253-SS03	51146-3AWB	2.5	5.1	8.9
4	WB1253-SS04	51146-4AWB	3.75	6.35	10.15
5	WB1253-SS05	51146-5AWB	5	7.6	11.4
6	WB1253-SS06	51146-6AWB	6.25	8.85	12.65
7	WB1253-SS07	51146-7AWB	7.5	10.1	13.9
8	WB1253-SS08	51146-8AWB	8.75	11.35	15.15
9	WB1253-SS09	51146-9AWB	10	12.6	16.4
10	WB1253-SS10	51146-10AWB	11.25	13.85	17.65
11	WB1253-SS11	51146-11AWB	12.5	15.1	18.9
-	-	-	-	-	-
30	WB1253-SS30	51146-30AWB	36.25	38.85	42.65

3	Soldering Lug	Phosthor Bronze	2						
2	Pin	Phosthor Bronze	N						
1	Wafer	PA9T (UL94V-0)	1						
No.	Item/Material No.	Material	QTY	Remark					
Unmarked Tolerance		 Yueqing Hegxing Electronics Co., Ltd							
X. ° ±3° X. X° ±0.5°									
>0-3	>3-18	>18-50	>50-120	Unit	Scale	Design Unit	Size	Part No.	 
±0.12	±0.15	±0.3	±0.5	mm	—	Metric	A4		
Draw	Review	Approve	Material	Drawing No.		Part No.			
				Item	51146-NAWB-80				