

XHB Type Housing

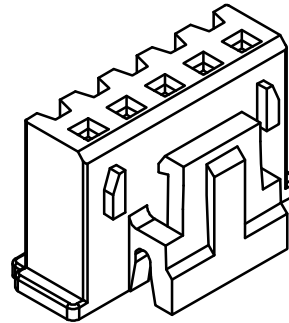
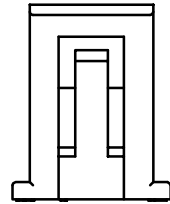
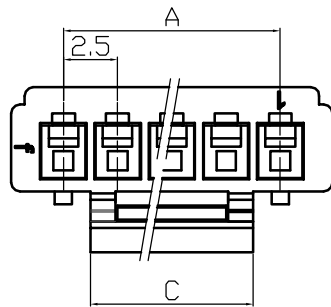
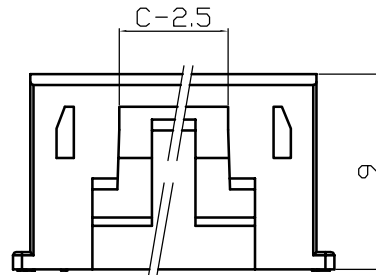
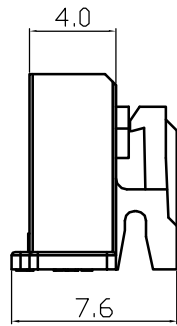
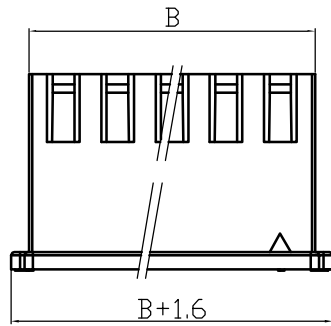
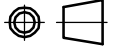

Poles	Part No.		Dimensions		
			A	B	C
2	WB2502-H02	XHB-2Y	2.5	5.7	3
3	WB2502-H03	XHB-3Y	5	8.2	4
4	WB2502-H04	XHB-4Y	7.5	10.7	5
5	WB2502-H05	XHB-5Y	10	13.2	7.5
6	WB2502-H06	XHB-6Y	12.5	15.7	10
7	WB2502-H07	XHB-7Y	15	18.2	12.5
8	WB2502-H08	XHB-8Y	17.5	20.7	12.5
9	WB2502-H09	XHB-9Y	20	23.2	12.5
10	WB2502-H10	XHB-10Y	22.5	25.7	12.5
11	WB2502-H11	XHB-11Y	25	28.2	12.5
-	-	-	-	-	-
20	WB2502-H20	XHB-20Y	47.5	50.7	12.5

1	Housing	PA66(UL94V-0/V-2)	1	White					
No.	Item/Material No.	Material	QTY	Remark					
Unmarked Tolerance		 Yueqing Hegxing Electronics Co., Ltd							
X. ° ±3° X. X° ±0.5°									
>0-3	>3-18	>18-50	>50-120	Unit	Scale	Design Unit	Size	Part No.	
±0.12	±0.15	±0.3	±0.5	mm	—	Metric	A4		
Draw	Review	Approve	Material	Drawing No.	Part No.				
				Item	XHB-NY				

XHB Type Housing

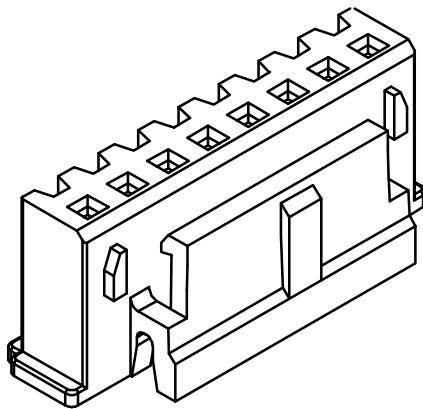
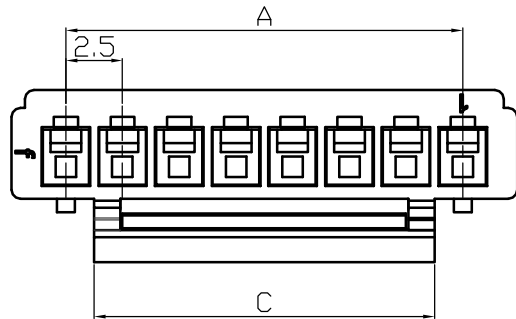
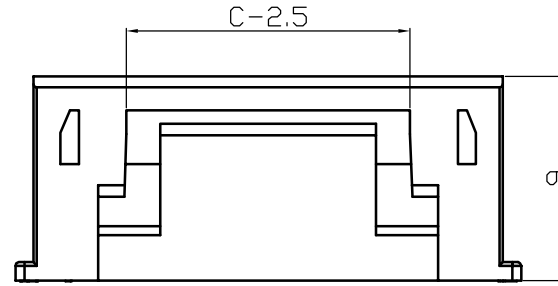
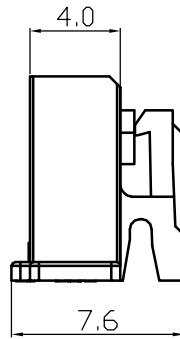
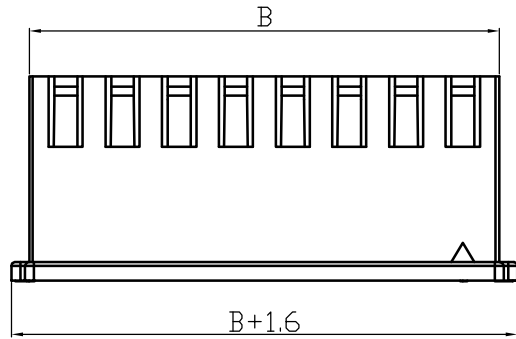

Poles	Part No.		Dimensions		
			A	B	C
8	WB2502-H08	XHB-8Y	17.5	22.3	17.5
9	WB2502-H09	XHB-9Y	20	24.8	17.5
10	WB2502-H10	XHB-10Y	22.5	27.3	17.5
11	WB2502-H11	XHB-11Y	25	29.8	17.5
12	WB2502-H12	XHB-12Y	27.5	32.3	17.5
13	WB2502-H13	XHB-13Y	30	34.8	17.5
14	WB2502-H14	XHB-14Y	32.5	37.3	17.5
15	WB2502-H15	XHB-15Y	35	39.8	17.5
16	WB2502-H16	XHB-16Y	37.5	42.3	17.5
17	WB2502-H17	XHB-17Y	40	44.8	17.5
18	WB2502-H18	XHB-18Y	42.5	47.3	17.5
19	WB2502-H19	XHB-19Y	45	49.8	17.5
20	WB2502-H20	XHB-20Y	47.5	52.3	17.5

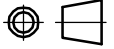
1	Housing	PA66(UL94V-0/V-2)	1	White					
No.	Item/Material No.	Material	QTY	Remark					
Unmarked Tolerance		 Yueqing Hegxing Electronics Co., Ltd							
X. ° ±3° X. X° ±0.5°									
>0-3	>3-18	>18-50	>50-120	Unit	Scale	Design Unit	Size	Part No.	
±0.12	±0.15	±0.3	±0.5	mm	—	Metric	A4		
Draw	Review	Approve	Material	Drawing No.	Part No.				
				Item	XHB-NY wide lock				

XH Type Terminal

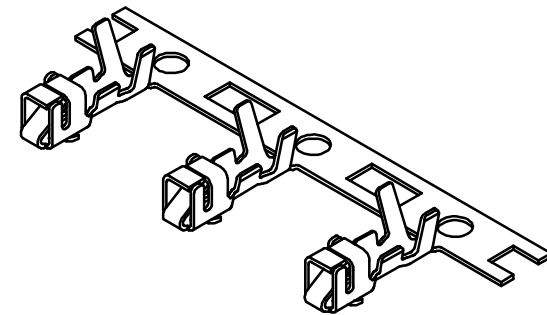
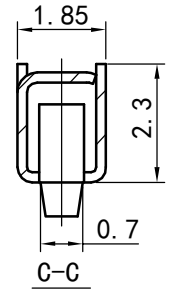
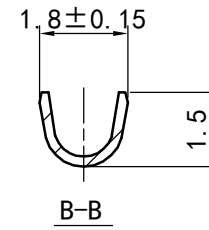
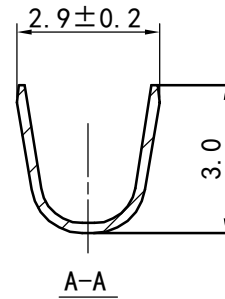
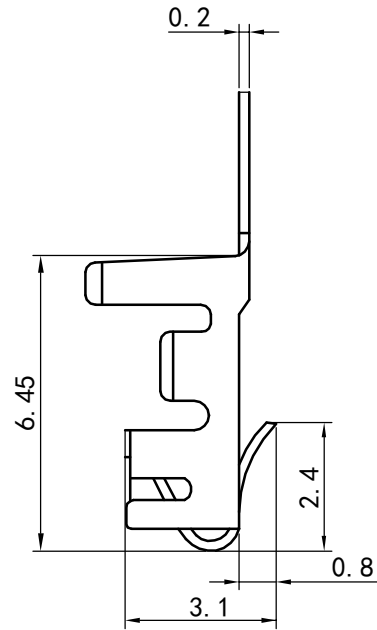
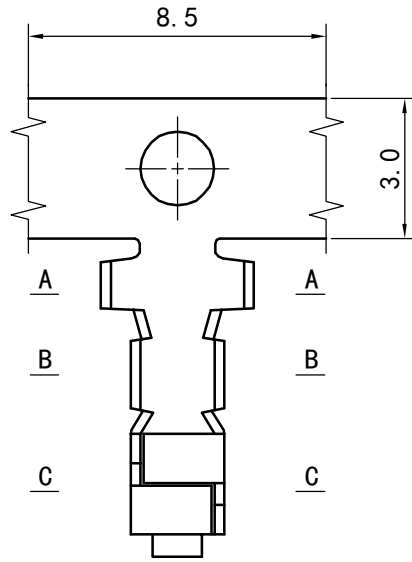

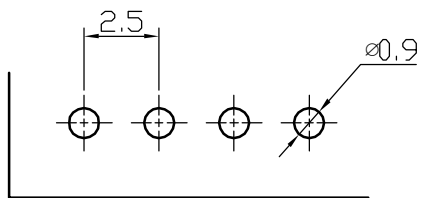
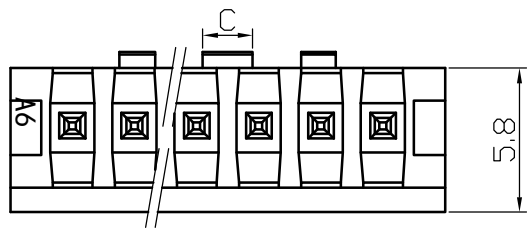
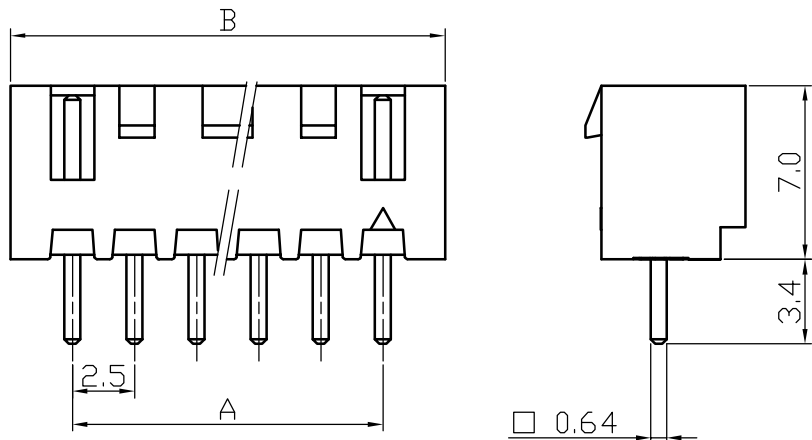

1	WB2501-T	Phosphor Bronze	1	
No.	Item/Material No.	Material	QTY	Remark
Unmarked Tolerance		 Yueqing Hegxing Electronics Co., Ltd		
X. ° ±3° X. X° ±0.5°				
>0-3	>3-18	>18-50	>50-120	Unit
±0.12	±0.15	±0.3	±0.5	Scale
		mm	Metric	Design Unit
			A4	Size
Draw	Review	Approve	Material	Part No.
		Drawing No.		
		Item	XH-T11	

XHB Type Wafer



PCB Layout

Poles	Part No.		Dimensions		
			A	B	C
2	WB2502-PT02	XHB-2A	2.5	7.5	1
3	WB2502-PT03	XHB-3A	5	10	1.2
4	WB2502-PT04	XHB-4A	7.5	12.5	2
5	WB2502-PT05	XHB-5A	10	15	2
6	WB2502-PT06	XHB-6A	12.5	17.5	8.6
7	WB2502-PT07	XHB-7A	15	20	11.1
8	WB2502-PT08	XHB-8A	17.5	22.5	13.6
9	WB2502-PT09	XHB-9A	20	25	16.1
10	WB2502-PT10	XHB-10A	22.5	27.5	18.6
11	WB2502-PT11	XHB-11A	25	30	21.1
-	-	-	-	-	-
20	WB2502-PT20	XHB-20A	47.5	52.5	43.6

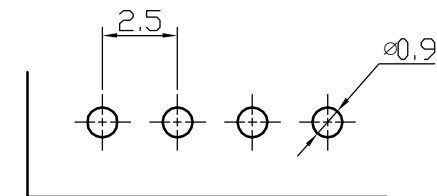
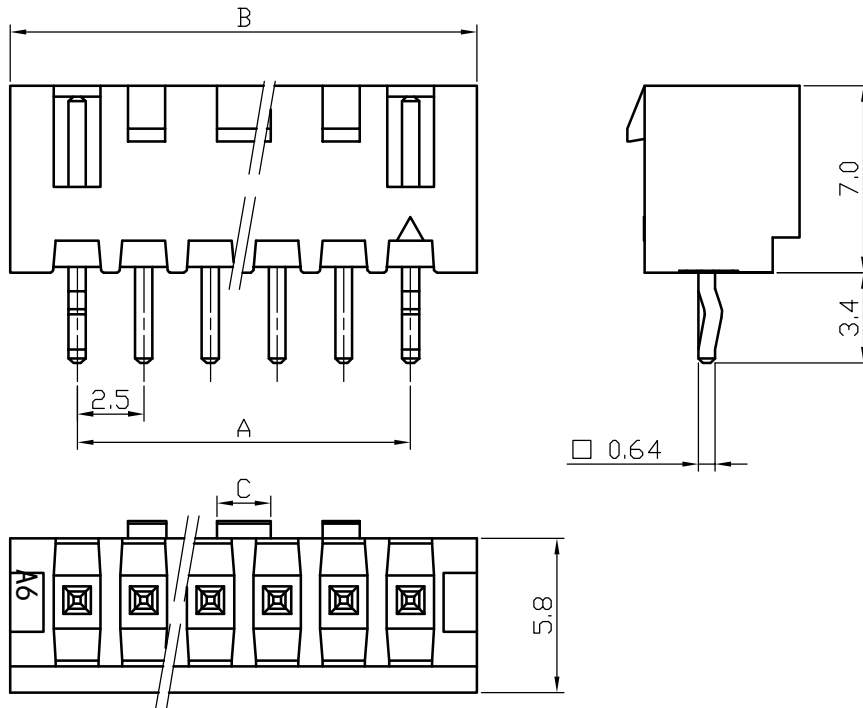

2	Pin	Tin Plated Brass	N						
1	Housing	PA9T (UL94V-0)	1						
No.	Item/Material No.	Material	QTY	Remark					
Unmarked Tolerance		 Yueqing Hegxing Electronics Co., Ltd							
X. ° ±3° X. X° ±0.5°									
>0-3	>3-18	>18-50	>50-120	Unit	Scale	Design Unit	Size	Part No.	 
±0.12	±0.15	±0.3	±0.5	mm	—	Metric	A4		
Draw	Review	Approve	Material	Drawing No.			Part No.		
				Item	XHB-NA				

XHB Type Wafer



PCB Layout

Poles	Part No.		Dimensions		
			A	B	C
2	WB2502-PT02-K	XHB-2A	2.5	7.5	1
3	WB2502-PT03-K	XHB-3A	5	10	1.2
4	WB2502-PT04-K	XHB-4A	7.5	12.5	2
5	WB2502-PT05-K	XHB-5A	10	15	2
6	WB2502-PT06-K	XHB-6A	12.5	17.5	8.6
7	WB2502-PT07-K	XHB-7A	15	20	11.1
8	WB2502-PT08-K	XHB-8A	17.5	22.5	13.6
9	WB2502-PT09-K	XHB-9A	20	25	16.1
10	WB2502-PT10-K	XHB-10A	22.5	27.5	18.6
11	WB2502-PT11-K	XHB-11A	25	30	21.1
-	-	-	-	-	-
20	WB2502-PT20-K	XHB-20A	47.5	52.5	43.6

2	Pin	Tin Plated Brass	N						
1	Housing	PA9T (UL94V-0)	1						
No.	Item/Material No.	Material	QTY	Remark					
Unmarked Tolerance		 Yueqing Hegxing Electronics Co., Ltd							
X. ° ±3° X. X° ±0.5°									
>0-3	>3-18	>18-50	>50-120	Unit	Scale	Design Unit	Size	Part No.	 
±0.12	±0.15	±0.3	±0.5	mm	—	Metric	A4		
Draw	Review	Approve	Material	Drawing No.		Part No.			
			Item	XHB-NA convex pin					

XHB Type Wafer

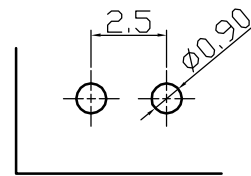
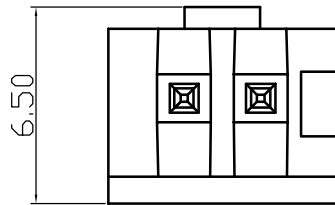
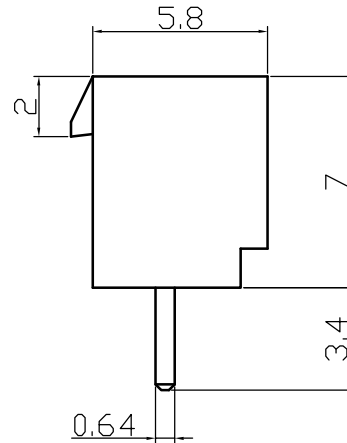
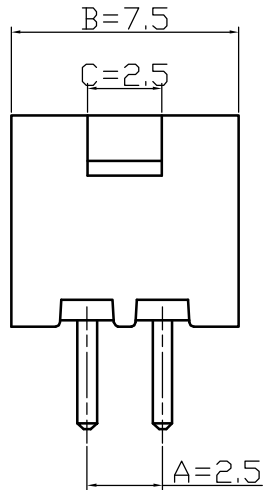

PCB Layout

Main Specifications:

- Poles: 2
- Rated current: 3.0 A AC/DC
- Rated voltage: 250 V AC/DC
- Temperature range: -25 ~ +85 °C
- Contact resistance: $\leq 10 \text{ m}\Omega$
- Insulation resistance: $\geq 1000 \text{ M}\Omega$
- Withstand voltage: 1000 V AC/minute
- Applicable wire: AWG #30 ~ #22
- Applicable PC board thickness: 1.6 mm

Poles	Part No.	Dimensions		
		A	B	C
2	WB2502-PT02-E XHB-2A	2.5	7.5	2.5

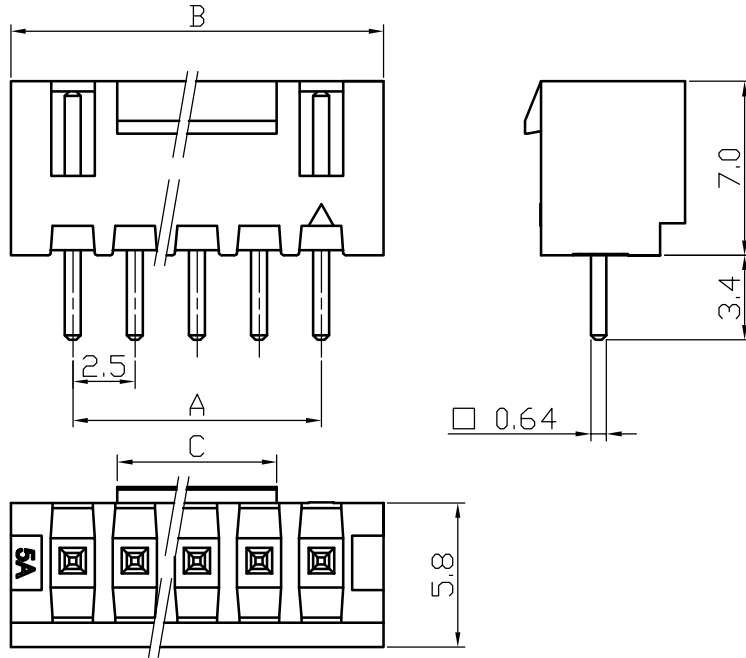

2	Pin	Tin Plated Brass	N						
1	Housing	PA9T (UL94V-0)	1						
No.	Item/Material No.	Material	QTY	Remark					
Unmarked Tolerance		Yueqing Hegxing Electronics Co., Ltd							
X. ° ±3° X. X° ±0.5°									
>0-3	>3-18	>18-50	>50-120	Unit	Scale	Design Unit	Size	Part No.	
±0.12	±0.15	±0.3	±0.5	mm	—	Metric	A4		
Draw	Review	Approve	Material	Drawing No.	Part No.				
				Item	XHB-NA enclosure				

XHB Type Wafer



Poles	Part No.		Dimensions		
			A	B	C
2	WB2502-PTB02	XHB-2A	2.5	7.5	1
3	WB2502-PTB03	XHB-3A	5	10	1.2
4	WB2502-PTB04	XHB-4A	7.5	12.5	2
5	WB2502-PTB05	XHB-5A	10	15	2
6	WB2502-PTB06	XHB-6A	12.5	17.5	8.6
7	WB2502-PTB07	XHB-7A	15	20	11.1
8	WB2502-PTB08	XHB-8A	17.5	22.5	13.6
9	WB2502-PTB09	XHB-9A	20	25	16.1
10	WB2502-PTB10	XHB-10A	22.5	27.5	18.6
11	WB2502-PTB11	XHB-11A	25	30	21.1
-	-	-	-	-	-
20	WB2502-PTB20	XHB-20A	47.5	52.5	43.6

PCB Layout

2	Pin	Tin Plated Brass	N						
1	Housing	PA9T (UL94V-0)	1						
No.	Item/Material No.	Material	QTY	Remark					
Unmarked Tolerance		 Yueqing Hegxing Electronics Co., Ltd							
X. ° ±3° X. X° ±0.5°									
>0-3	>3-18	>18-50	>50-120	Unit	Scale	Design Unit	Size	Part No.	 
±0.12	±0.15	±0.3	±0.5	mm	—	Metric	A4		
Draw	Review	Approve	Material	Drawing No.				Part No.	
				Item	XHB-NA wide lock				

XHB Type Wafer

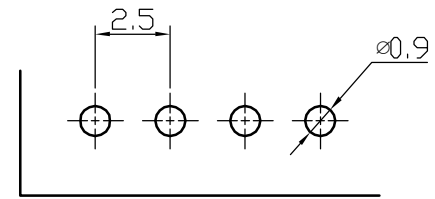
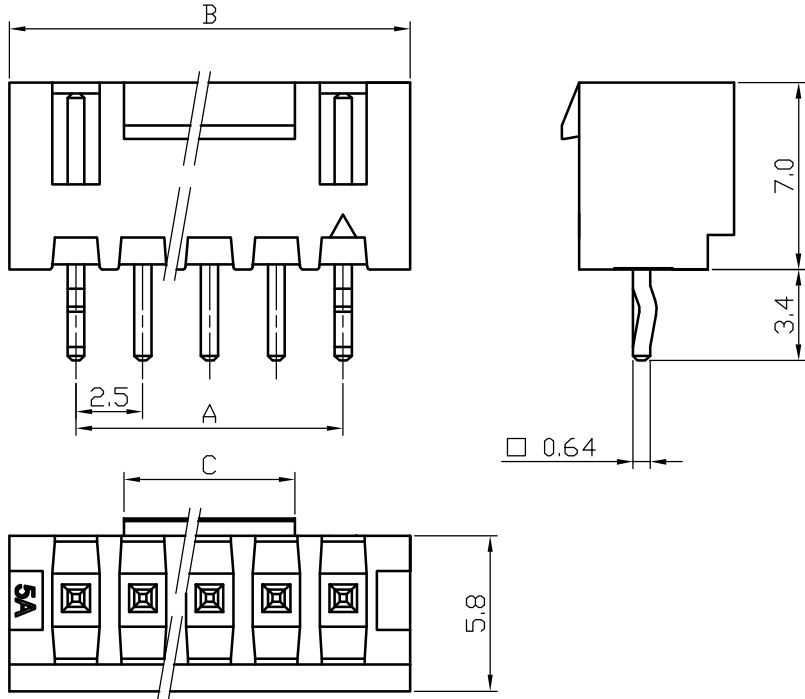

PCB Layout

Poles	Part No.		Dimensions		
			A	B	C
2	WB2502-PTB02-K	XHB-2A	2.5	7.5	1
3	WB2502-PTB03-K	XHB-3A	5	10	1.2
4	WB2502-PTB04-K	XHB-4A	7.5	12.5	2
5	WB2502-PTB05-K	XHB-5A	10	15	2
6	WB2502-PTB06-K	XHB-6A	12.5	17.5	8.6
7	WB2502-PTB07-K	XHB-7A	15	20	11.1
8	WB2502-PTB08-K	XHB-8A	17.5	22.5	13.6
9	WB2502-PTB09-K	XHB-9A	20	25	16.1
10	WB2502-PTB10-K	XHB-10A	22.5	27.5	18.6
11	WB2502-PTB11-K	XHB-11A	25	30	21.1
-	-	-	-	-	-
20	WB2502-PTB20-K	XHB-20A	47.5	52.5	43.6

2	Pin	Tin Plated Brass	N						
1	Housing	PA9T (UL94V-0)	1						
No.	Item/Material No.	Material	QTY	Remark					
Unmarked Tolerance		Yueqing Hegxing Electronics Co., Ltd							
X. ° ±3° X. X° ±0.5°									
>0-3	>3-18	>18-50	>50-120	Unit	Scale	Design Unit	Size	Part No.	
±0.12	±0.15	±0.3	±0.5	mm	—	Metric	A4		
Draw	Review	Approve	Material	Drawing No.	Part No.				
				Item	XHB-NA wide lock & convex pin				

XHB Type Wafer

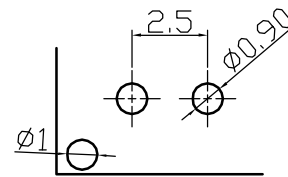
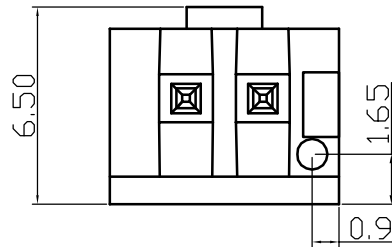
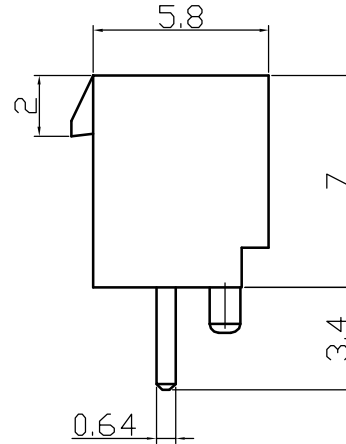
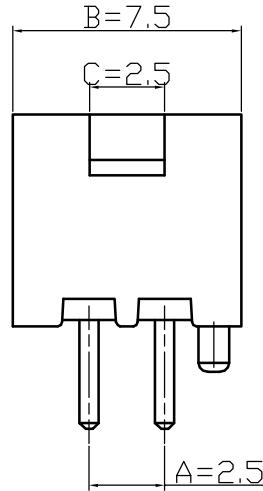

PCB Layout

Main Specifications:

- Poles: 2
- Rated current: 3.0 A AC/DC
- Rated voltage: 250 V AC/DC
- Temperature range: -25 ~ +85 °C
- Contact resistance: ≤ 10 m Ω
- Insulation resistance: ≥ 1000 M Ω
- Withstand voltage: 1000 V AC/minute
- Applicable wire: AWG #30 ~ #22
- Applicable PC board thickness: 1.6 mm

Poles	Part No.		Dimensions		
			A	B	C
2	WB2502-PTB02-E	XHB-2AD	2.5	7.5	2.5

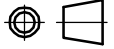
2	Pin	Tin Plated Brass	N						
1	Housing	PA9T (UL94V-0)	1						
No.	Item/Material No.	Material	QTY	Remark					
Unmarked Tolerance		 Yueqing Hegxing Electronics Co., Ltd							
X. ° $\pm 3^\circ$ X. X° $\pm 0.5^\circ$									
>0-3	>3-18	>18-50	>50-120	Unit	Scale	Design Unit	Size	Part No.	
± 0.12	± 0.15	± 0.3	± 0.5	mm	—	Metric	A4		
Draw	Review	Approve	Material	Drawing No.		Part No.			
				Item	XHB-NAD enclosure				

XHB Type Wafer

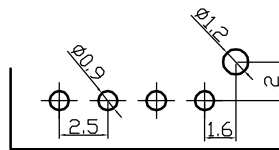
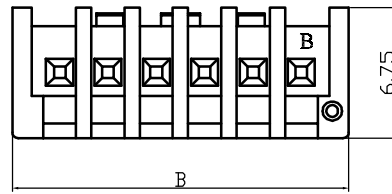
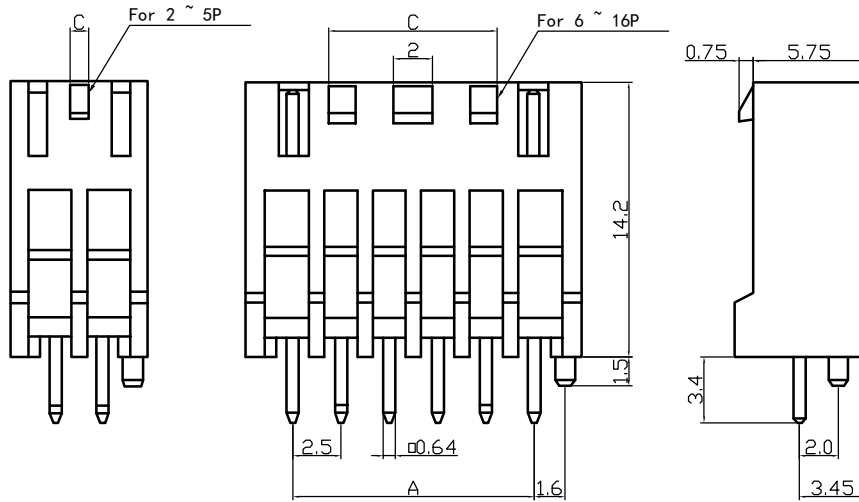

PCB Layout

Poles	Part No.		Dimensions		
			A	B	C
2	WB2502-PTB02-BH	XHB-2A-BH	2.5	7.4	1
3	WB2502-PTB03-BH	XHB-3A-BH	5	9.9	1.2
4	WB2502-PTB04-BH	XHB-4A-BH	7.5	12.4	2
5	WB2502-PTB05-BH	XHB-5A-BH	10	14.9	2
6	WB2502-PTB06-BH	XHB-6A-BH	12.5	17.4	8.6
7	WB2502-PTB07-BH	XHB-7A-BH	15	19.9	11.1
8	WB2502-PTB08-BH	XHB-8A-BH	17.5	22.4	13.6
9	WB2502-PTB09-BH	XHB-9A-BH	20	24.9	16.1
10	WB2502-PTB10-BH	XHB-10A-BH	22.5	27.4	18.6
11	WB2502-PTB11-BH	XHB-11A-BH	25	29.9	21.1
-	-	-	-	-	-
16	WB2502-PTB16-BH	XHB-16A-BH	37.5	42.4	33.7

2	Pin	Tin Plated Brass	N						
1	Housing	PA9T (UL94V-0)	1						
No.	Item/Material No.	Material	QTY	Remark					
Unmarked Tolerance		Yueqing Hegxing Electronics Co., Ltd							
X. ° ±3° X. X° ±0.5°									
>0-3	>3-18	>18-50	>50-120	Unit	Scale	Design Unit	Size	Part No.	
±0.12	±0.15	±0.3	±0.5	mm	—	Metric	A4		
Draw	Review	Approve	Material	Drawing No.	Part No.				
				Item	XHB-NA-BH				

XHB Type Wafer

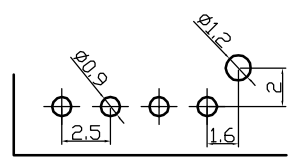
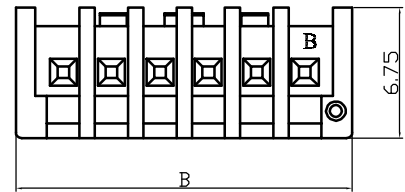
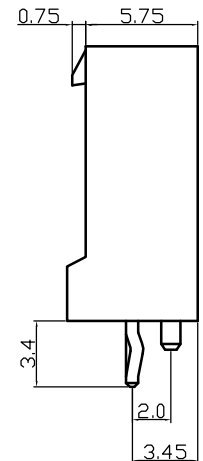
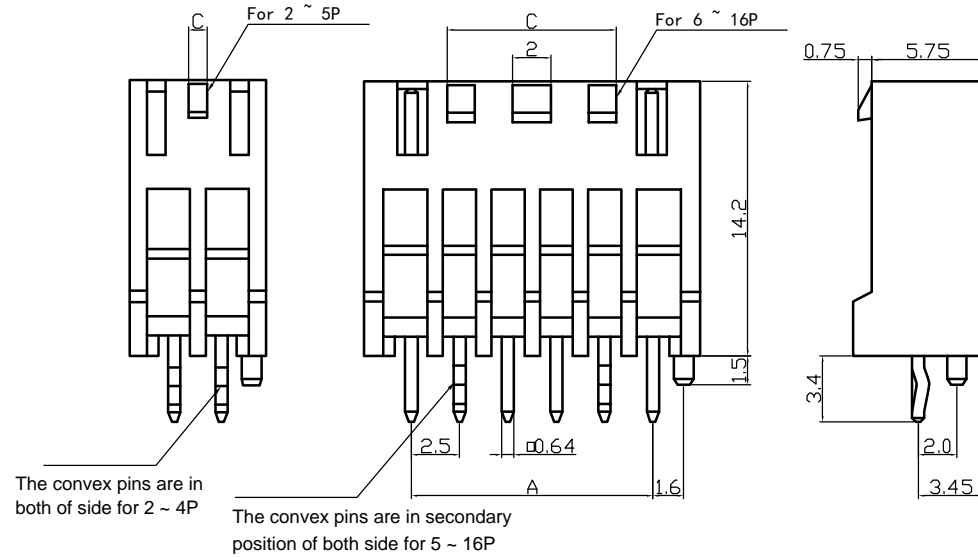

PCB Layout

Poles	Part No.		Dimensions		
			A	B	C
2	WB2502-PTB02-BH-K	XHB-2A-BH	2.5	7.4	1
3	WB2502-PTB03-BH-K	XHB-3A-BH	5	9.9	1.2
4	WB2502-PTB04-BH-K	XHB-4A-BH	7.5	12.4	2
5	WB2502-PTB05-BH-K	XHB-5A-BH	10	14.9	2
6	WB2502-PTB06-BH-K	XHB-6A-BH	12.5	17.4	8.6
7	WB2502-PTB07-BH-K	XHB-7A-BH	15	19.9	11.1
8	WB2502-PTB08-BH-K	XHB-8A-BH	17.5	22.4	13.6
9	WB2502-PTB09-BH-K	XHB-9A-BH	20	24.9	16.1
10	WB2502-PTB10-BH-K	XHB-10A-BH	22.5	27.4	18.6
11	WB2502-PTB11-BH-K	XHB-11A-BH	25	29.9	21.1
-	-	-	-	-	-
16	WB2502-PTB16-BH-K	XHB-16A-BH	37.5	42.4	33.7

2	Pin	Tin Plated Brass	N						
1	Housing	PA9T (UL94V-0)	1						
No.	Item/Material No.	Material	QTY	Remark					
Unmarked Tolerance		Yueqing Hegxing Electronics Co., Ltd							
X. ° ±3° X. X° ±0.5°									
>0-3	>3-18	>18-50	>50-120	Unit	Scale	Design Unit	Size	Part No.	
±0.12	±0.15	±0.3	±0.5	mm	—	Metric	A4		
Draw	Review	Approve	Material	Drawing No.	Part No.				
				Item	XHB-NA-BH convex pin				

XHB Type Wafer

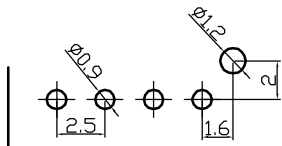
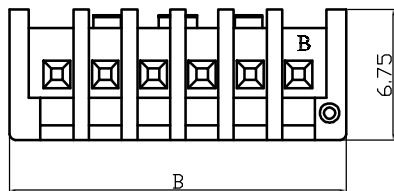
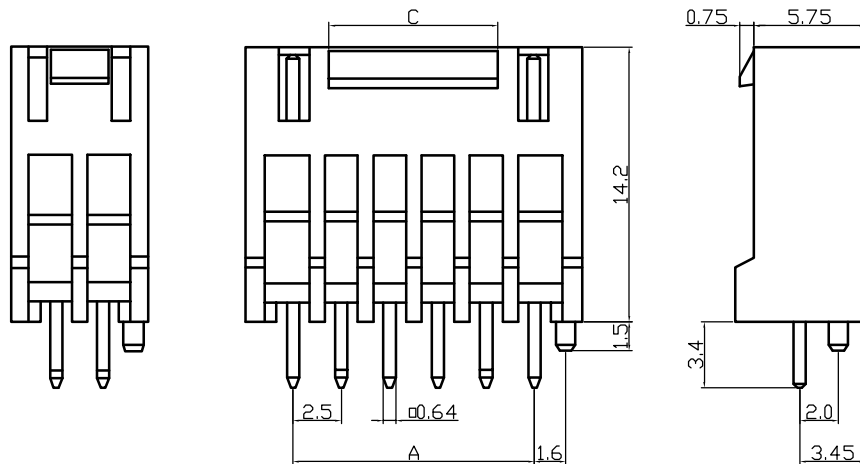

PCB Layout

Poles	Part No.		Dimensions		
			A	B	C
2	WB2502-PTB02-BH-K	XHB-2A-BH	2.5	7.4	1
3	WB2502-PTB03-BH-K	XHB-3A-BH	5	9.9	1.2
4	WB2502-PTB04-BH-K	XHB-4A-BH	7.5	12.4	2
5	WB2502-PTB05-BH-K	XHB-5A-BH	10	14.9	2
6	WB2502-PTB06-BH-K	XHB-6A-BH	12.5	17.4	8.6
7	WB2502-PTB07-BH-K	XHB-7A-BH	15	19.9	11.1
8	WB2502-PTB08-BH-K	XHB-8A-BH	17.5	22.4	13.6
9	WB2502-PTB09-BH-K	XHB-9A-BH	20	24.9	16.1
10	WB2502-PTB10-BH-K	XHB-10A-BH	22.5	27.4	18.6
11	WB2502-PTB11-BH-K	XHB-11A-BH	25	29.9	21.1
-	-	-	-	-	-
16	WB2502-PTB16-BH-K	XHB-16A-BH	37.5	42.4	33.7

2	Pin	Tin Plated Brass	N						
1	Housing	PA9T (UL94V-0)	1						
No.	Item/Material No.	Material	QTY	Remark					
Unmarked Tolerance		Yueqing Hegxing Electronics Co., Ltd							
X. ° ±3° X. X° ±0.5°									
>0-3	>3-18	>18-50	>50-120	Unit	Scale	Design Unit	Size	Part No.	
±0.12	±0.15	±0.3	±0.5	mm	—	Metric	A4		
Draw	Review	Approve	Material	Drawing No.	Part No.				
				Item	XHB-NA-BH wide lock				

XHB Type Wafer

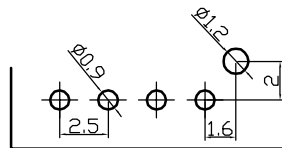
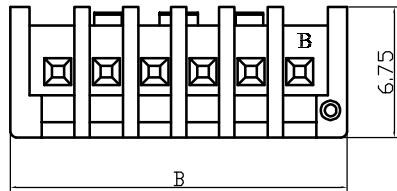
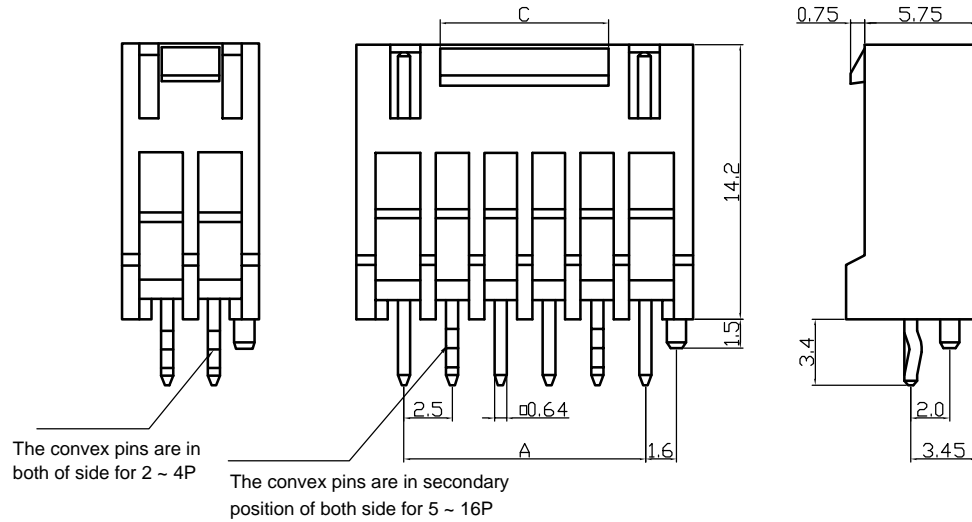

PCB Layout

Poles	Part No.		Dimensions		
			A	B	C
2	WB2502-PTB02-BH-K	XHB-2A-BH	2.5	7.4	1
3	WB2502-PTB03-BH-K	XHB-3A-BH	5	9.9	1.2
4	WB2502-PTB04-BH-K	XHB-4A-BH	7.5	12.4	2
5	WB2502-PTB05-BH-K	XHB-5A-BH	10	14.9	2
6	WB2502-PTB06-BH-K	XHB-6A-BH	12.5	17.4	8.6
7	WB2502-PTB07-BH-K	XHB-7A-BH	15	19.9	11.1
8	WB2502-PTB08-BH-K	XHB-8A-BH	17.5	22.4	13.6
9	WB2502-PTB09-BH-K	XHB-9A-BH	20	24.9	16.1
10	WB2502-PTB10-BH-K	XHB-10A-BH	22.5	27.4	18.6
11	WB2502-PTB11-BH-K	XHB-11A-BH	25	29.9	21.1
-	-	-	-	-	-
16	WB2502-PTB16-BH-K	XHB-16A-BH	37.5	42.4	33.7

2	Pin	Tin Plated Brass	N						
1	Housing	PA9T (UL94V-0)	1						
No.	Item/Material No.	Material	QTY	Remark					
Unmarked Tolerance		Yueqing Hegxing Electronics Co., Ltd							
X. ° ±3° X. X° ±0.5°									
>0-3	>3-18	>18-50	>50-120	Unit	Scale	Design Unit	Size	Part No.	
±0.12	±0.15	±0.3	±0.5	mm	—	Metric	A4		
Draw	Review	Approve	Material	Drawing No.	Part No.				
				Item	XHB-NA-BH wide lock & convex pin				

XHB Type Wafer

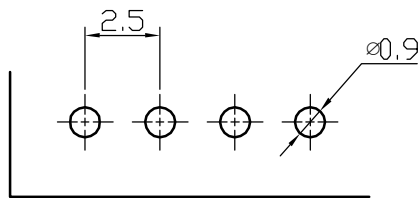
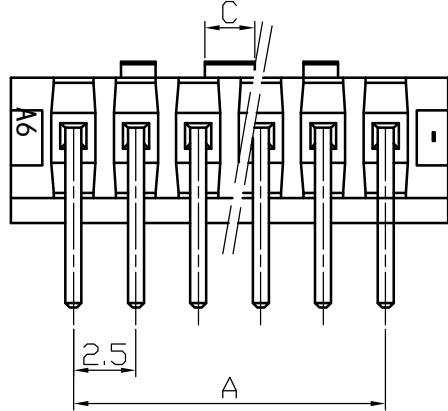
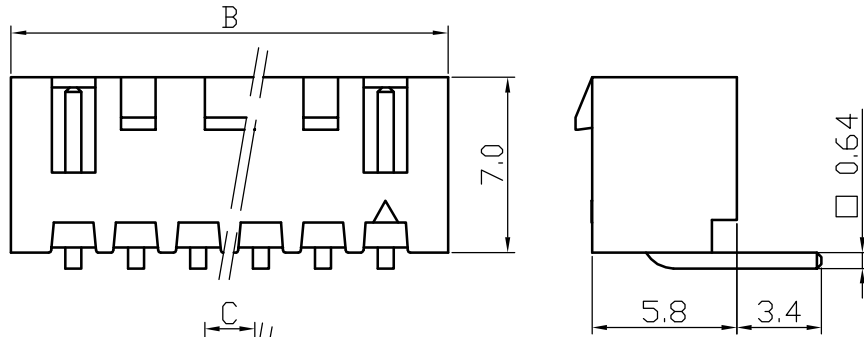

PCB Layout

Poles	Part No.		Dimensions		
			A	B	C
2	WB2502-PS02	XHB-2AW	2.5	7.5	1
3	WB2502-PS03	XHB-3AW	5	10	1.2
4	WB2502-PS04	XHB-4AW	7.5	12.4	2
5	WB2502-PS05	XHB-5AW	10	14.9	2
6	WB2502-PS06	XHB-6AW	12.5	17.4	8.6
7	WB2502-PS07	XHB-7AW	15	19.9	11.1
8	WB2502-PS08	XHB-8AW	17.5	22.4	13.6
9	WB2502-PS09	XHB-9AW	20	24.9	16.1
10	WB2502-PS10	XHB-10AW	22.5	27.4	18.6
11	WB2502-PS11	XHB-11AW	25	29.9	21.1
-	-	-	-	-	-
20	WB2502-PS20	XHB-20AW	47.5	52.5	43.6

2	Pin	Tin Plated Brass	N						
1	Housing	PA9T (UL94V-0)	1						
No.	Item/Material No.	Material	QTY	Remark					
Unmarked Tolerance		Yueqing Hegxing Electronics Co., Ltd							
X. ° ±3° X. X° ±0.5°									
>0-3	>3-18	>18-50	>50-120	Unit	Scale	Design Unit	Size	Part No.	
±0.12	±0.15	±0.3	±0.5	mm	—	Metric	A4		
Draw	Review	Approve	Material	Drawing No.		Part No.			
			Item	XHB-NAW					

XHB Type Wafer

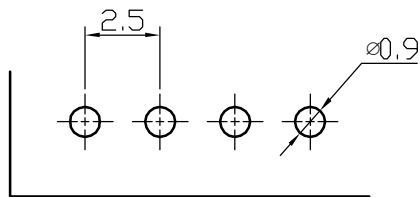
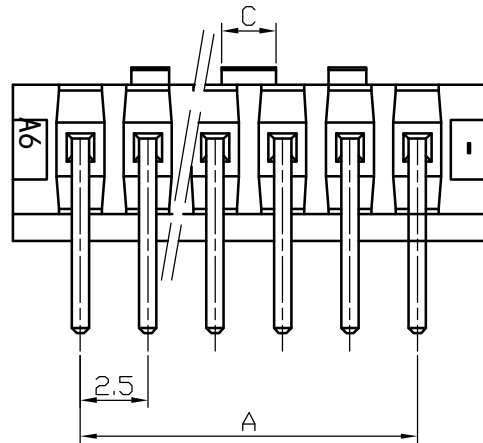
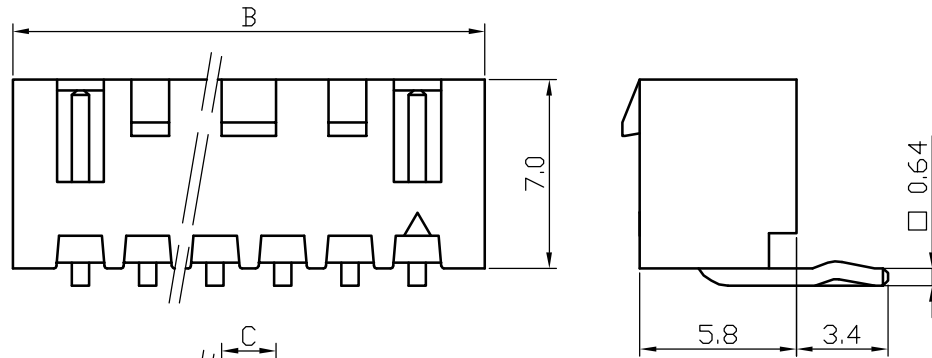

PCB Layout

Poles	Part No.		Dimensions		
			A	B	C
2	WB2502-PS02-K	XHB-2AW	2.5	7.5	1
3	WB2502-PS03-K	XHB-3AW	5	10	1.2
4	WB2502-PS04-K	XHB-4AW	7.5	12.4	2
5	WB2502-PS05-K	XHB-5AW	10	14.9	2
6	WB2502-PS06-K	XHB-6AW	12.5	17.4	8.6
7	WB2502-PS07-K	XHB-7AW	15	19.9	11.1
8	WB2502-PS08-K	XHB-8AW	17.5	22.4	13.6
9	WB2502-PS09-K	XHB-9AW	20	24.9	16.1
10	WB2502-PS10-K	XHB-10AW	22.5	27.4	18.6
11	WB2502-PS11-K	XHB-11AW	25	29.9	21.1
-	-	-	-	-	-
20	WB2502-PS20-K	XHB-20AW	47.5	52.5	43.6

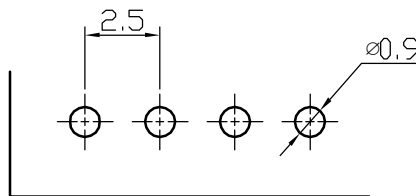
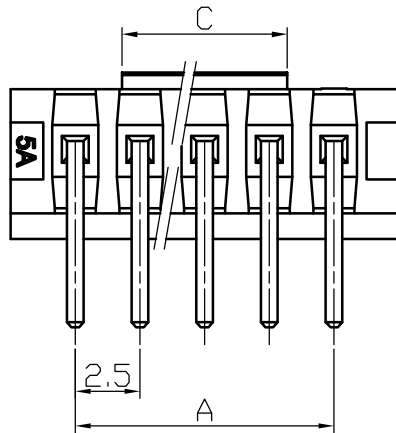
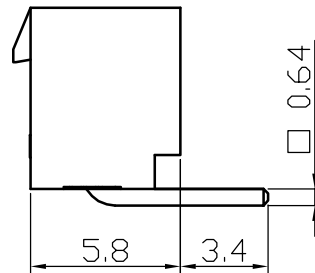
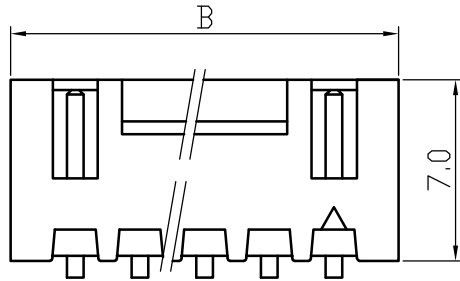

2	Pin	Tin Plated Brass	N						
1	Housing	PA9T (UL94V-0)	1						
No.	Item/Material No.	Material	QTY	Remark					
Unmarked Tolerance		Yueqing Hegxing Electronics Co., Ltd							
X. ° ±3° X. X° ±0.5°									
>0-3	>3-18	>18-50	>50-120	Unit	Scale	Design Unit	Size	Part No.	
±0.12	±0.15	±0.3	±0.5	mm	—	Metric	A4		
Draw	Review	Approve	Material	Drawing No.	Part No.				
				Item	XHB-NAW convex pin				

XHB Type Wafer



PCB Layout

Poles	Part No.		Dimensions		
			A	B	C
2	WB2502-PSB02	XHB-2AW	2.5	7.5	1
3	WB2502-PSB03	XHB-3AW	5	10	1.2
4	WB2502-PSB04	XHB-4AW	7.5	12.4	2
5	WB2502-PSB05	XHB-5AW	10	14.9	2
6	WB2502-PSB06	XHB-6AW	12.5	17.4	8.6
7	WB2502-PSB07	XHB-7AW	15	19.9	11.1
8	WB2502-PSB08	XHB-8AW	17.5	22.4	13.6
9	WB2502-PSB09	XHB-9AW	20	24.9	16.1
10	WB2502-PSB10	XHB-10AW	22.5	27.4	18.6
11	WB2502-PSB11	XHB-11AW	25	29.9	21.1
-	-	-	-	-	-
20	WB2502-PSB20	XHB-20AW	47.5	52.5	43.6

2	Pin	Tin Plated Brass	N						
1	Housing	PA9T (UL94V-0)	1						
No.	Item/Material No.	Material	QTY	Remark					
Unmarked Tolerance		 Yueqing Hegxing Electronics Co., Ltd							
X. ° ±3° X. X° ±0.5°									
>0-3	>3-18	>18-50	>50-120	Unit	Scale	Design Unit	Size	Part No.	 
±0.12	±0.15	±0.3	±0.5	mm	—	Metric	A4		
Draw	Review	Approve	Material	Drawing No.	Part No.				
				Item	XHB-NAW wide lock				

XHB Type Wafer

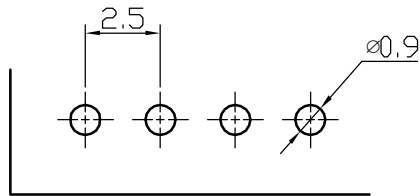
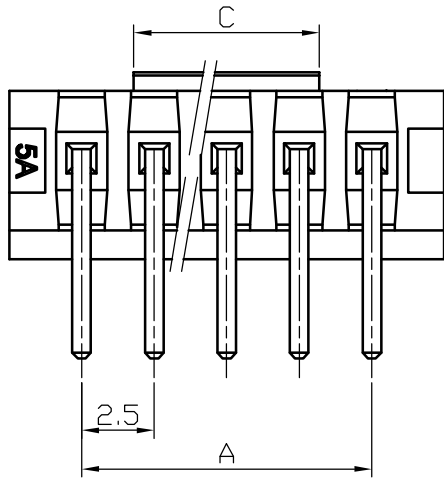
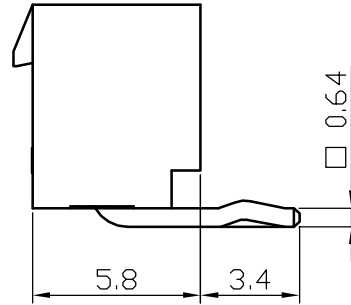
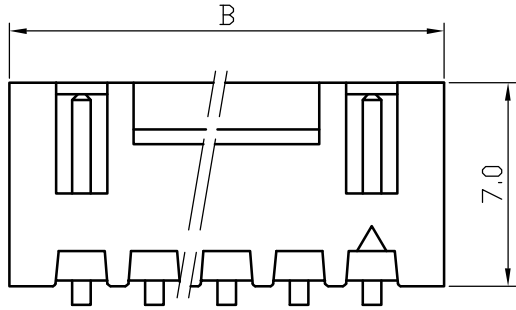

PCB Layout

Poles	Part No.		Dimensions		
			A	B	C
2	WB2502-PSB02-K	XHB-2AW	2.5	7.5	1
3	WB2502-PSB03-K	XHB-3AW	5	10	1.2
4	WB2502-PSB04-K	XHB-4AW	7.5	12.4	2
5	WB2502-PSB05-K	XHB-5AW	10	14.9	2
6	WB2502-PSB06-K	XHB-6AW	12.5	17.4	8.6
7	WB2502-PSB07-K	XHB-7AW	15	19.9	11.1
8	WB2502-PSB08-K	XHB-8AW	17.5	22.4	13.6
9	WB2502-PSB09-K	XHB-9AW	20	24.9	16.1
10	WB2502-PSB10-K	XHB-10AW	22.5	27.4	18.6
11	WB2502-PSB11-K	XHB-11AW	25	29.9	21.1
-	-	-	-	-	-
20	WB2502-PSB20-K	XHB-20AW	47.5	52.5	43.6

2	Pin	Tin Plated Brass	N						
1	Housing	PA9T (UL94V-0)	1						
No.	Item/Material No.	Material	QTY	Remark					
Unmarked Tolerance		Yueqing Hegxing Electronics Co., Ltd							
X. ° ±3° X. X° ±0.5°									
>0-3	>3-18	>18-50	>50-120	Unit	Scale	Design Unit	Size	Part No.	
±0.12	±0.15	±0.3	±0.5	mm	—	Metric	A4		
Draw	Review	Approve	Material	Drawing No.	Part No.				
			Item	XHB-NAW wide lock & convex pin					

XHB Type Wafer

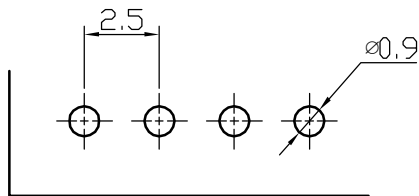
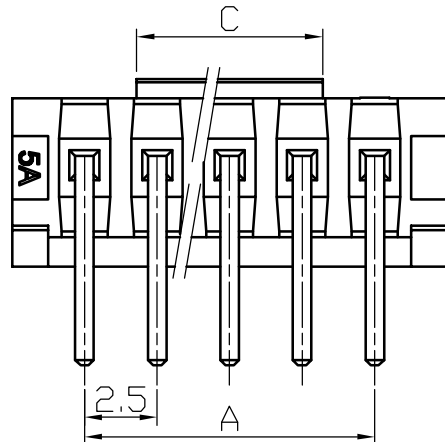
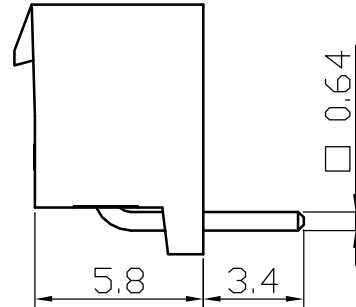
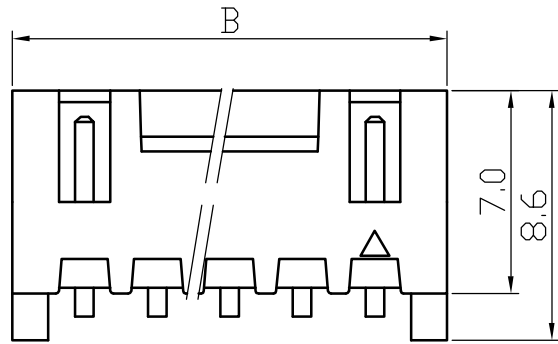

PCB Layout

Poles	Part No.		Dimensions		
			A	B	C
2	WB2502-PSC02	XHB-2AWD	2.5	7.5	1
3	WB2502-PSC03	XHB-3AWD	5	10	1.2
4	WB2502-PSC04	XHB-4AWD	7.5	12.4	2
5	WB2502-PSC05	XHB-5AWD	10	14.9	2
6	WB2502-PSC06	XHB-6AWD	12.5	17.4	8.6
7	WB2502-PSC07	XHB-7AWD	15	19.9	11.1
8	WB2502-PSC08	XHB-8AWD	17.5	22.4	13.6
9	WB2502-PSC09	XHB-9AWD	20	24.9	16.1
10	WB2502-PSC10	XHB-10AWD	22.5	27.4	18.6
11	WB2502-PSC11	XHB-11AWD	25	29.9	21.1
-	-	-	-	-	-
20	WB2502-PSC20	XHB-20AWD	47.5	52.5	43.6

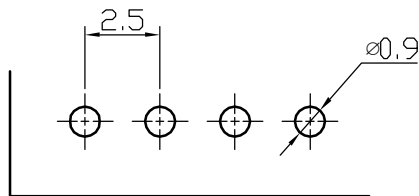
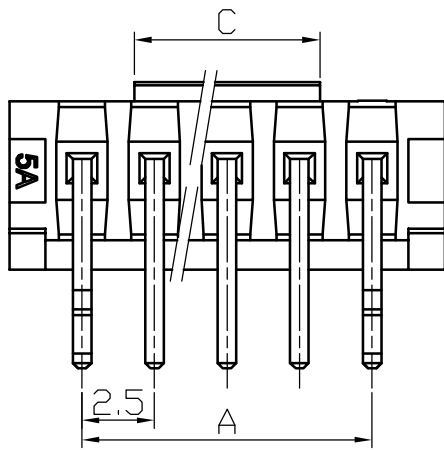
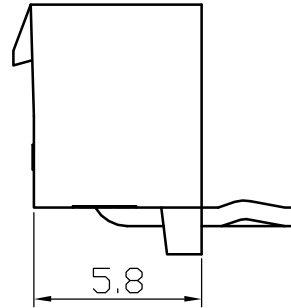
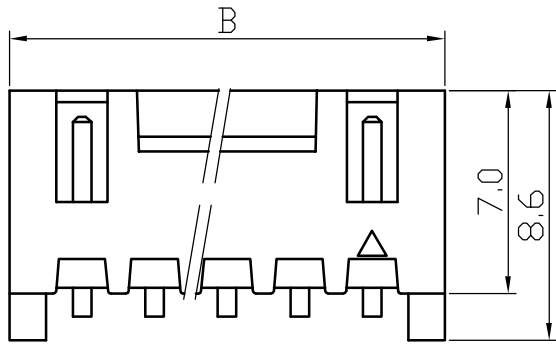

2	Pin	Tin Plated Brass	N						
1	Housing	PA9T (UL94V-0)	1						
No.	Item/Material No.	Material	QTY	Remark					
Unmarked Tolerance		Yueqing Hegxing Electronics Co., Ltd							
X. ° ±3° X. X° ±0.5°									
>0-3	>3-18	>18-50	>50-120	Unit	Scale	Design Unit	Size	Part No.	
±0.12	±0.15	±0.3	±0.5	mm	—	Metric	A4		
Draw	Review	Approve	Material	Drawing No.	Part No.				
			Item	XHB-NAWD wide lock					

XHB Type Wafer



PCB Layout

Poles	Part No.		Dimensions		
			A	B	C
2	WB2502-PSC02-K	XHB-2AWD	2.5	7.5	1
3	WB2502-PSC03-K	XHB-3AWD	5	10	1.2
4	WB2502-PSC04-K	XHB-4AWD	7.5	12.4	2
5	WB2502-PSC05-K	XHB-5AWD	10	14.9	2
6	WB2502-PSC06-K	XHB-6AWD	12.5	17.4	8.6
7	WB2502-PSC07-K	XHB-7AWD	15	19.9	11.1
8	WB2502-PSC08-K	XHB-8AWD	17.5	22.4	13.6
9	WB2502-PSC09-K	XHB-9AWD	20	24.9	16.1
10	WB2502-PSC10-K	XHB-10AWD	22.5	27.4	18.6
11	WB2502-PSC11-K	XHB-11AWD	25	29.9	21.1
-	-	-	-	-	-
20	WB2502-PSC20-K	XHB-20AWD	47.5	52.5	43.6

2	Pin	Tin Plated Brass	N						
1	Housing	PA9T (UL94V-0)	1						
No.	Item/Material No.	Material	QTY	Remark					
Unmarked Tolerance		 Yueqing Hegxing Electronics Co., Ltd							
X. ° ±3°	X. X° ±0.5°								
>0-3	>3-18	>18-50	>50-120	Unit	Scale	Design Unit	Size	Part No.	 
±0.12	±0.15	±0.3	±0.5	mm	—	Metric	A4		
Draw	Review	Approve	Material	Drawing No.	Part No.				
			Item	XHB-NAWD wide lock & convex pin					