

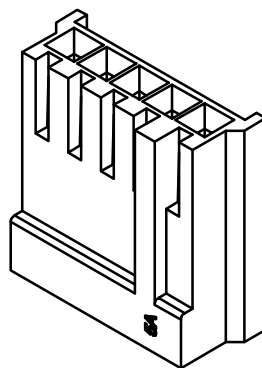

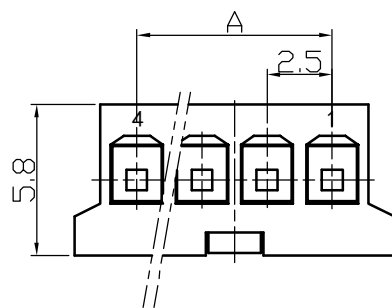

EI Type Housing

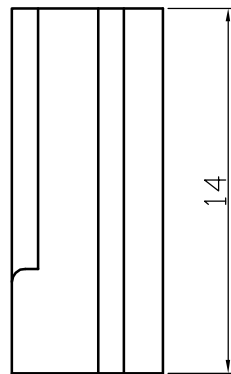
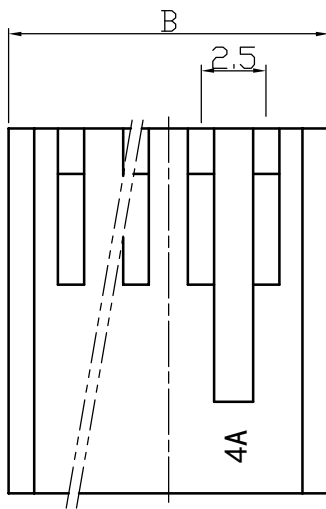

| Poles | Part No.   |        | Dimensions |      |
|-------|------------|--------|------------|------|
|       |            |        | A          | B    |
| 2     | WB2504-H02 | EI-2Y  | 2.5        | 6.9  |
| 3     | WB2504-H03 | EI-3Y  | 5          | 9.4  |
| 4     | WB2504-H04 | EI-4Y  | 7.5        | 11.9 |
| 5     | WB2504-H05 | EI-5Y  | 10         | 14.4 |
| 6     | WB2504-H06 | EI-6Y  | 12.5       | 16.9 |
| 7     | WB2504-H07 | EI-7Y  | 15         | 19.4 |
| 8     | WB2504-H08 | EI-8Y  | 17.5       | 21.9 |
| 9     | WB2504-H09 | EI-9Y  | 20         | 24.4 |
| 10    | WB2504-H10 | EI-10Y | 22.5       | 26.9 |
| 11    | WB2504-H11 | EI-11Y | 25         | 29.4 |
| -     | -          | -      | -          | -    |
| 24    | WB2504-H24 | EI-24Y | 57.5       | 61.9 |

|                      |                   |  |          |             |       |             |      |          |   |
|----------------------|-------------------|--|----------|-------------|-------|-------------|------|----------|---|
| 1                    | Housing           | PA66(UL94V-0/V-2)  | 1        | White       |       |             |      |          |   |
| No.                  | Item/Material No. | Material   | QTY      | Remark      |       |             |      |          |   |
| Unmarked Tolerance   |                   |  Yueqing Hegxing Electronics Co., Ltd |          |             |       |             |      |          |   |
| X. ° ±3° X. X° ±0.5° |                   |  |          |             |       |             |      |          |   |
| >0-3                 | >3-18             | >18-50   | >50-120  | Unit        | Scale | Design Unit | Size | Part No. |   |
| ±0.12                | ±0.15             | ±0.3   | ±0.5     | mm          | —     | Metric      | A4   |          |   |
| Draw                 | Review            | Approve  | Material | Drawing No. |       | Part No.    |      |          |   |
|                      |                   |  | Item     | EI-NY       |       |             |      |          |   |

EI Type Terminal

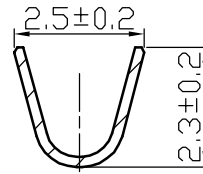
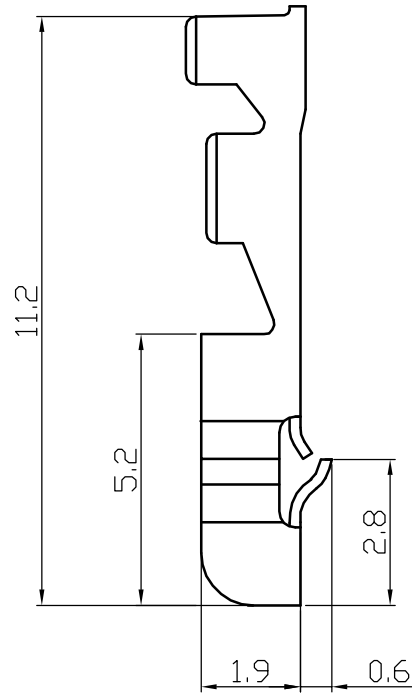
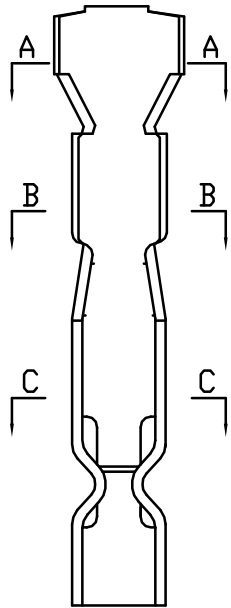

A-A

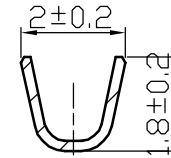

B-B

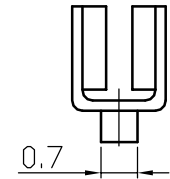

C-C

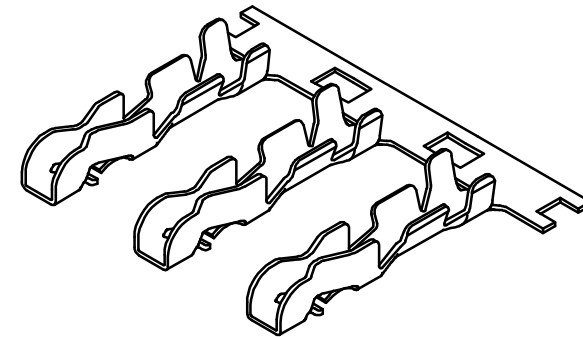

| 1                    | Terminal          | Phospher Bronze  | 1        |             |
|----------------------|-------------------|--|----------|-------------|
| No.                  | Item/Material No. | Material   | QTY      | Remark      |
| Unmarked Tolerance   |                   |  Yueqing Hegxing Electronics Co., Ltd |          |             |
| X. ° ±3° X. X° ±0.5° |                   |  |          |             |
| >0-3                 | >3-18             | >18-50   | >50-120  |             |
| ±0.12                | ±0.15             | ±0.3   | ±0.5     |             |
| Unit                 | Scale             | Design Unit  | Size     | Part No.    |
| mm                   | —                 | Metric   | A4       |             |
| Draw                 | Review            | Approve  | Material | Drawing No. |
|                      |                   |  | Item     | EI-T        |
|                      |                   |  |          | Part No.    |

EI Type Wafer

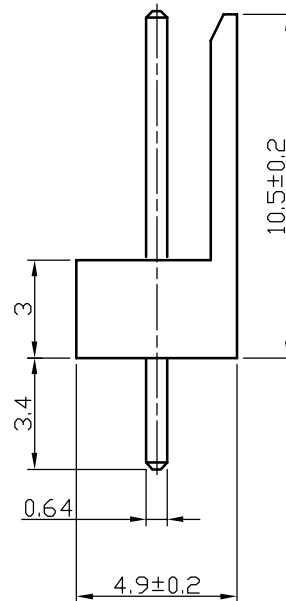
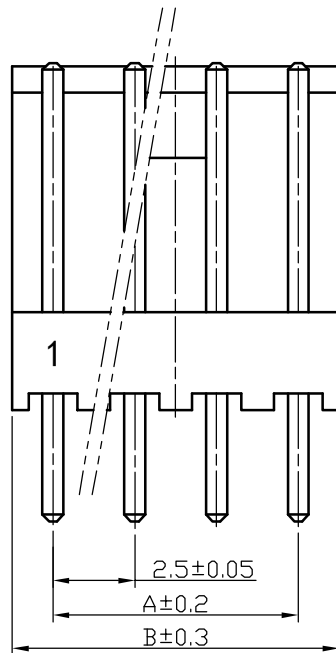

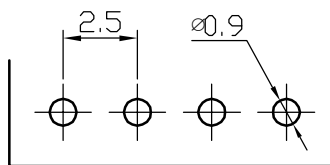

| Poles | Part No.    |        | Dimensions |      |
|-------|-------------|--------|------------|------|
|       |             |        | A          | B    |
| 2     | WB2504-PT02 | EI-2A  | 2.5        | 5    |
| 3     | WB2504-PT03 | EI-3A  | 5          | 7.5  |
| 4     | WB2504-PT04 | EI-4A  | 7.5        | 10   |
| 5     | WB2504-PT05 | EI-5A  | 10         | 12.5 |
| 6     | WB2504-PT06 | EI-6A  | 12.5       | 15   |
| 7     | WB2504-PT07 | EI-7A  | 15         | 17.5 |
| 8     | WB2504-PT08 | EI-8A  | 17.5       | 20   |
| 9     | WB2504-PT09 | EI-9A  | 20         | 22.5 |
| 10    | WB2504-PT10 | EI-10A | 22.5       | 25   |
| 11    | WB2504-PT11 | EI-11A | 25         | 27.5 |
| -     | -           | -      | -          | -    |
| 24    | WB2504-PT24 | EI-24A | 57.5       | 60   |

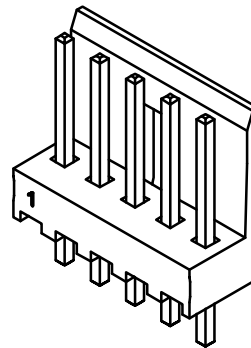

PCB Layout



|                      |                   |  |          |             |       |             |      |          |   |
|----------------------|-------------------|--|----------|-------------|-------|-------------|------|----------|---|
| 2                    | Pin               | Tin Plated Brass   | N        |             |       |             |      |          |   |
| 1                    | Housing           | PA9T (UL94V-0)   | 1        |             |       |             |      |          |   |
| No.                  | Item/Material No. | Material   | QTY      | Remark      |       |             |      |          |   |
| Unmarked Tolerance   |                   |  Yueqing Hegxing Electronics Co., Ltd |          |             |       |             |      |          |   |
| X. ° ±3° X. X° ±0.5° |                   |  |          |             |       |             |      |          |   |
| >0-3                 | >3-18             | >18-50   | >50-120  | Unit        | Scale | Design Unit | Size | Part No. |   |
| ±0.12                | ±0.15             | ±0.3   | ±0.5     | mm          | —     | Metric      | A4   |          |   |
| Draw                 | Review            | Approve  | Material | Drawing No. |       | Part No.    |      |          |   |
|                      |                   |  | Item     | EI-NA       |       |             |      |          |   |

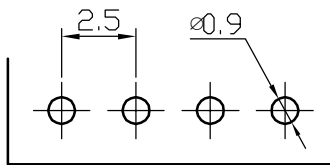
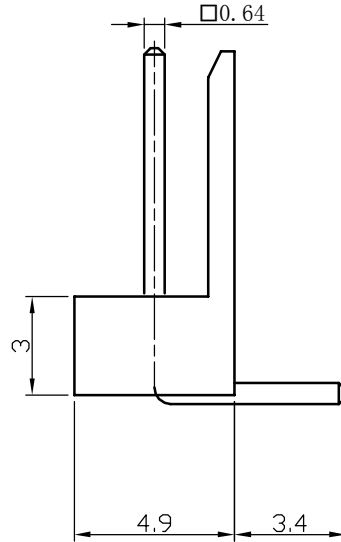
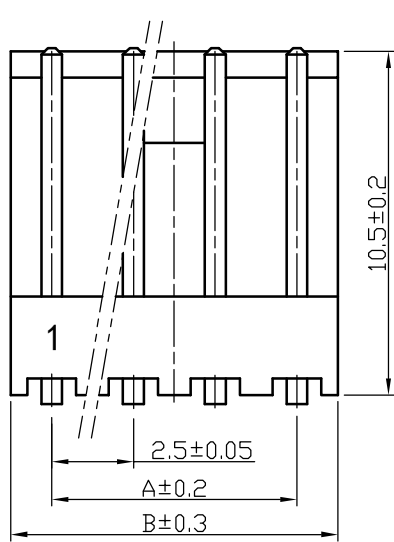

EI Type Wafer

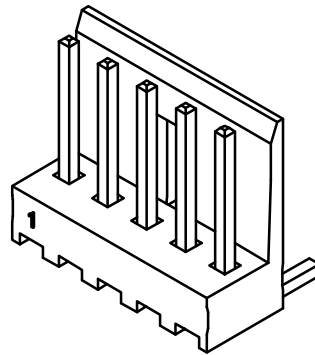

PCB Layout



| Poles | Part No.    |         | Dimensions |      |
|-------|-------------|---------|------------|------|
|       |             |         | A          | B    |
| 2     | WB2504-PS02 | EI-2AW  | 2.5        | 5    |
| 3     | WB2504-PS03 | EI-3AW  | 5          | 7.5  |
| 4     | WB2504-PS04 | EI-4AW  | 7.5        | 10   |
| 5     | WB2504-PS05 | EI-5AW  | 10         | 12.5 |
| 6     | WB2504-PS06 | EI-6AW  | 12.5       | 15   |
| 7     | WB2504-PS07 | EI-7AW  | 15         | 17.5 |
| 8     | WB2504-PS08 | EI-8AW  | 17.5       | 20   |
| 9     | WB2504-PS09 | EI-9AW  | 20         | 22.5 |
| 10    | WB2504-PS10 | EI-10AW | 22.5       | 25   |
| 11    | WB2504-PS11 | EI-11AW | 25         | 27.5 |
| -     | -           | -       | -          | -    |
| 24    | WB2504-PS24 | EI-24AW | 57.5       | 60   |

|                      |                   |  |          |             |        |             |          |          |   |
|----------------------|-------------------|--|----------|-------------|--------|-------------|----------|----------|---|
| 2                    | Pin               | Tin Plated Brass   | N        |             |        |             |          |          |   |
| 1                    | Housing           | PA9T (UL94V-0)   | 1        |             |        |             |          |          |   |
| No.                  | Item/Material No. | Material   | QTY      | Remark      |        |             |          |          |   |
| Unmarked Tolerance   |                   |  Yueqing Hegxing Electronics Co., Ltd |          |             |        |             |          |          |   |
| X. ° ±3° X. X° ±0.5° |                   |  |          |             |        |             |          |          |   |
| >0-3                 | >3-18             | >18-50   | >50-120  | Unit        | Scale  | Design Unit | Size     | Part No. |   |
| ±0.12                | ±0.15             | ±0.3   | ±0.5     | mm          | —      | Metric      | A4       |          |   |
| Draw                 | Review            | Approve  | Material | Drawing No. |        |             | Part No. |          |   |
|                      |                   |  |          | Item        | EI-NAW |             |          |          |   |

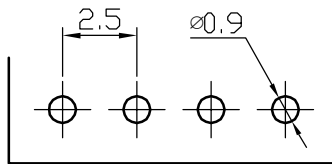
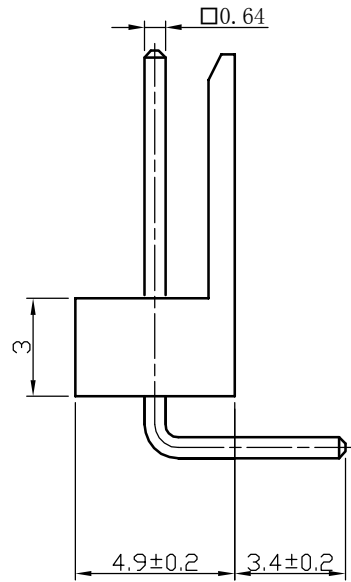
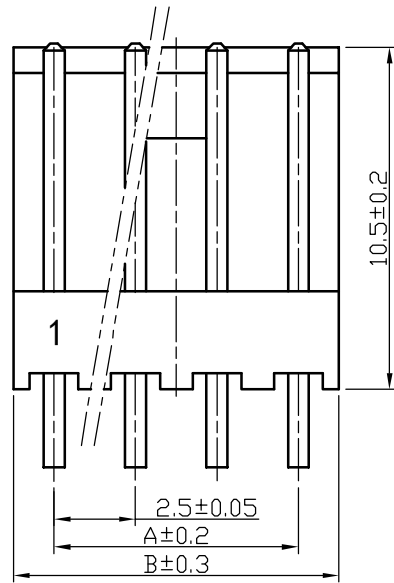

EI Type Wafer

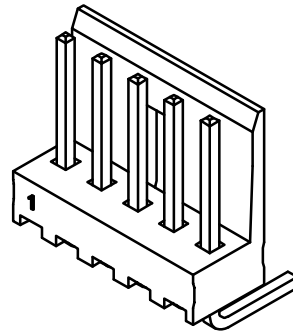

PCB Layout



| Poles | Part No.     |         | Dimensions |      |
|-------|--------------|---------|------------|------|
|       |              |         | A          | B    |
| 2     | WB2504-PSB02 | EI-2AW  | 2.5        | 5    |
| 3     | WB2504-PSB03 | EI-3AW  | 5          | 7.5  |
| 4     | WB2504-PSB04 | EI-4AW  | 7.5        | 10   |
| 5     | WB2504-PSB05 | EI-5AW  | 10         | 12.5 |
| 6     | WB2504-PSB06 | EI-6AW  | 12.5       | 15   |
| 7     | WB2504-PSB07 | EI-7AW  | 15         | 17.5 |
| 8     | WB2504-PSB08 | EI-8AW  | 17.5       | 20   |
| 9     | WB2504-PSB09 | EI-9AW  | 20         | 22.5 |
| 10    | WB2504-PSB10 | EI-10AW | 22.5       | 25   |
| 11    | WB2504-PSB11 | EI-11AW | 25         | 27.5 |
| -     | -            | -       | -          | -    |
| 24    | WB2504-PSB24 | EI-24AW | 57.5       | 60   |

|                      |                   |  |          |             |         |             |      |          |   |
|----------------------|-------------------|--|----------|-------------|---------|-------------|------|----------|---|
| 2                    | Pin               | Tin Plated Brass   | N        |             |         |             |      |          |   |
| 1                    | Housing           | PA9T (UL94V-0)   | 1        |             |         |             |      |          |   |
| No.                  | Item/Material No. | Material   | QTY      | Remark      |         |             |      |          |   |
| Unmarked Tolerance   |                   |  Yueqing Hegxing Electronics Co., Ltd |          |             |         |             |      |          |   |
| X. ° ±3° X. X° ±0.5° |                   |  |          |             |         |             |      |          |   |
| >0-3                 | >3-18             | >18-50   | >50-120  | Unit        | Scale   | Design Unit | Size | Part No. |   |
| ±0.12                | ±0.15             | ±0.3   | ±0.5     | mm          | —       | Metric      | A4   |          |   |
| Draw                 | Review            | Approve  | Material | Drawing No. |         | Part No.    |      |          |   |
|                      |                   |  |          | Item        | EI-NAWG |             |      |          |   |