

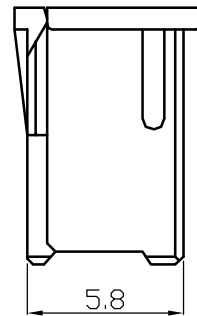

XA Type Housing

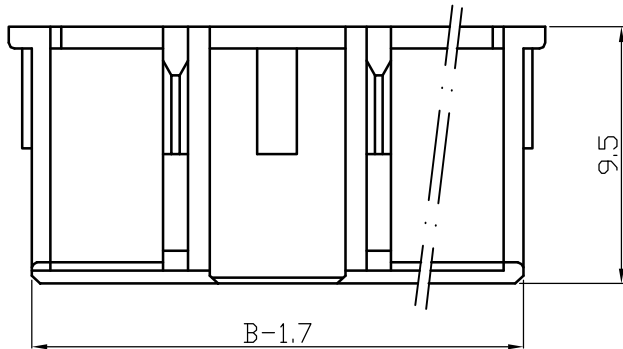
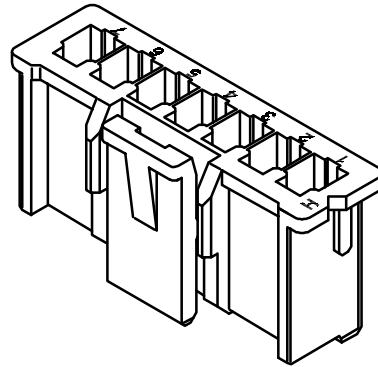
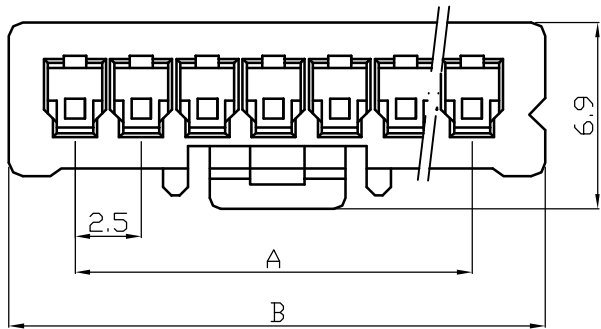

Poles	Part No.		Dimensions	
			A	B
2	WB2506-H02	XA-2Y	2.5	7.3
3	WB2506-H03	XA-3Y	5	9.8
4	WB2506-H04	XA-4Y	7.5	12.3
5	WB2506-H05	XA-5Y	10	14.8
6	WB2506-H06	XA-6Y	12.5	17.3
7	WB2506-H07	XA-7Y	15	19.8
8	WB2506-H08	XA-8Y	17.5	22.3
9	WB2506-H09	XA-9Y	20	24.8
10	WB2506-H10	XA-10Y	22.5	27.3
11	WB2506-H11	XA-11Y	25	29.8
-	-	-	-	-
20	WB2506-H20	XA-20Y	47.5	52.3

1	Housing	PA66(UL94V-0/V-2)	1	White					
No.	Item/Material No.	Material	QTY	Remark					
Unmarked Tolerance		 Yueqing Hegxing Electronics Co., Ltd							
X. ° ±3° X. X° ±0.5°									
>0-3	>3-18	>18-50	>50-120	Unit	Scale	Design Unit	Size	Part No.	 
±0.12	±0.15	±0.3	±0.5	mm	—	Metric	A4		
Draw	Review	Approve	Material	Drawing No.		Part No.			
				Item	XA-NY				

XA Type Terminal

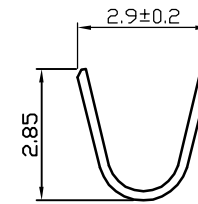
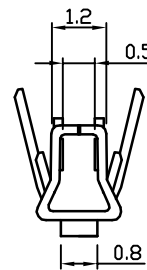
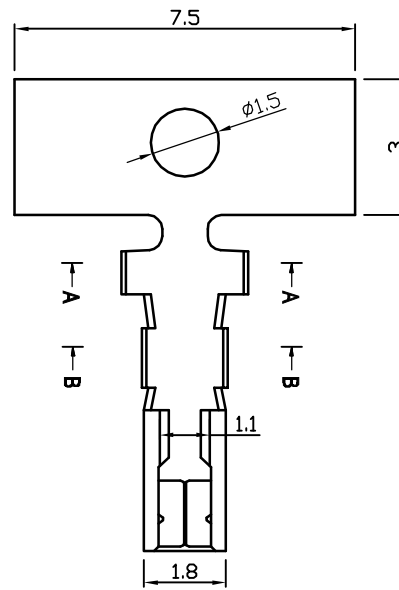
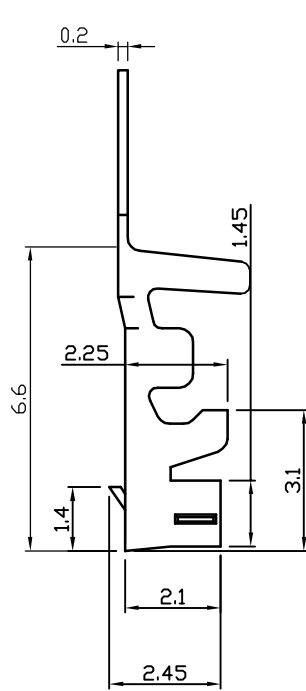

A-A

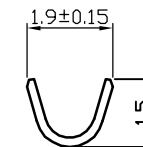

B-B

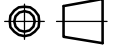
1	Terminal	Phosphor Bronze	1						
No.	Item/Material No.	Material	QTY	Remark					
Unmarked Tolerance		 Yueqing Hegxing Electronics Co., Ltd							
X. ° ±3°	X. X° ±0.5°								
>0-3	>3-18	>18-50	>50-120	Unit	Scale	Design Unit	Size	Part No.	
±0.12	±0.15	±0.3	±0.5	mm	—	Metric	A4		
Draw	Review	Approve	Material	Drawing No.			Part No.		
				Item	XA-T				

XA Type Wafer

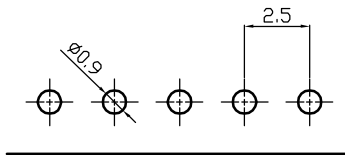
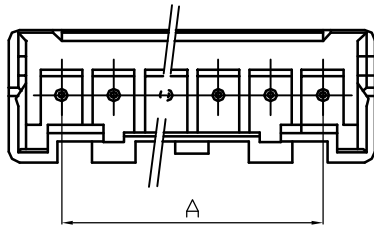
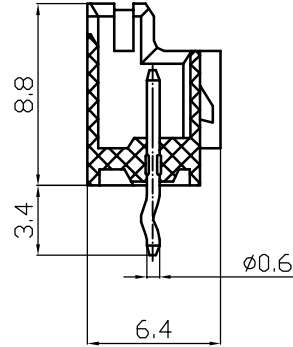
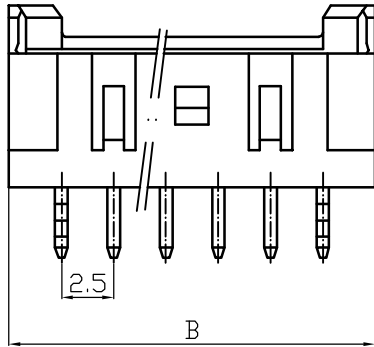

PCB Layout

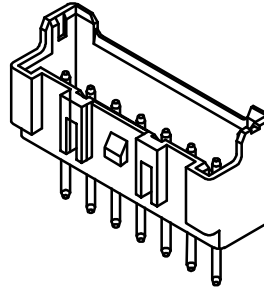

Poles	Part No.		Dimensions	
			A	B
2	WB2506-PT02	XA-2A	2.5	7.5
3	WB2506-PT03	XA-3A	5	10
4	WB2506-PT04	XA-4A	7.5	12.5
5	WB2506-PT05	XA-5A	10	15
6	WB2506-PT06	XA-6A	12.5	17.5
7	WB2506-PT07	XA-7A	15	20
8	WB2506-PT08	XA-8A	17.5	22.5
9	WB2506-PT09	XA-9A	20	25
10	WB2506-PT10	XA-10A	22.5	27.5
11	WB2506-PT11	XA-11A	25	30
-	-	-	-	-
20	WB2506-PT20	XA-20A	47.5	52.5

2	Pin	Tin Plated Brass	N						
1	Housing	PA9T (UL94V-0)	1						
No.	Item/Material No.	Material	QTY	Remark					
Unmarked Tolerance		Yueqing Hegxing Electronics Co., Ltd							
X. ° ±3° X. X° ±0.5°									
>0-3	>3-18	>18-50	>50-120	Unit	Scale	Design Unit	Size	Part No.	
±0.12	±0.15	±0.3	±0.5	mm	—	Metric	A4		
Draw	Review	Approve	Material	Drawing No.	Part No.				
				Item	XA-NA-107				