

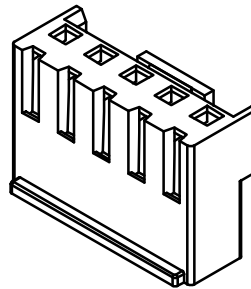

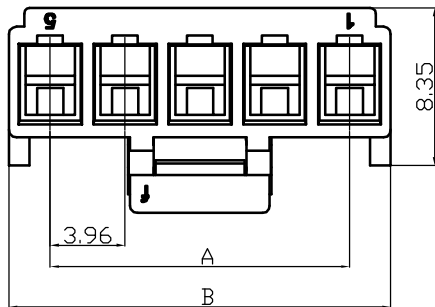

VH Type Housing

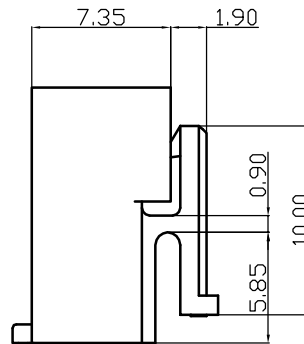

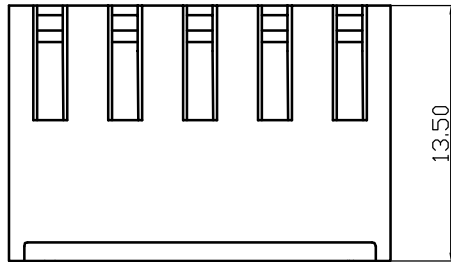

| Poles | Part No. | | Dimensions | |
|-------|------------|--------|------------|-------|
| | | | A | B |
| 2 | WB3963-H02 | VH-2Y | 3.96 | 8.52 |
| 3 | WB3963-H03 | VH-3Y | 7.92 | 12.48 |
| 4 | WB3963-H04 | VH-4Y | 11.88 | 16.44 |
| 5 | WB3963-H05 | VH-5Y | 15.84 | 20.4 |
| 6 | WB3963-H06 | VH-6Y | 19.8 | 24.36 |
| 7 | WB3963-H07 | VH-7Y | 23.76 | 28.32 |
| 8 | WB3963-H08 | VH-8Y | 27.72 | 32.28 |
| 9 | WB3963-H09 | VH-9Y | 31.68 | 36.24 |
| 10 | WB3963-H10 | VH-10Y | 35.64 | 40.2 |
| 11 | WB3963-H11 | VH-11Y | 39.6 | 44.16 |
| - | - | - | - | - |
| 16 | WB3963-H16 | VH-16Y | 59.4 | 63.96 |

| | | | | | | | | | |
|--------------------|-------------------|--|----------|-------------|-------|-------------|----------|----------|---|
| 1 | Housing | PA66(UL94V-0/V-2) | 1 | White | | | | | |
| No. | Item/Material No. | Material | QTY | Remark | | | | | |
| Unmarked Tolerance | |  Yueqing Hegxing Electronics Co., Ltd | | | | | | | |
| X. ° ±3° | X. X° ±0.5° | | | | | | | | |
| >0-3 | >3-18 | >18-50 | >50-120 | Unit | Scale | Design Unit | Size | Part No. |   |
| ±0.12 | ±0.15 | ±0.3 | ±0.5 | mm | — | Metric | A4 | | |
| Draw | Review | Approve | Material | Drawing No. | | | Part No. | | |
| | | | | Item | VH-NY | | | | |

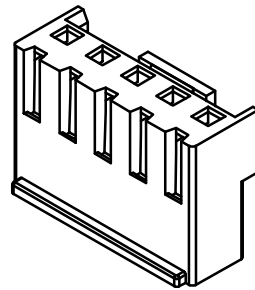
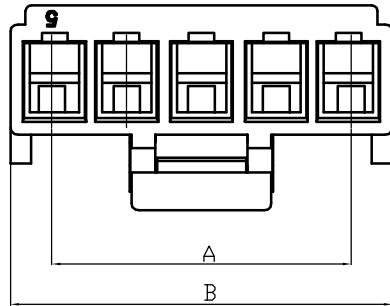
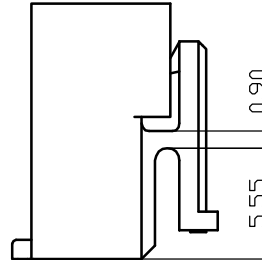
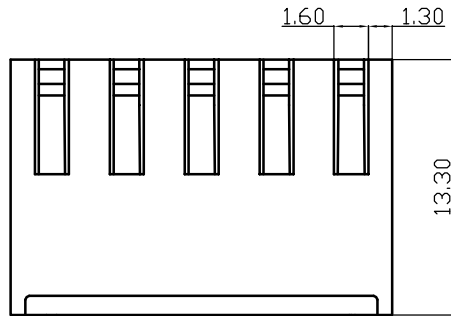
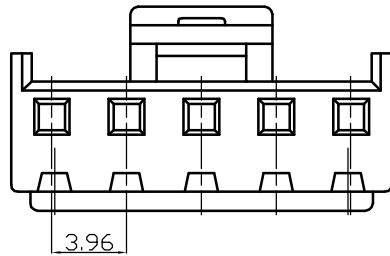
VH Type Housing





| Poles | Part No. | | Dimensions | |
|-------|-------------|---------|------------|-------|
| | | | A | B |
| 2 | WB3963-HB02 | VHB-2Y | 3.96 | 7.86 |
| 3 | WB3963-HB03 | VHB-3Y | 7.92 | 11.82 |
| 4 | WB3963-HB04 | VHB-4Y | 11.88 | 15.78 |
| 5 | WB3963-HB05 | VHB-5Y | 15.84 | 19.74 |
| 6 | WB3963-HB06 | VHB-6Y | 19.8 | 23.7 |
| 7 | WB3963-HB07 | VHB-7Y | 23.76 | 27.66 |
| 8 | WB3963-HB08 | VHB-8Y | 27.72 | 31.62 |
| 9 | WB3963-HB09 | VHB-9Y | 31.68 | 35.58 |
| 10 | WB3963-HB10 | VHB-10Y | 35.64 | 39.54 |
| 11 | WB3963-HB11 | VHB-11Y | 39.6 | 43.5 |
| - | - | - | - | - |
| 16 | WB3963-HB16 | VHB-16Y | 59.4 | 63.3 |

| 1 | Housing | PA66(UL94V-0/V-2) | 1 | White | | | | | |
|----------------------|-------------------|--|----------|-------------|--------|-------------|----------|----------|---|
| No. | Item/Material No. | Material | QTY | Remark | | | | | |
| Unmarked Tolerance | |  Yueqing Hegxing Electronics Co., Ltd | | | | | | | |
| X. ° ±3° X. X° ±0.5° | | | | | | | | | |
| >0-3 | >3-18 | >18-50 | >50-120 | Unit | Scale | Design Unit | Size | Part No. |   |
| ±0.12 | ±0.15 | ±0.3 | ±0.5 | mm | — | Metric | A4 | | |
| Draw | Review | Approve | Material | Drawing No. | | | Part No. | | |
| | | | | Item | VHB-NY | | | | |

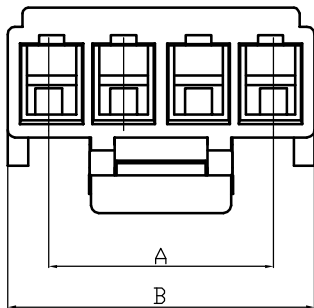
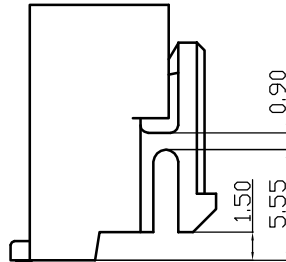
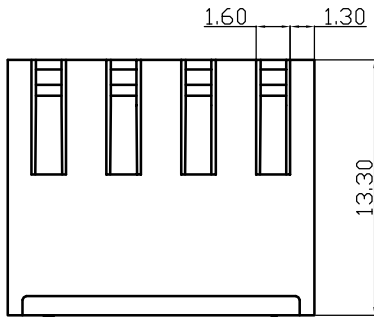
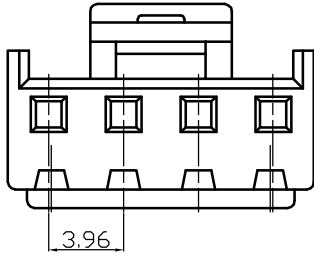
VH Type Housing





| Poles | Part No. | | Dimensions | |
|-------|-------------|--------|------------|-------|
| | | | A | B |
| 2 | WB3963-HC02 | VHC-2Y | 3.96 | 7.86 |
| 3 | WB3963-HC03 | VHC-3Y | 7.92 | 11.82 |
| 4 | WB3963-HC04 | VHC-4Y | 11.88 | 15.78 |

| 1 | Housing | PA66(UL94V-0/V-2) | 1 | White | | | | | |
|----------------------|-------------------|--|----------|-------------|----------|-------------|------|----------|---|
| No. | Item/Material No. | Material | QTY | Remark | | | | | |
| Unmarked Tolerance | |  Yueqing Hegxing Electronics Co., Ltd | | | | | | | |
| X. ° ±3° X. X° ±0.5° | | | | | | | | | |
| >0-3 | >3-18 | >18-50 | >50-120 | Unit | Scale | Design Unit | Size | Part No. |   |
| ±0.12 | ±0.15 | ±0.3 | ±0.5 | mm | — | Metric | A4 | | |
| Draw | Review | Approve | Material | Drawing No. | Part No. | | | | |
| | | | | Item | VHC-2~4Y | | | | |

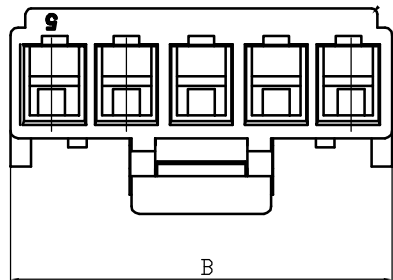
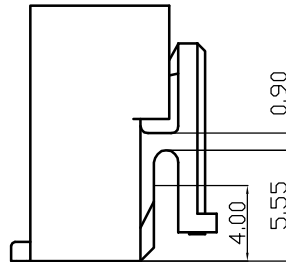
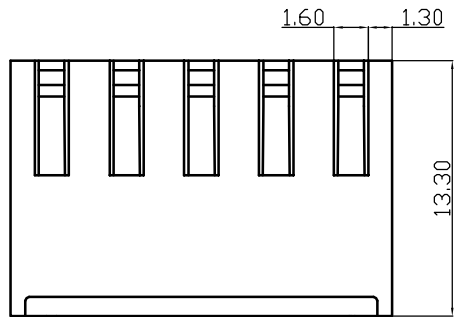
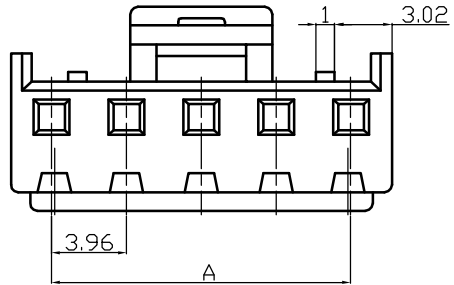
VH Type Housing





| Poles | Part No. | | Dimensions | |
|-------|-------------|---------|------------|-------|
| | | | A | B |
| 5 | WB3963-HC05 | VHC-5Y | 15.84 | 19.74 |
| 6 | WB3963-HC06 | VHC-6Y | 19.8 | 23.7 |
| 7 | WB3963-HC07 | VHC-7Y | 23.76 | 27.66 |
| 8 | WB3963-HC08 | VHC-8Y | 27.72 | 31.62 |
| 9 | WB3963-HC09 | VHC-9Y | 31.68 | 35.58 |
| 10 | WB3963-HC10 | VHC-10Y | 35.64 | 39.54 |
| 11 | WB3963-HC11 | VHC-11Y | 39.6 | 43.5 |
| 12 | WB3963-HC12 | VHC-12Y | 43.56 | 47.46 |
| 13 | WB3963-HC13 | VHC-13Y | 47.52 | 51.42 |
| 14 | WB3963-HC14 | VHC-14Y | 51.48 | 55.38 |
| 15 | WB3963-HC15 | VHC-15Y | 55.44 | 59.34 |
| 16 | WB3963-HC16 | VHC-16Y | 59.4 | 63.3 |

| | | | | | | | | | |
|----------------------|-------------------|--|----------|-------------|-----------|-------------|------|----------|---|
| 1 | Housing | PA66(UL94V-0/V-2) | 1 | White | | | | | |
| No. | Item/Material No. | Material | QTY | Remark | | | | | |
| Unmarked Tolerance | |  Yueqing Hegxing Electronics Co., Ltd | | | | | | | |
| X. ° ±3° X. X° ±0.5° | | | | | | | | | |
| >0-3 | >3-18 | >18-50 | >50-120 | Unit | Scale | Design Unit | Size | Part No. |  |
| ±0.12 | ±0.15 | ±0.3 | ±0.5 | mm | — | Metric | A4 | | |
| Draw | Review | Approve | Material | Drawing No. | Part No. | | | | |
| | | | | Item | VHC-5~16Y | | | | |

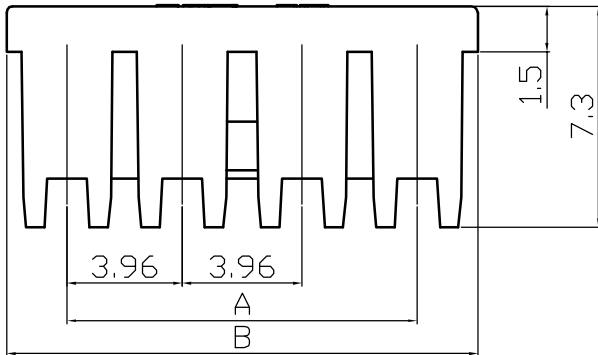
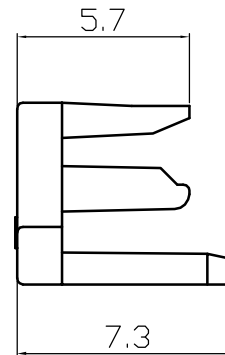
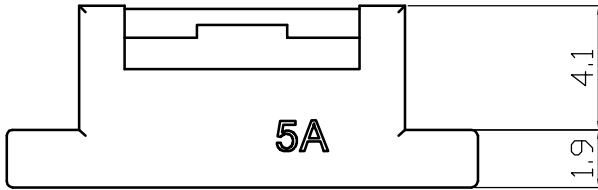
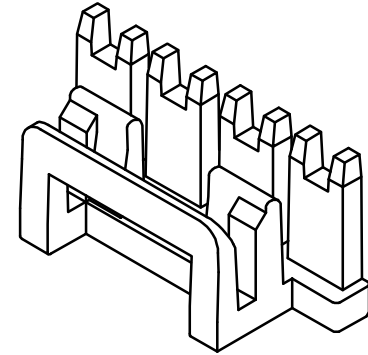
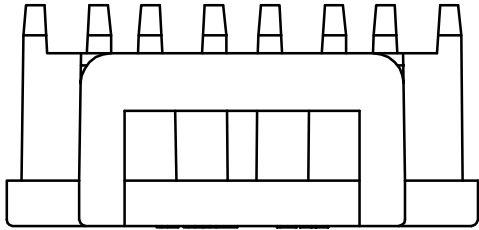
VH Type Retainer



| Poles | Part No. | | Dimensions | |
|-------|------------|----------|------------|-------|
| | | | A | B |
| 2 | WB3963-F02 | VHC-2RST | 3.66 | 7.66 |
| 3 | WB3963-F03 | VHC-3RST | 7.62 | 11.62 |
| 4 | WB3963-F04 | VHC-4RST | 11.58 | 15.58 |

| | | | | | | | | | |
|----------------------|-------------------|--|----------|-------------|------------|-------------|------|----------|---|
| 1 | Retainer | PA66(UL94V-0/V-2) | 1 | White | | | | | |
| No. | Item/Material No. | Material | QTY | Remark | | | | | |
| Unmarked Tolerance | |  Yueqing Hegxing Electronics Co., Ltd | | | | | | | |
| X. ° ±3° X. X° ±0.5° | | | | | | | | | |
| >0-3 | >3-18 | >18-50 | >50-120 | Unit | Scale | Design Unit | Size | Part No. |   |
| ±0.12 | ±0.15 | ±0.3 | ±0.5 | mm | — | Metric | A4 | | |
| Draw | Review | Approve | Material | Drawing No. | Part No. | | | | |
| | | | | Item | VHC-2~4RST | | | | |

VH Type Retainer

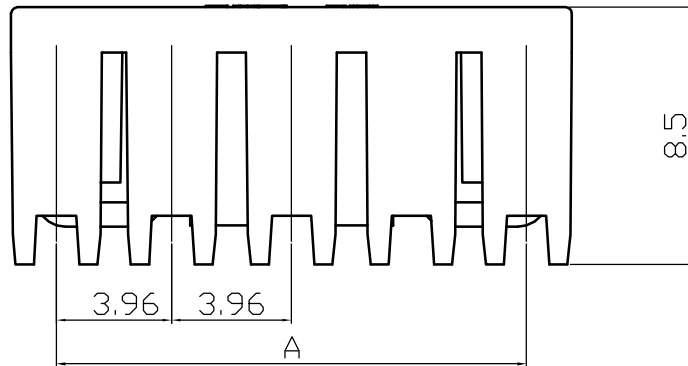
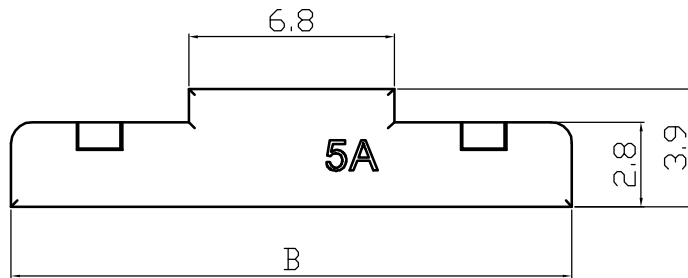
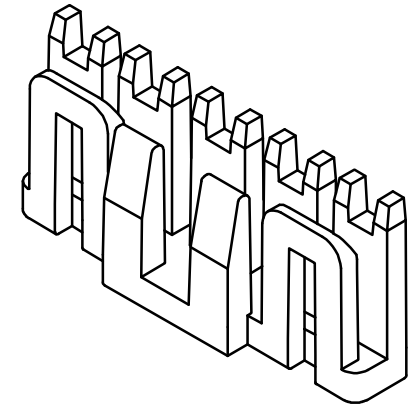
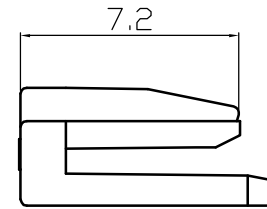
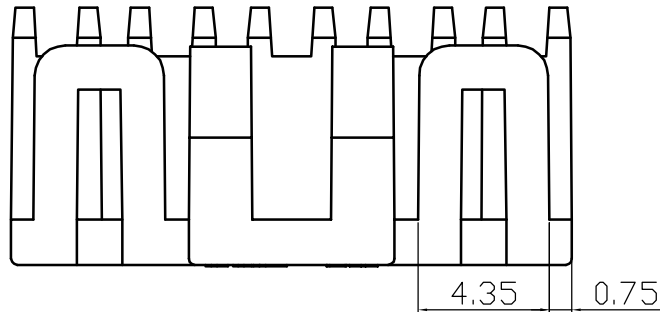

| Poles | Part No. | | Dimensions | |
|-------|------------|-----------|------------|-------|
| | | | A | B |
| 5 | WB3963-F05 | VHC-5RST | 15.54 | 18.54 |
| 6 | WB3963-F06 | VHC-6RST | 19.5 | 22.5 |
| 7 | WB3963-F07 | VHC-7RST | 23.46 | 26.46 |
| 8 | WB3963-F08 | VHC-8RST | 27.42 | 30.42 |
| 9 | WB3963-F09 | VHC-9RST | 31.38 | 34.38 |
| 10 | WB3963-F10 | VHC-10RST | 35.34 | 38.34 |
| 11 | WB3963-F11 | VHC-11RST | 39.3 | 42.3 |
| 12 | WB3963-F12 | VHC-12RST | 43.26 | 46.26 |
| 13 | WB3963-F13 | VHC-13RST | 47.22 | 50.22 |
| 14 | WB3963-F14 | VHC-14RST | 51.18 | 54.18 |
| 15 | WB3963-F15 | VHC-15RST | 55.14 | 58.14 |
| 16 | WB3963-F16 | VHC-16RST | 59.1 | 62.1 |

| | | | | | | | | | |
|----------------------|-------------------|--------------------------------------|----------|-------------|-------------|-------------|------|----------|--|
| 1 | Retainer | PA66(UL94V-0/V-2) | 1 | White | | | | | |
| No. | Item/Material No. | Material | QTY | Remark | | | | | |
| Unmarked Tolerance | | Yueqing Hegxing Electronics Co., Ltd | | | | | | | |
| X. ° ±3° X. X° ±0.5° | | | | | | | | | |
| >0-3 | >3-18 | >18-50 | >50-120 | Unit | Scale | Design Unit | Size | Part No. | |
| ±0.12 | ±0.15 | ±0.3 | ±0.5 | mm | — | Metric | A4 | | |
| Draw | Review | Approve | Material | Drawing No. | Part No. | | | | |
| | | | | Item | VHC-5~16RST | | | | |

VH Type Retainer

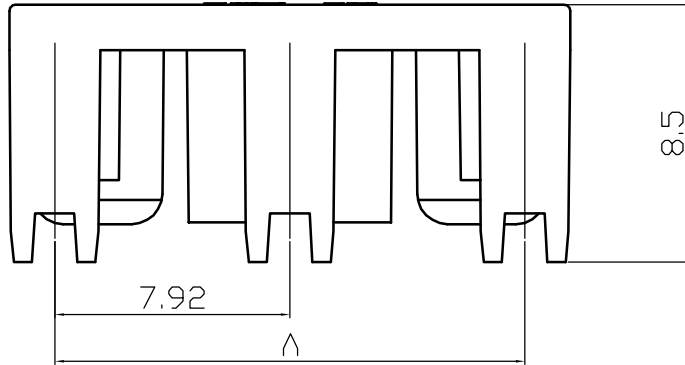
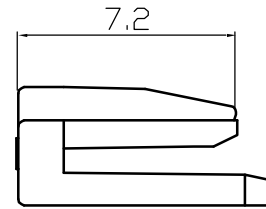
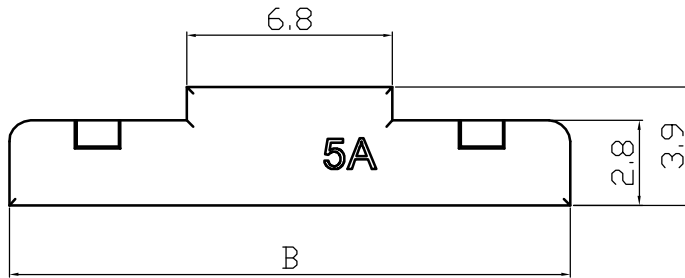
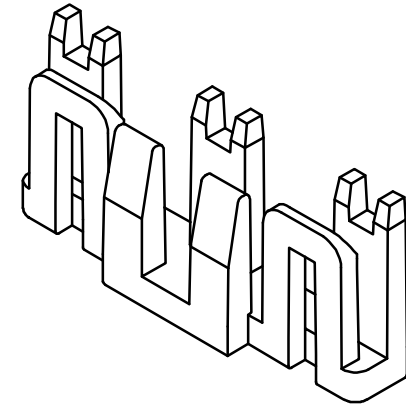
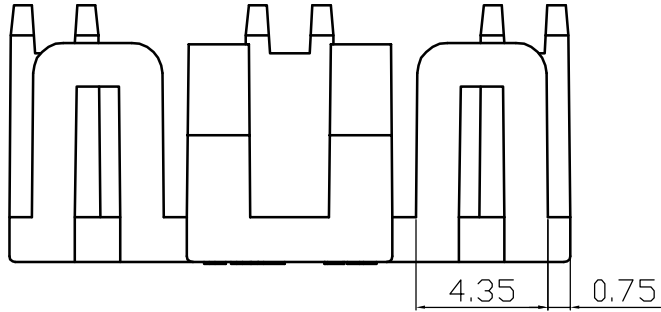

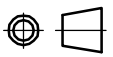

| Poles | Part No. | | Dimensions | |
|-------|-------------|-----------|------------|-------|
| | A | B | A | B |
| 5 | WB3963-FB05 | VHC-5RSTB | 15.54 | 18.54 |

| 1 | Retainer | PA66(UL94V-0/V-2) | 1 | White |
|----------------------|-------------------|--|---------|----------|
| No. | Item/Material No. | Material | QTY | Remark |
| Unmarked Tolerance | |  Yueqing Hegxing Electronics Co., Ltd | | |
| X. ° ±3° X. X° ±0.5° | | | | |
| >0-3 | >3-18 | >18-50 | >50-120 | Unit |
| ±0.12 | ±0.15 | ±0.3 | ±0.5 | Scale |
| Draw | | Review | Approve | Material |
| Item | | VHC-RST | | |

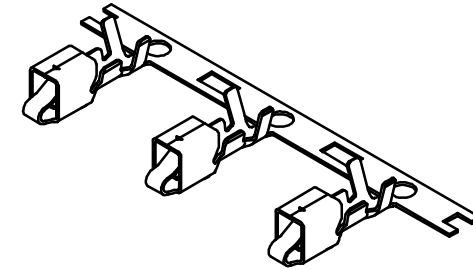
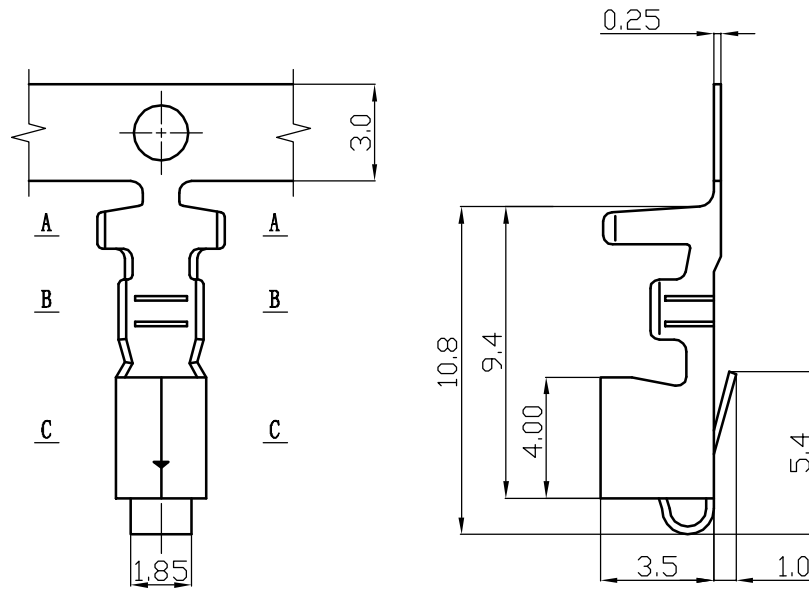

VH Type Terminal



| 1 | Terminal | Phosphor Bronze | 1 | |
|----------------------|-------------------|--|----------|----------|
| No. | Item/Material No. | Material | QTY | Remark |
| Unmarked Tolerance | |  Yueqing Hegxing Electronics Co., Ltd | | |
| X. ° ±3° X. X° ±0.5° | | | | |
| >0-3 | >3-18 | >18-50 | >50-120 | |
| ±0.12 | ±0.15 | ±0.3 | ±0.5 | |
| Unit | Scale | Design Unit | Size | Part No. |
| mm | — | Metric | A4 | |
| Draw | Review | Approve | Material | Part No. |
| | | | Item | VH-T11 |

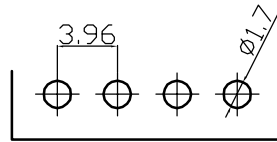
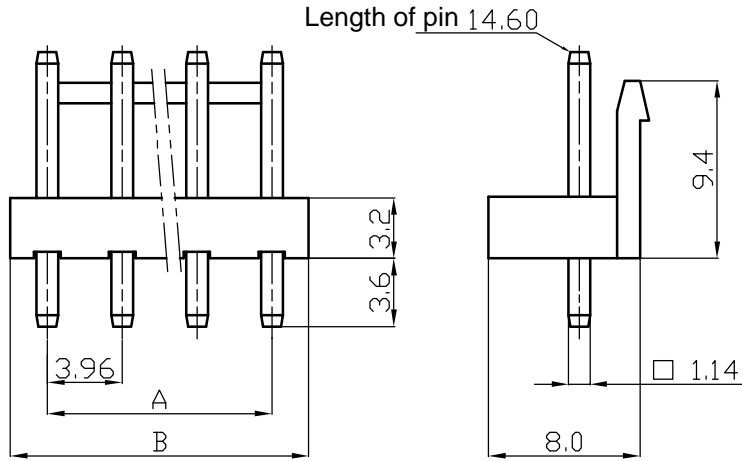

VH Type Wafer

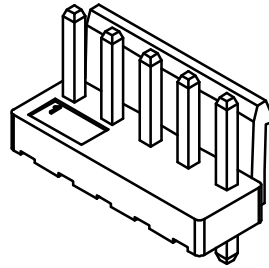

PCB Layout



| Poles | Part No. | | Dimensions | |
|-------|-------------|--------|------------|-------|
| | | | A | B |
| 2 | WB3963-PT02 | VH-2A | 3.96 | 7.92 |
| 3 | WB3963-PT03 | VH-3A | 7.92 | 11.88 |
| 4 | WB3963-PT04 | VH-4A | 11.88 | 15.84 |
| 5 | WB3963-PT05 | VH-5A | 15.84 | 19.8 |
| 6 | WB3963-PT06 | VH-6A | 19.8 | 23.76 |
| 7 | WB3963-PT07 | VH-7A | 23.76 | 27.72 |
| 8 | WB3963-PT08 | VH-8A | 27.72 | 31.68 |
| 9 | WB3963-PT09 | VH-9A | 31.68 | 35.64 |
| 10 | WB3963-PT10 | VH-10A | 35.64 | 39.6 |
| 11 | WB3963-PT11 | VH-11A | 39.6 | 43.56 |
| - | - | - | - | - |
| 16 | WB3963-PT16 | VH-16A | 59.4 | 63.36 |

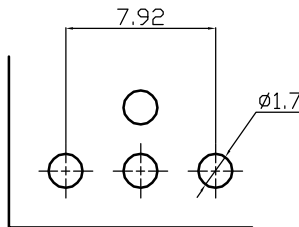
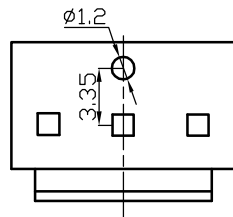
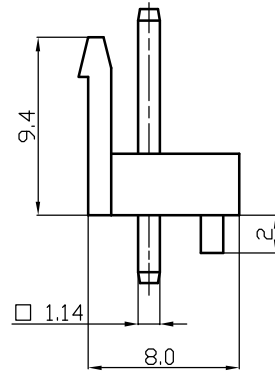
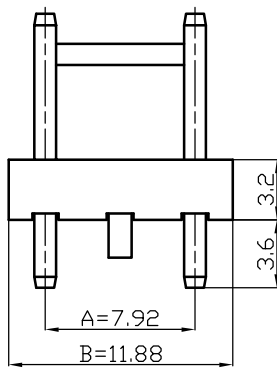

| | | | | | | | | | |
|----------------------|-------------------|--|----------|-------------|-------|-------------|------|----------|---|
| 2 | Pin | Tin Plated Brass | N | | | | | | |
| 1 | Housing | PA9T (UL94V-0) | 1 | | | | | | |
| No. | Item/Material No. | Material | QTY | Remark | | | | | |
| Unmarked Tolerance | |  Yueqing Hegxing Electronics Co., Ltd | | | | | | | |
| X. ° ±3° X. X° ±0.5° | | | | | | | | | |
| >0-3 | >3-18 | >18-50 | >50-120 | Unit | Scale | Design Unit | Size | Part No. |   |
| ±0.12 | ±0.15 | ±0.3 | ±0.5 | mm | — | Metric | A4 | | |
| Draw | Review | Approve | Material | Drawing No. | | Part No. | | | |
| | | | Item | VH-NA | | | | | |

VH Type Wafer



PCB Layout

| Poles | Part No. | | Dimensions | |
|-------|---------------|------------------|------------|-------|
| | | | A | B |
| 3 | WB3963-PSDB03 | VH-3ADB2 Pin (2) | 7.92 | 11.88 |

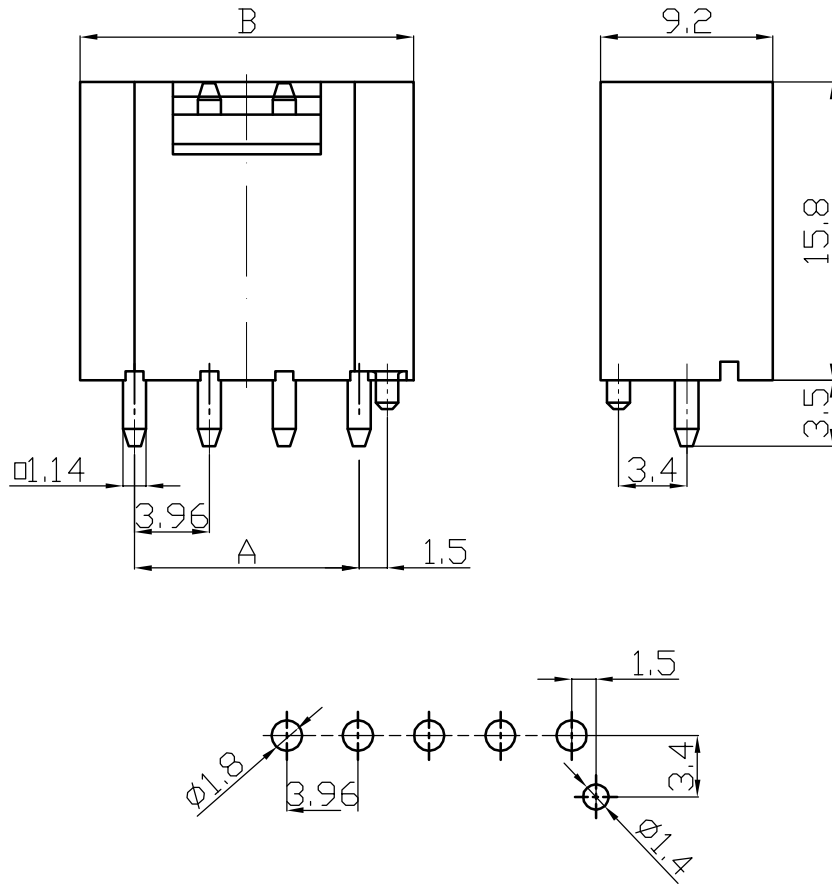

| 2 | Pin | Tin Plated Brass | N | | | | | | |
|----------------------|-------------------|--|----------|------------------|----------|-------------|------|----------|---|
| 1 | Housing | PA9T (UL94V-0) | 1 | | | | | | |
| No. | Item/Material No. | Material | QTY | Remark | | | | | |
| Unmarked Tolerance | |  Yueqing Hegxing Electronics Co., Ltd | | | | | | | |
| X. ° ±3° X. X° ±0.5° | | | | | | | | | |
| >0-3 | >3-18 | >18-50 | >50-120 | Unit | Scale | Design Unit | Size | Part No. |   |
| ±0.12 | ±0.15 | ±0.3 | ±0.5 | mm | — | Metric | A4 | | |
| Draw | Review | Approve | Material | Drawing No. | Part No. | | | | |
| | | | Item | VH-3ADB2 Pin (2) | | | | | |

VH Type Wafer



| Poles | Part No. | | Dimensions | |
|-------|--------------|---------|------------|-------|
| | | | A | B |
| 2 | WB3963-PTC02 | VH-2BH | 3.96 | 7.92 |
| 3 | WB3963-PTC03 | VH-3BH | 7.92 | 11.88 |
| 4 | WB3963-PTC04 | VH-4BH | 11.88 | 15.84 |
| 5 | WB3963-PTC05 | VH-5BH | 15.84 | 19.8 |
| 6 | WB3963-PTC06 | VH-6BH | 19.8 | 23.76 |
| 7 | WB3963-PTC07 | VH-7BH | 23.76 | 27.72 |
| 8 | WB3963-PTC08 | VH-8BH | 27.72 | 31.68 |
| 9 | WB3963-PTC09 | VH-9BH | 31.68 | 35.64 |
| 10 | WB3963-PTC10 | VH-10BH | 35.64 | 39.6 |
| 11 | WB3963-PTC11 | VH-11BH | 39.6 | 43.56 |
| 12 | WB3963-PTC12 | VH-12BH | 39.6 | 43.56 |

PCB Layout

| | | | | | | | | | |
|----------------------|-------------------|--|----------|-------------|-----------|-------------|------|----------|---|
| 2 | Pin | Tin Plated Brass | N | | | | | | |
| 1 | Housing | PA9T (UL94V-0) | 1 | | | | | | |
| No. | Item/Material No. | Material | QTY | Remark | | | | | |
| Unmarked Tolerance | |  Yueqing Hegxing Electronics Co., Ltd | | | | | | | |
| X. ° ±3° X. X° ±0.5° | | | | | | | | | |
| >0-3 | >3-18 | >18-50 | >50-120 | Unit | Scale | Design Unit | Size | Part No. |   |
| ±0.12 | ±0.15 | ±0.3 | ±0.5 | mm | — | Metric | A4 | | |
| Draw | Review | Approve | Material | Drawing No. | Part No. | | | | |
| | | | | Item | VH-NBH-96 | | | | |

VH Type Wafer

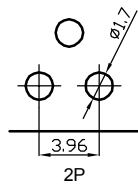
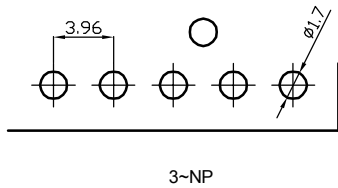
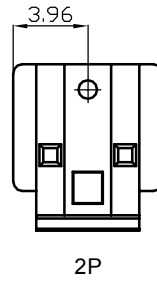
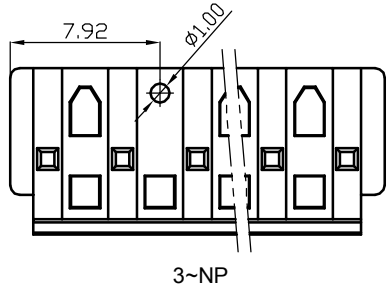
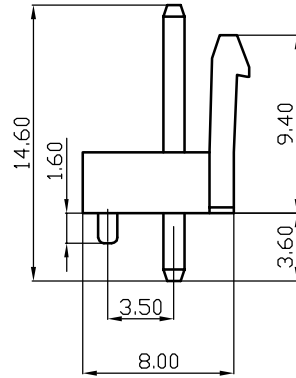
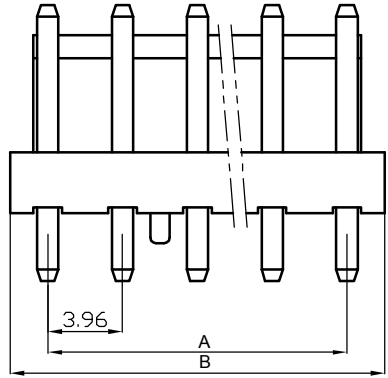

PCB Layout

| Poles | Part No. | | Dimensions | |
|-------|--------------|---------|------------|-------|
| | | | A | B |
| 2 | WB3963-PTD02 | VH-2AD | 3.96 | 7.92 |
| 3 | WB3963-PTD03 | VH-3AD | 7.92 | 11.88 |
| 4 | WB3963-PTD04 | VH-4AD | 11.88 | 15.84 |
| 5 | WB3963-PTD05 | VH-5AD | 15.84 | 19.8 |
| 6 | WB3963-PTD06 | VH-6AD | 19.8 | 23.76 |
| 7 | WB3963-PTD07 | VH-7AD | 23.76 | 27.72 |
| 8 | WB3963-PTD08 | VH-8AD | 27.72 | 31.68 |
| 9 | WB3963-PTD09 | VH-9AD | 31.68 | 35.64 |
| 10 | WB3963-PTD10 | VH-10AD | 35.64 | 39.6 |
| 11 | WB3963-PTD11 | VH-11AD | 39.6 | 43.56 |
| - | - | - | - | - |
| 16 | WB3963-PTD16 | VH-16AD | 59.4 | 63.36 |

| | | | | | | | | | |
|----------------------|-------------------|--------------------------------------|----------|-------------|--------|-------------|------|----------|--|
| 2 | Pin | Tin Plated Brass | N | | | | | | |
| 1 | Housing | PA9T (UL94V-0) | 1 | | | | | | |
| No. | Item/Material No. | Material | QTY | Remark | | | | | |
| Unmarked Tolerance | | Yueqing Hegxing Electronics Co., Ltd | | | | | | | |
| X. ° ±3° X. X° ±0.5° | | | | | | | | | |
| >0-3 | >3-18 | >18-50 | >50-120 | Unit | Scale | Design Unit | Size | Part No. | |
| ±0.12 | ±0.15 | ±0.3 | ±0.5 | mm | — | Metric | A4 | | |
| Draw | Review | Approve | Material | Drawing No. | | Part No. | | | |
| | | | | Item | VH-NAD | | | | |

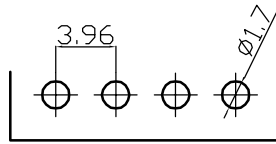
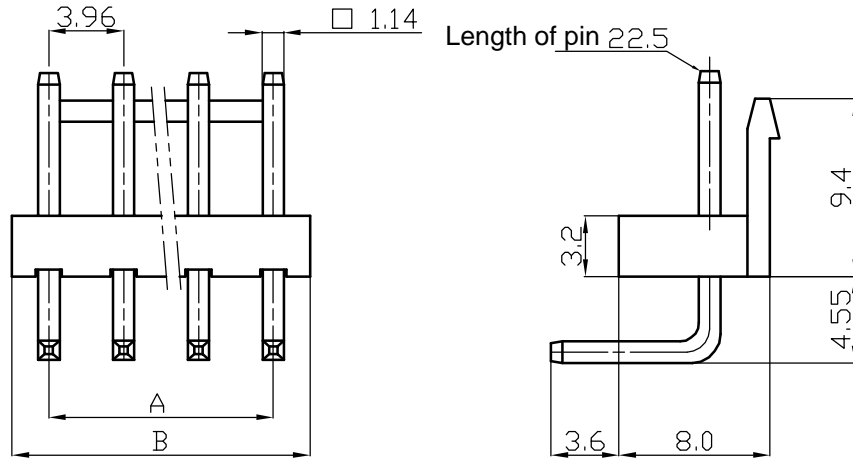

VH Type Wafer

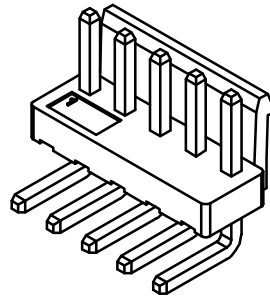

PCB Layout



| Poles | Part No. | | Dimensions | |
|-------|-------------|----------|------------|-------|
| | | | A | B |
| 2 | WB3963-PS02 | VH-2AWG | 3.96 | 7.92 |
| 3 | WB3963-PS03 | VH-3AWG | 7.92 | 11.88 |
| 4 | WB3963-PS04 | VH-4AWG | 11.88 | 15.84 |
| 5 | WB3963-PS05 | VH-5AWG | 15.84 | 19.8 |
| 6 | WB3963-PS06 | VH-6AWG | 19.8 | 23.76 |
| 7 | WB3963-PS07 | VH-7AWG | 23.76 | 27.72 |
| 8 | WB3963-PS08 | VH-8AWG | 27.72 | 31.68 |
| 9 | WB3963-PS09 | VH-9AWG | 31.68 | 35.64 |
| 10 | WB3963-PS10 | VH-10AWG | 35.64 | 39.6 |
| 11 | WB3963-PS11 | VH-11AWG | 39.6 | 43.56 |
| - | - | - | - | - |
| 16 | WB3963-PS16 | VH-16AWG | 59.4 | 63.36 |

| | | | | | | | | | |
|----------------------|-------------------|--|----------|-------------|-------|-------------|------|----------|---|
| 2 | Pin | Tin Plated Brass | N | | | | | | |
| 1 | Housing | PA9T (UL94V-0) | 1 | | | | | | |
| No. | Item/Material No. | Material | QTY | Remark | | | | | |
| Unmarked Tolerance | |  Yueqing Hegxing Electronics Co., Ltd | | | | | | | |
| X. ° ±3° X. X° ±0.5° | | | | | | | | | |
| >0-3 | >3-18 | >18-50 | >50-120 | Unit | Scale | Design Unit | Size | Part No. |   |
| ±0.12 | ±0.15 | ±0.3 | ±0.5 | mm | — | Metric | A4 | | |
| Draw | Review | Approve | Material | Drawing No. | | Part No. | | | |
| | | | Item | VH-NAWG | | | | | |

VH Type Wafer

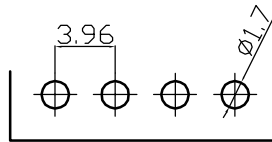
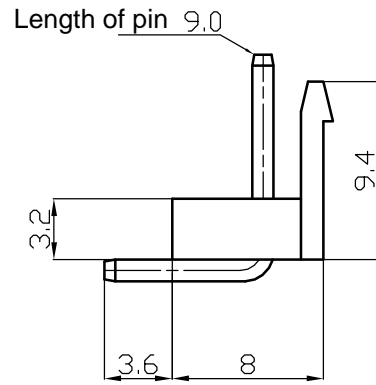
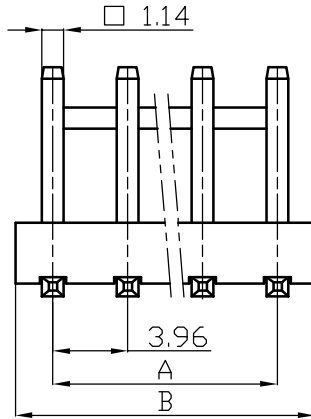

PCB Layout

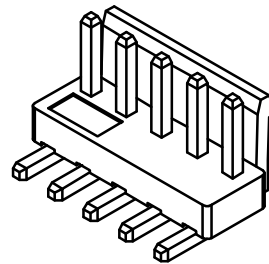



| Poles | Part No. | | Dimensions | |
|-------|--------------|---------|------------|-------|
| | | | A | B |
| 2 | WB3963-PSB02 | VH-2AW | 3.96 | 7.92 |
| 3 | WB3963-PSB03 | VH-3AW | 7.92 | 11.88 |
| 4 | WB3963-PSB04 | VH-4AW | 11.88 | 15.84 |
| 5 | WB3963-PSB05 | VH-5AW | 15.84 | 19.8 |
| 6 | WB3963-PSB06 | VH-6AW | 19.8 | 23.76 |
| 7 | WB3963-PSB07 | VH-7AW | 23.76 | 27.72 |
| 8 | WB3963-PSB08 | VH-8AW | 27.72 | 31.68 |
| 9 | WB3963-PSB09 | VH-9AW | 31.68 | 35.64 |
| 10 | WB3963-PSB10 | VH-10AW | 35.64 | 39.6 |
| 11 | WB3963-PSB11 | VH-11AW | 39.6 | 43.56 |
| - | - | - | - | - |
| 16 | WB3963-PSB16 | VH-16AW | 59.4 | 63.36 |

| 2 | Pin | Tin Plated Brass | N | | | | | | |
|----------------------|-------------------|--------------------------------------|----------|-------------|----------|-------------|------|----------|--|
| 1 | Housing | PA9T (UL94V-0) | 1 | | | | | | |
| No. | Item/Material No. | Material | QTY | Remark | | | | | |
| Unmarked Tolerance | | Yueqing Hegxing Electronics Co., Ltd | | | | | | | |
| X. ° ±3° X. X° ±0.5° | | | | | | | | | |
| >0-3 | >3-18 | >18-50 | >50-120 | Unit | Scale | Design Unit | Size | Part No. | |
| ±0.12 | ±0.15 | ±0.3 | ±0.5 | mm | — | Metric | A4 | | |
| Draw | Review | Approve | Material | Drawing No. | Part No. | | | | |
| | | | | Item | VH-NAW | | | | |

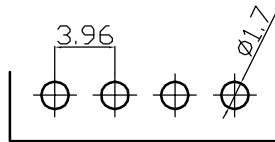
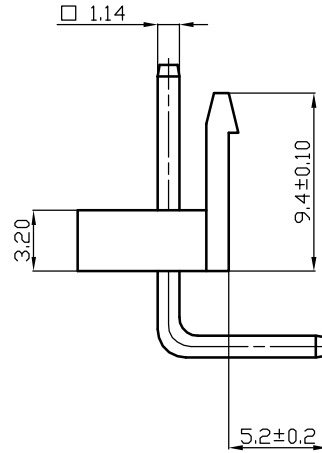
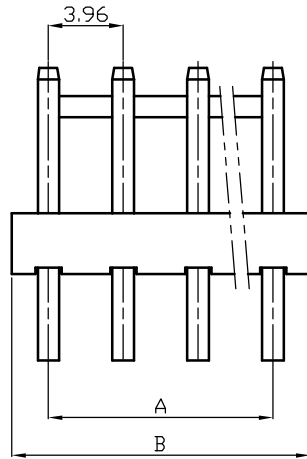
VH Type Wafer





| Poles | Part No. | | Dimensions | |
|-------|--------------|-----------|------------|-------|
| | | | A | B |
| 2 | WB3963-PSF02 | VH-2AWGJ | 3.96 | 7.92 |
| 3 | WB3963-PSF03 | VH-3AWGJ | 7.92 | 11.88 |
| 4 | WB3963-PSF04 | VH-4AWGJ | 11.88 | 15.84 |
| 5 | WB3963-PSF05 | VH-5AWGJ | 15.84 | 19.8 |
| 6 | WB3963-PSF06 | VH-6AWGJ | 19.8 | 23.76 |
| 7 | WB3963-PSF07 | VH-7AWGJ | 23.76 | 27.72 |
| 8 | WB3963-PSF08 | VH-8AWGJ | 27.72 | 31.68 |
| 9 | WB3963-PSF09 | VH-9AWGJ | 31.68 | 35.64 |
| 10 | WB3963-PSF10 | VH-10AWGJ | 35.64 | 39.6 |
| 11 | WB3963-PSF11 | VH-11AWGJ | 39.6 | 43.56 |
| - | - | - | - | - |
| 16 | WB3963-PSF16 | VH-16AWGJ | 59.4 | 63.36 |

| 2 | Pin | Tin Plated Brass | N | | | | | | |
|----------------------|-------------------|--|----------|-------------|----------|-------------|------|----------|---|
| 1 | Housing | PA9T (UL94V-0) | 1 | | | | | | |
| No. | Item/Material No. | Material | QTY | Remark | | | | | |
| Unmarked Tolerance | |  Yueqing Hegxing Electronics Co., Ltd | | | | | | | |
| X. ° ±3° X. X° ±0.5° | | | | | | | | | |
| >0-3 | >3-18 | >18-50 | >50-120 | Unit | Scale | Design Unit | Size | Part No. |   |
| ±0.12 | ±0.15 | ±0.3 | ±0.5 | mm | — | Metric | A4 | | |
| Draw | Review | Approve | Material | Drawing No. | Part No. | | | | |
| | | | | Item | VH-NAWGJ | | | | |

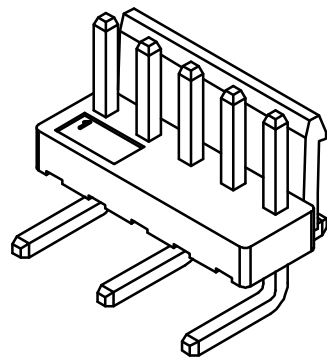
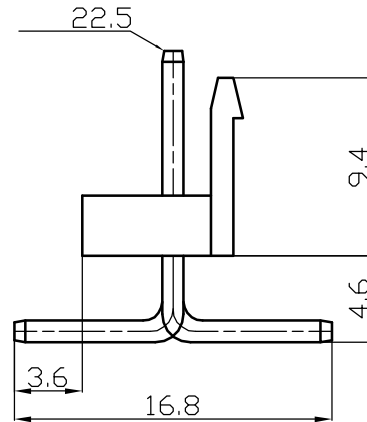
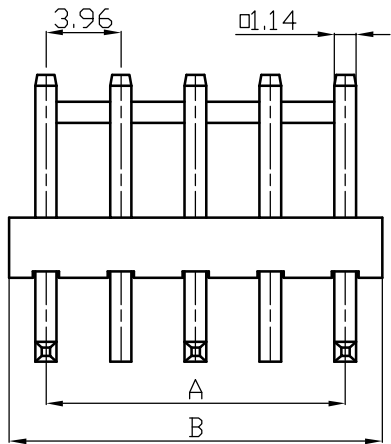
VH Type Wafer



| Poles | Part No. | | Dimensions | |
|-------|-------------|--------|------------|------|
| | A | B | A | B |
| 5 | WB3963-ST05 | VH-5AB | 15.84 | 19.8 |

| 2 | Pin | Tin Plated Brass | N | | | | | | |
|----------------------|-------------------|--|----------|-------------|----------|-------------|------|----------|---|
| 1 | Housing | PA9T (UL94V-0) | 1 | | | | | | |
| No. | Item/Material No. | Material | QTY | Remark | | | | | |
| Unmarked Tolerance | |  Yueqing Hegxing Electronics Co., Ltd | | | | | | | |
| X. ° ±3° X. X° ±0.5° | | | | | | | | | |
| >0-3 | >3-18 | >18-50 | >50-120 | Unit | Scale | Design Unit | Size | Part No. |   |
| ±0.12 | ±0.15 | ±0.3 | ±0.5 | mm | — | Metric | A4 | | |
| Draw | Review | Approve | Material | Drawing No. | Part No. | | | | |
| | | | | Item | VH-NAB | | | | |