

51047 Type Housing

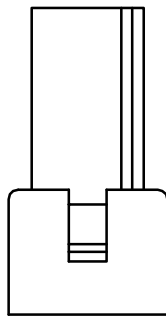

2P

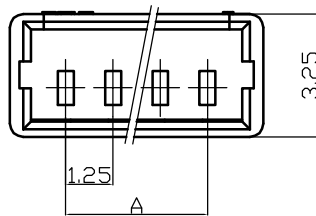

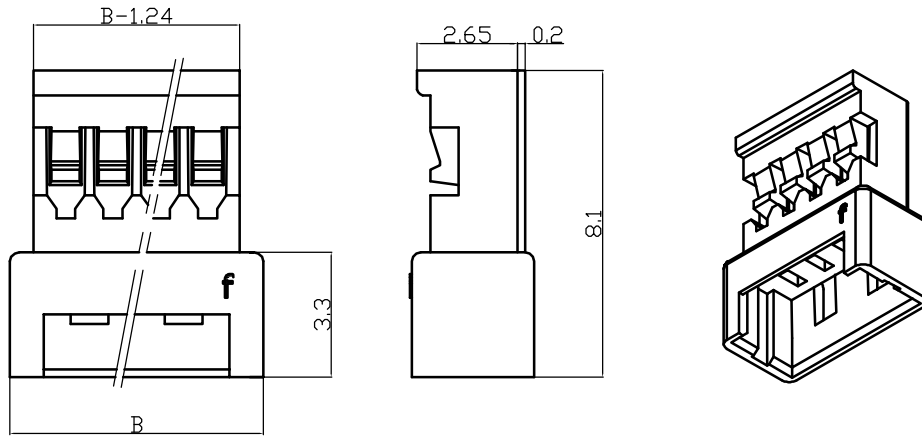
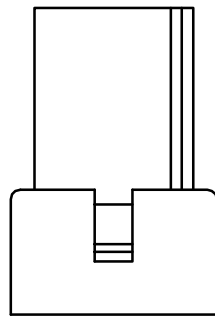

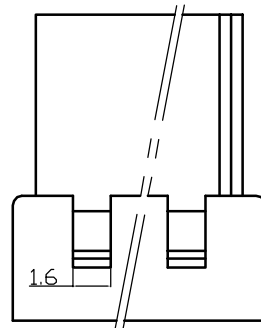
3P





4P~NP

Poles	Part No.		Dimensions	
			A	B
2	WW1251-H02	51047-2A	1.25	4.2
3	WW1251-H03	51047-3A	2.5	5.45
4	WW1251-H04	51047-4A	3.75	6.7
5	WW1251-H05	51047-5A	5	7.95
6	WW1251-H06	51047-6A	6.25	9.2
7	WW1251-H07	51047-7A	7.5	10.45
8	WW1251-H08	51047-8A	8.75	11.7
9	WW1251-H09	51047-9A	10	12.95
10	WW1251-H10	51047-10A	11.25	14.2
11	WW1251-H11	51047-11A	12.5	15.45
-	-	-	-	-
16	WW1251-H16	51047-16A	18.75	21.7

1	Housing	PA66(UL94V-0/V-2)	1	White					
No.	Item/Material No.	Material	QTY	Remark					
Unmarked Tolerance		 Yueqing Hegxing Electronics Co., Ltd							
X. ° ±3° X. X ° ±0.5°									
>0-3	>3-18	>18-50	>50-120	Unit	Scale	Design Unit	Size	Part No.	 
±0.12	±0.15	±0.3	±0.5	mm	—	Metric	A4		
Draw	Review	Approve	Material	Drawing No.	Part No.				
				Item	51047-NA				

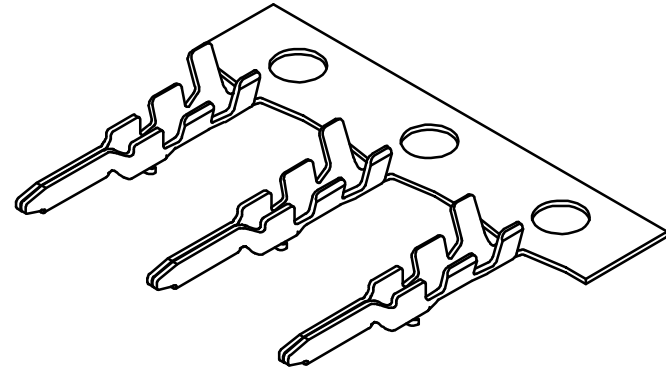
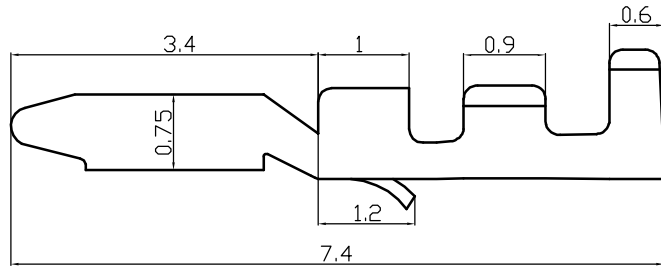
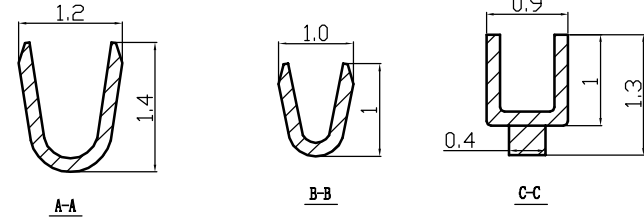
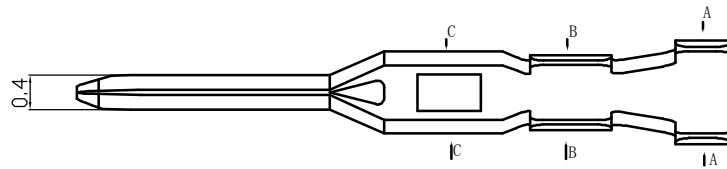
51047 Type Terminal



1	Terminal	Phospher Bronze	1	
No.	Item/Material No.	Material	QTY	Remark
Unmarked Tolerance		 Yueqing Hegxing Electronics Co., Ltd		
X. ° ±3° X. X° ±0.5°				
>0-3	>3-18	>18-50	>50-120	Unit
±0.12	±0.15	±0.3	±0.5	mm
Draw	Review	Approve	Material	Scale
			Drawing No.	Design Unit
			Item	Size
			51047-T	A4
				Part No.
				Part No.

51021 Type Housing

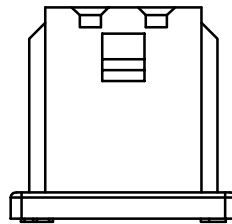
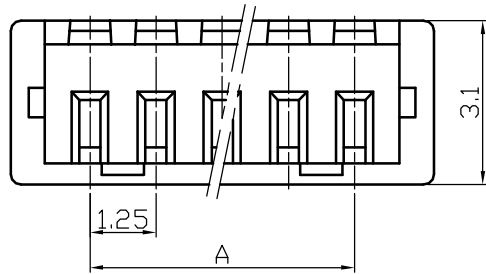
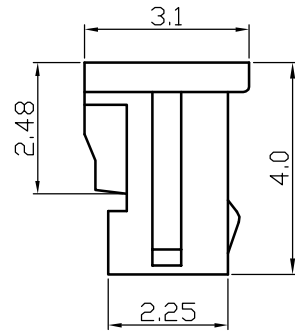
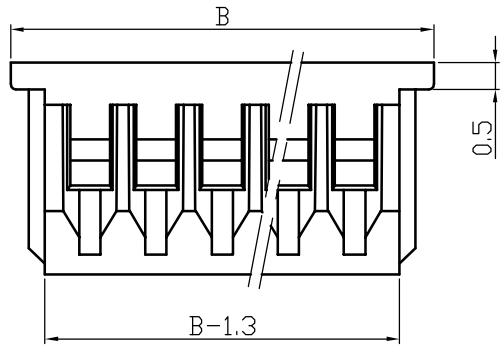

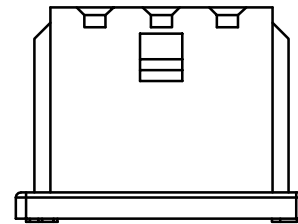

2P

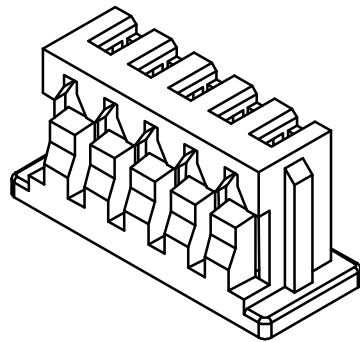

3P



Poles	Part No.		Dimensions	
			A	B
2	WB1251-H02	1.25-2Y	1.25	4.25
3	WB1251-H03	1.25-3Y	2.5	5.5
4	WB1251-H04	1.25-4Y	3.75	6.75
5	WB1251-H05	1.25-5Y	5	8
6	WB1251-H06	1.25-6Y	6.25	9.25
7	WB1251-H07	1.25-7Y	7.5	10.5
8	WB1251-H08	1.25-8Y	8.75	11.75
9	WB1251-H09	1.25-9Y	10	13
10	WB1251-H10	1.25-10Y	11.25	14.25
11	WB1251-H11	1.25-11Y	12.5	15.5
-	-	-	-	-
25	WB1251-H20	1.25-20Y	30	33

1	Housing	PA66 (UL94V-0/V-2)	1						
No.	Item/Material No.	Material	QTY	Remark					
Unmarked Tolerance		 Yueqing Hegxing Electronics Co., Ltd							
X. ° ±3° X. X° ±0.5°									
>0-3	>3-18	>18-50	>50-120	Unit	Scale	Design Unit	Size	Part No.	 
±0.12	±0.15	±0.3	±0.5	mm	—	Metric	A4		
Draw	Review	Approve	Material	Drawing No.			Part No.		
				Item	51021-NY				

51021 Type Terminal

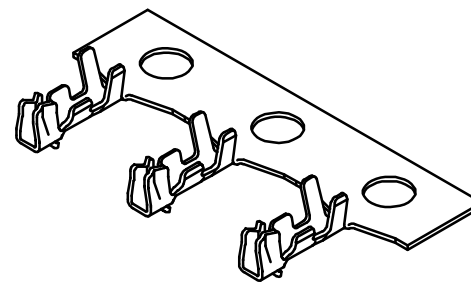
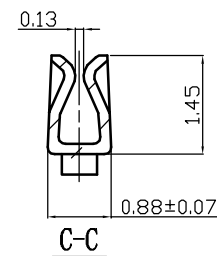
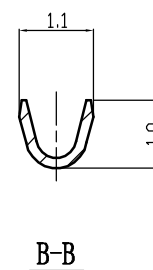
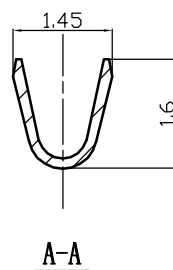
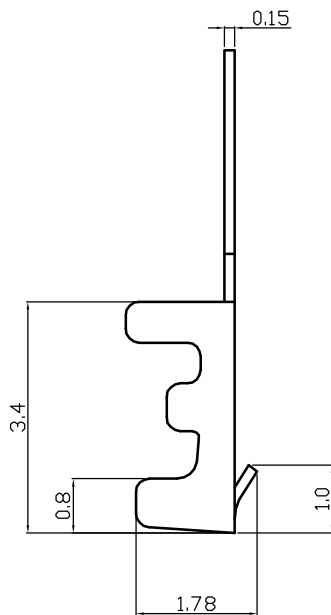
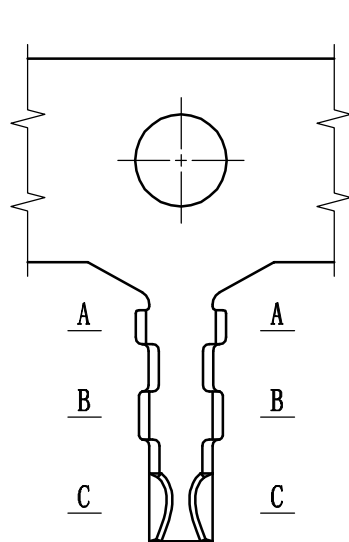

1	Terminal	Phosphor Bronze	1	
No.	Item/Material No.	Material	QTY	Remark
Unmarked Tolerance		 Yueqing Hegxing Electronics Co., Ltd		
X. ° ±3° X. X. ° ±0.5°				
>0-3	>3-18	>18-50	>50-120	
±0.12	±0.15	±0.3	±0.5	
Unit	Scale	Design Unit	Size	Part No.
mm	—	Metric	A4	
Draw	Review	Approve	Material	Drawing No.
				Part No.
			Item	51021-T