

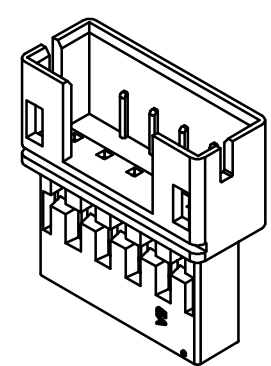

PHR Type Housing

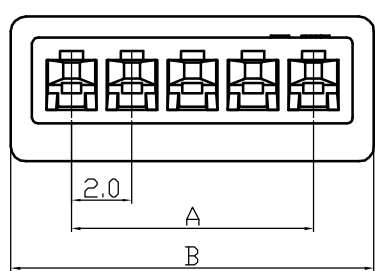

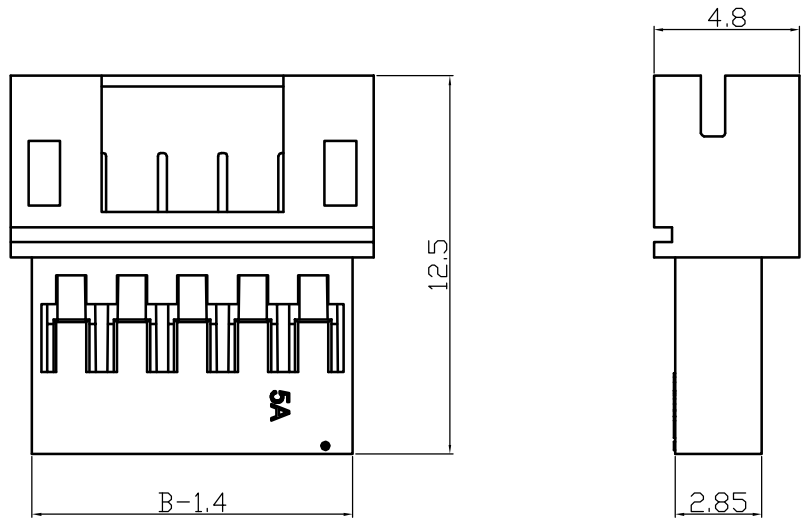

Poles	Part No.		Dimensions	
	A	B	A	B
2	WW2003-H02	PHR-2A	2	6
3	WW2003-H03	PHR-3A	4	8
4	WW2003-H04	PHR-4A	6	10
5	WW2003-H06	PHR-5A	8	12
6	WW2003-H06	PHR-6A	10	14

1	Housing	PA66(UL94V-0/V-2)	1	White
No.	Item/Material No.	Material	QTY	Remark
Unmarked Tolerance		 Yueqing Hegxing Electronics Co., Ltd		
X. ° ±3° X. X° ±0.5°				
>0-3	>3-18	>18-50	>50-120	
±0.12	±0.15	±0.3	±0.5	
Unit	Scale	Design Unit	Size	Part No.
mm	—	Metric	A4	
Draw	Review	Approve	Material	Drawing No.
				Part No.
			Item	PHR-NY

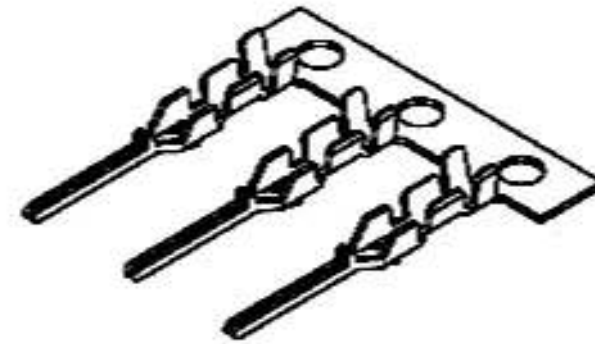
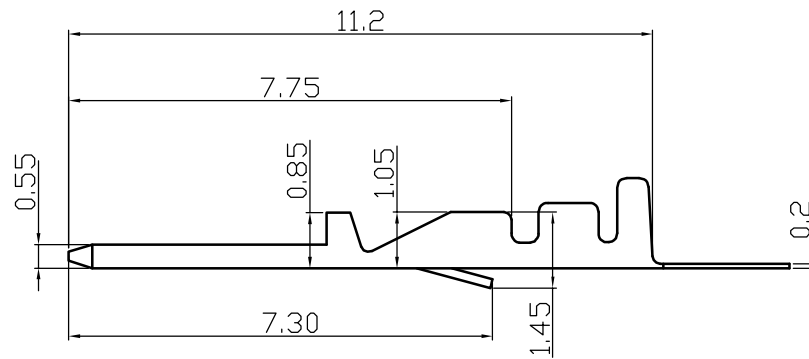
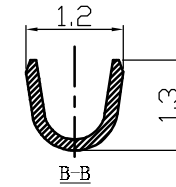
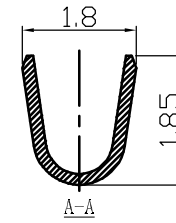
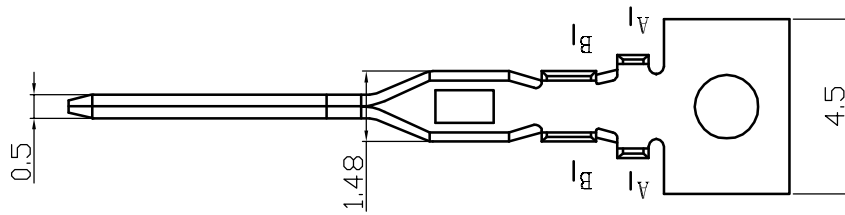
PHR Type Terminal



1	Terminal	Phospher Bronze	1	
No.	Item/Material No.	Material	QTY	Remark
Unmarked Tolerance		 Yueqing Hegxing Electronics Co., Ltd		
X. ° ±3°	X. X° ±0.5°			
>0-3	>3-18	>18-50	>50-120	Unit
±0.12	±0.15	±0.3	±0.5	mm
Scale	Design Unit	Size	Part No.	 
—	Metric	A4		
Draw	Review	Approve	Material	Drawing No.
			Item	PHR-AT11

PH Type Housing

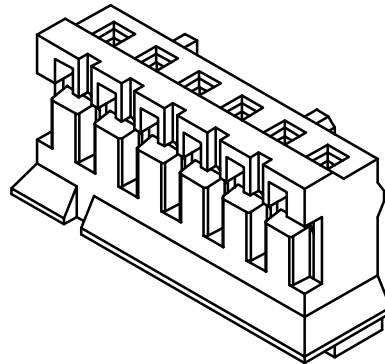
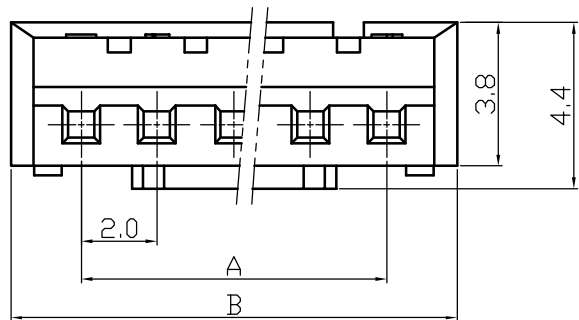
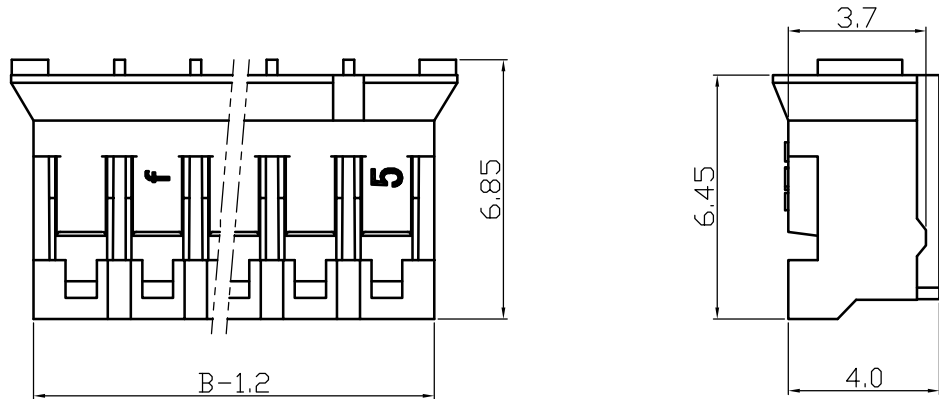

Poles	Part No.		Dimensions	
			A	B
2	WB2001-H02	PH-2Y	2	5.75
3	WB2001-H03	PH-3Y	4	7.75
4	WB2001-H04	PH-4Y	6	9.75
5	WB2001-H06	PH-5Y	8	11.75
6	WB2001-H06	PH-6Y	10	13.75
7	WB2001-H07	PH-7Y	12	15.75
8	WB2001-H08	PH-8Y	14	17.75
9	WB2001-H09	PH-9Y	16	19.75
10	WB2001-H10	PH-10Y	18	21.75
11	WB2001-H11	PH-11Y	20	23.75
-	-	-	-	-
20	WB2001-H20	PH-20Y	38	41.75

1	Housing	PA66(UL94V-0/V-2)	1	White					
No.	Item/Material No.	Material	QTY	Remark					
Unmarked Tolerance		 Yueqing Hegxing Electronics Co., Ltd							
X. ° ±3° X. X° ±0.5°									
>0-3	>3-18	>18-50	>50-120	Unit	Scale	Design Unit	Size	Part No.	 
±0.12	±0.15	±0.3	±0.5	mm	—	Metric	A4		
Draw	Review	Approve	Material	Drawing No.			Part No.		
				Item	PH-NY				

PH Type Terminal

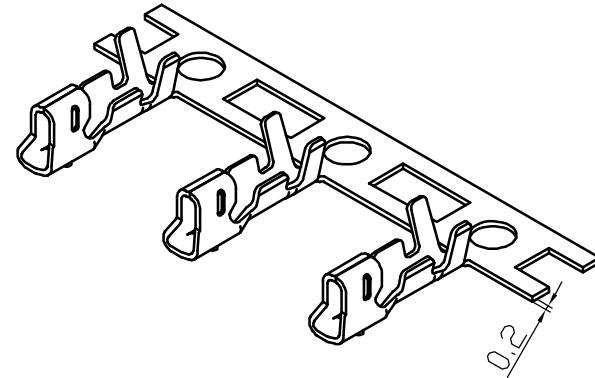
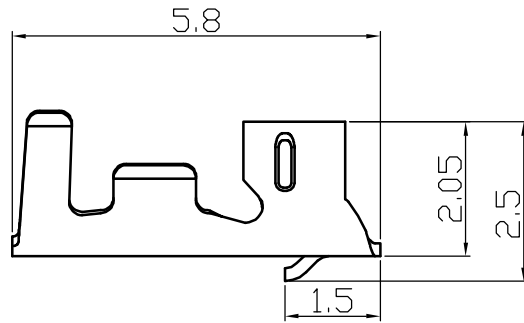
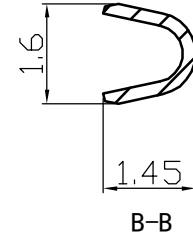
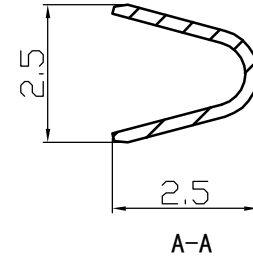
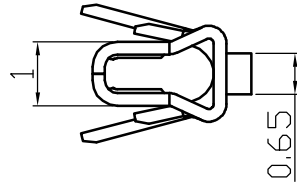
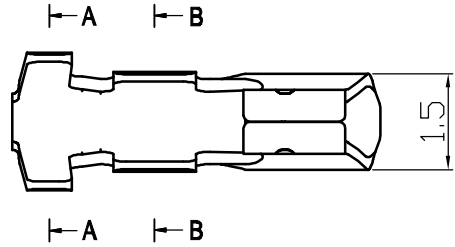

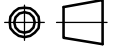
1	Terminal	Phospher Bronze	1	
No.	Item/Material No.	Material	QTY	Remark
Unmarked Tolerance		 Yueqing Hegxing Electronics Co., Ltd		
X. ° ±3° X. X° ±0.5°				
>0-3	>3-18	>18-50	>50-120	Unit
±0.12	±0.15	±0.3	±0.5	mm
Scale	Design Unit	Size	Part No.	
—	Metric	A4		
Draw	Review	Approve	Material	Drawing No.
			Item	PH-YT