

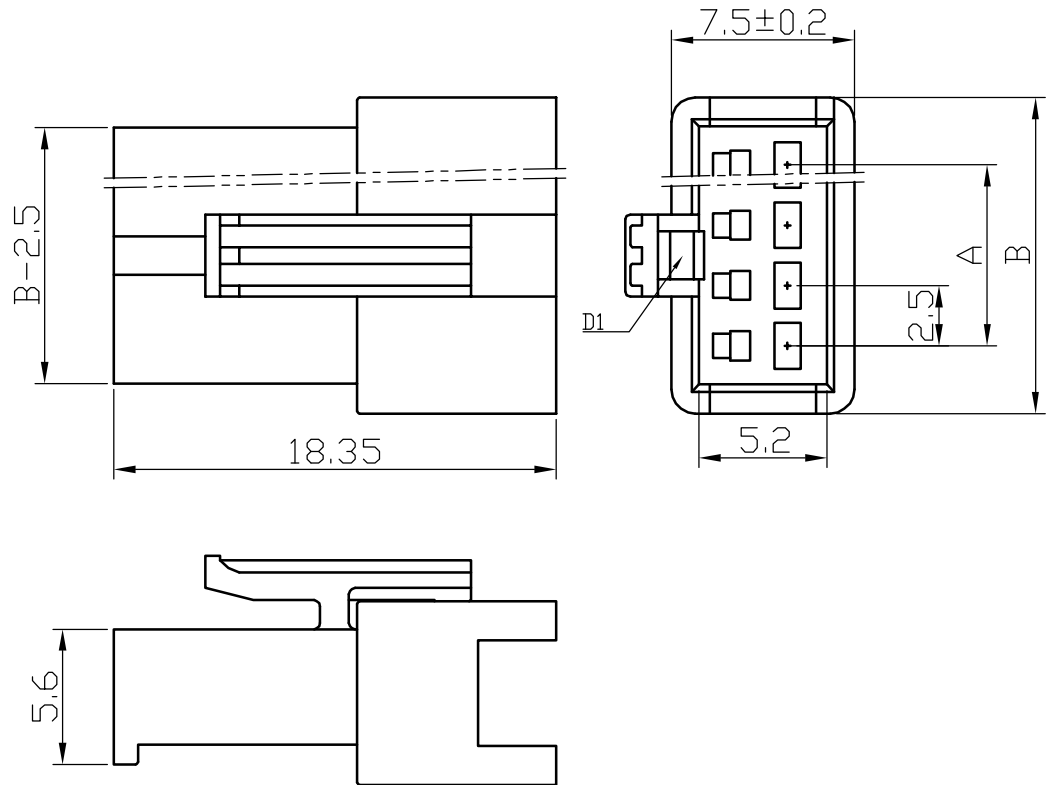



SM Type Housing



Poles	Part No.		Dimensions	
			A	B
2	WW2501-H02	SM-2A	2.5	8.1
3	WW2501-H03	SM-3A	5	10.6
4	WW2501-H04	SM-4A	7.5	13.1
5	WW2501-H05	SM-5A	10	15.6
6	WW2501-H06	SM-6A	12.5	18.1
7	WW2501-H07	SM-7A	15	20.6
8	WW2501-H08	SM-8A	17.5	23.1
9	WW2501-H09	SM-9A	20	25.6
10	WW2501-H10	SM-10A	22.5	28.1
11	WW2501-H11	SM-11A	25	30.6
-	-	-	-	-
16	WW2501-H16	SM-16A	37.5	43.1

1	Housing	PA66(UL94V-0/V-2)	1	White					
No.	Item/Material No.	Material	QTY	Remark					
Unmarked Tolerance		 Yueqing Hegxing Electronics Co., Ltd							
X.° ±3° X.X° ±0.5°									
>0-3	>3-18	>18-50	>50-120	Unit	Scale	Design Unit	Size	Part No.	 
±0.12	±0.15	±0.3	±0.5	mm	—	Metric	A4		
Draw	Review	Approve	Material	Drawing No.			Part No.		
				Item	SM-NA				

SM Type Housing

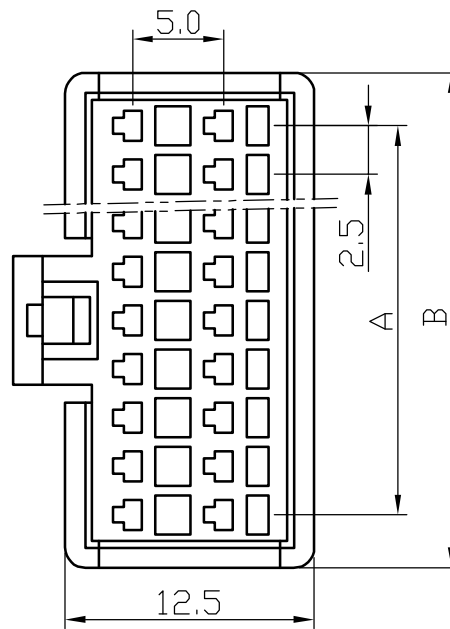
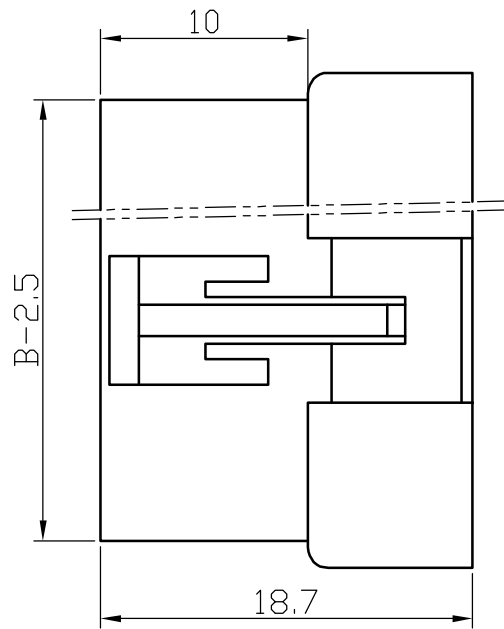

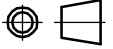

Poles	Part No.		Dimensions	
			A	B
14	WW2501-H07x2	SM-2x7A	15	20.5
16	WW2501-H08x2	SM-2x8A	17	23
18	WW2501-H09x2	SM-2x9A	19	25.5
20	WW2501-H10x2	SM-2x10A	21	28
22	WW2501-H11x2	SM-2x11A	23	30.5
24	WW2501-H12x2	SM-2x12A	25	33

1	Housing	PA66(UL94V-0/V-2)	1	White					
No.	Item/Material No.	Material	QTY	Remark					
Unmarked Tolerance		 Yueqing Hegxing Electronics Co., Ltd							
X. ° ±3° X. X° ±0.5°									
>0-3	>3-18	>18-50	>50-120	Unit	Scale	Design Unit	Size	Part No.	
±0.12	±0.15	±0.3	±0.5	mm	—	Metric	A4		
Draw	Review	Approve	Material	Drawing No.	Part No.				
				Item	SM-2xNA				

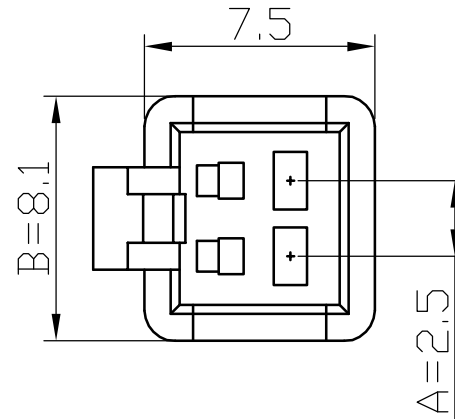
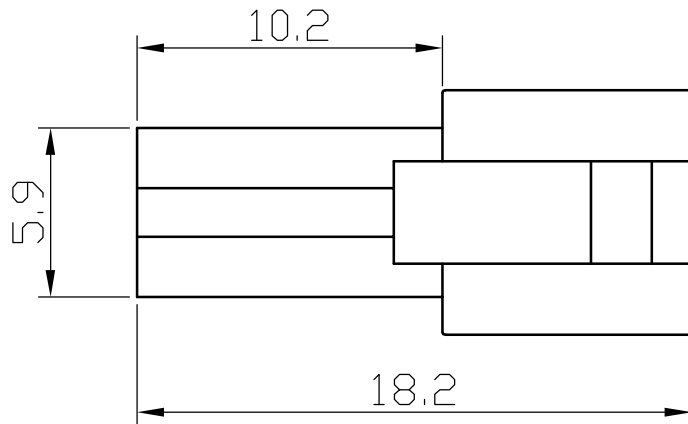
SM Type Housing





Poles	Part No.	Dimensions	
		A	B
2	WW2501-HB02	2.5	8.1

1	Housing	PA66(UL94V-0/V-2)	1	White					
No.	Item/Material No.	Material	QTY	Remark					
Unmarked Tolerance		 Yueqing Hegxing Electronics Co., Ltd							
X. ° ±3° X. X° ±0.5°									
>0-3	>3-18	>18-50	>50-120	Unit	Scale	Design Unit	Size	Part No.	 
±0.12	±0.15	±0.3	±0.5	mm	—	Metric	A4		
Draw	Review	Approve	Material	Drawing No.		Part No.			
			Item						

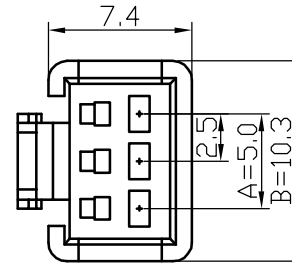
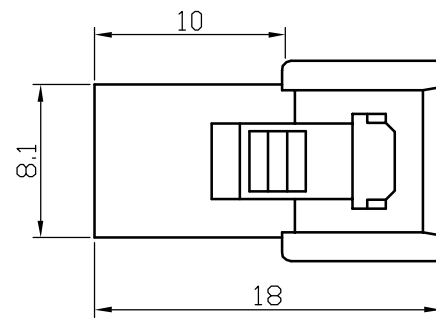
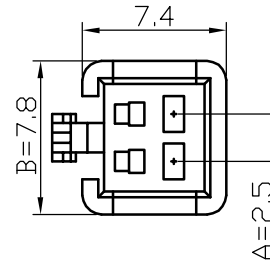
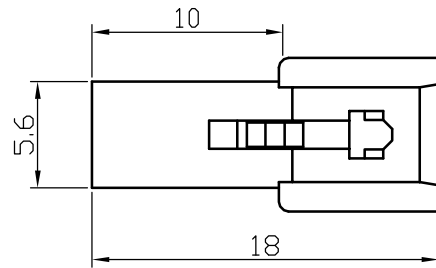
SM Type Housing



Poles	Part No.	Dimensions	
		A	B
2	WW2501-HC02	2.5	7.8
3	WW2501-HC03	5	10.3

1	Housing	PA66(UL94V-0/V-2)	1	White					
No.	Item/Material No.	Material	QTY	Remark					
Unmarked Tolerance		 Yueqing Hegxing Electronics Co., Ltd							
X. ° ±3° X. X° ±0.5°									
>0-3	>3-18	>18-50	>50-120	Unit	Scale	Design Unit	Size	Part No.	 
±0.12	±0.15	±0.3	±0.5	mm	—	Metric	A4		
Draw	Review	Approve	Material	Drawing No.			Part No.		
				Item					

SM Type Housing

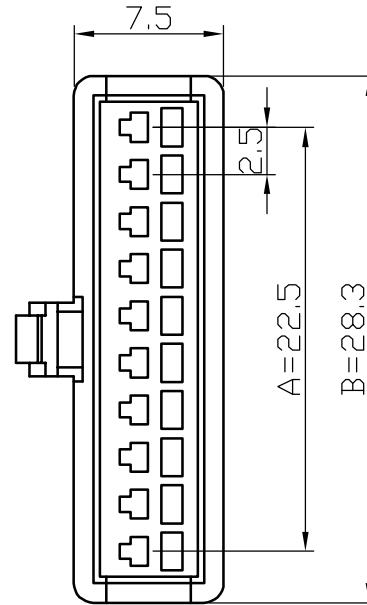
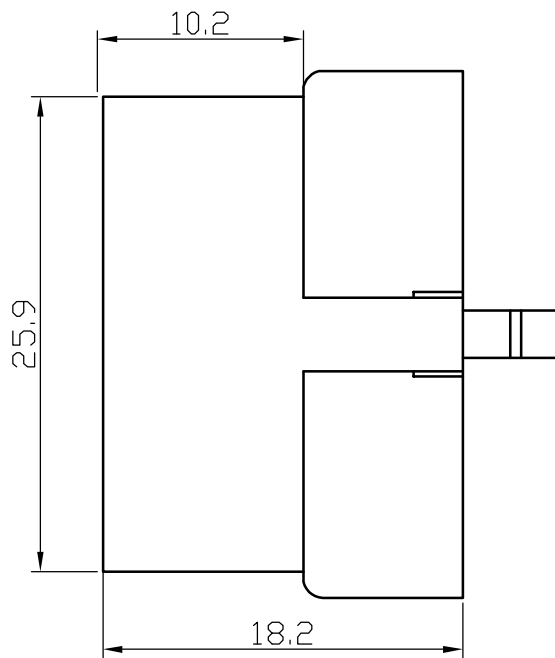

Poles	Part No.	Dimensions	
		A	B
2	WW2501-HD10	22.5	28.3

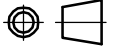
1	Housing	PA66(UL94V-0/V-2)	1	White					
No.	Item/Material No.	Material	QTY	Remark					
Unmarked Tolerance		 Yueqing Hegxing Electronics Co., Ltd							
X. ° ±3° X. X° ±0.5°									
>0-3	>3-18	>18-50	>50-120	Unit	Scale	Design Unit	Size	Part No.	
±0.12	±0.15	±0.3	±0.5	mm	—	Metric	A4		
Draw	Review	Approve	Material	Drawing No.			Part No.		
				Item					

SM Type Terminal

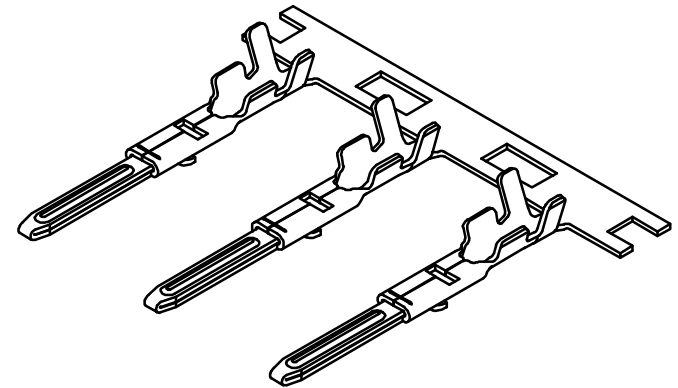
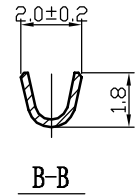
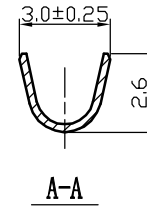
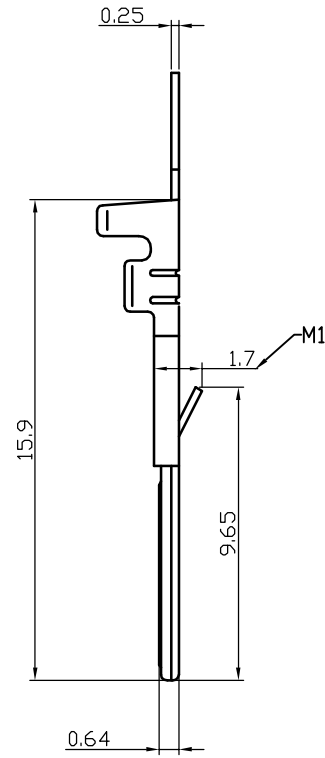
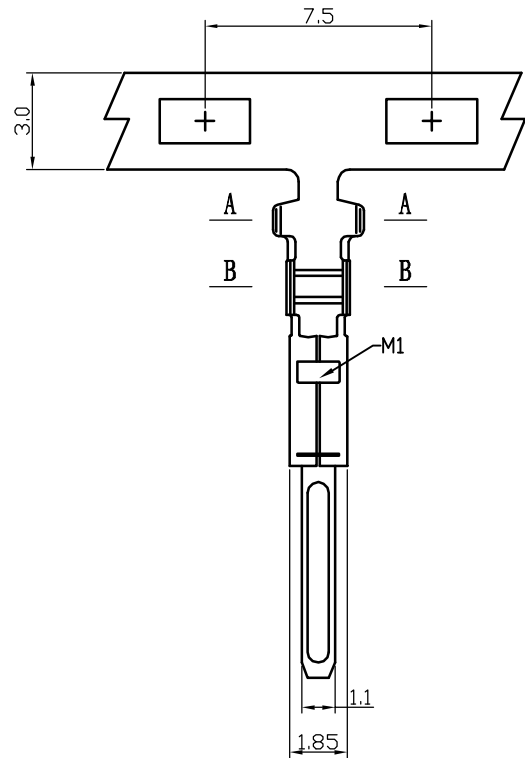

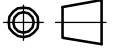
1	Terminal	Phospher Bronze	1						
No.	Item/Material No.	Material	QTY	Remark					
Unmarked Tolerance		 Yueqing Hegxing Electronics Co., Ltd							
X.° ±3° X.X° ±0.5°									
>0-3	>3-18	>18-50	>50-120	Unit	Scale	Design Unit	Size	Part No.	
±0.12	±0.15	±0.3	±0.5	mm	—	Metric	A4		
Draw	Review	Approve	Material	Drawing No.			Part No.		
				Item	SM-AT				

SM Type Housing

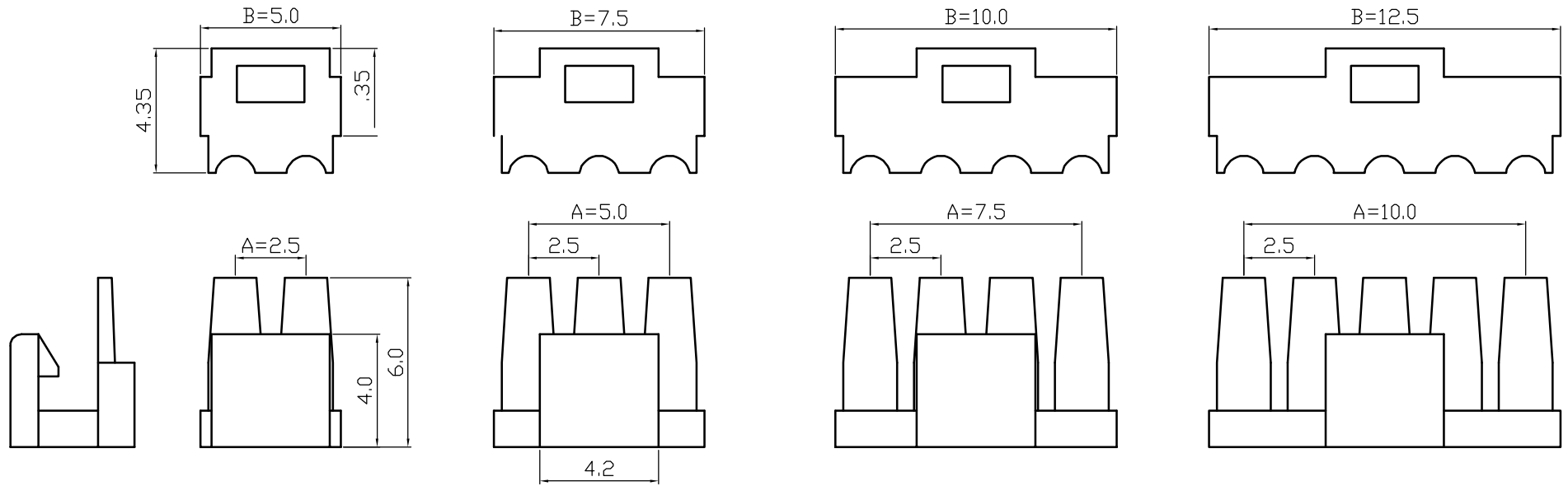

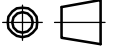

Poles	Part No.		Dimensions	
			A	B
2	WW2501-F02	SM-2RST	2.5	5
3	WW2501-F03	SM-3RST	5	7.5
4	WW2501-F04	SM-4RST	7.5	10
5	WW2501-F05	SM-5RST	10	12.5

1	Housing	PA66(UL94V-0/V-2)	1	White					
No.	Item/Material No.	Material	QTY	Remark					
Unmarked Tolerance		 Yueqing Hegxing Electronics Co., Ltd							
X. ° ±3° X. X° ±0.5°									
>0-3	>3-18	>18-50	>50-120	Unit	Scale	Design Unit	Size	Part No.	
±0.12	±0.15	±0.3	±0.5	mm	—	Metric	A4		
Draw	Review	Approve	Material	Drawing No.	Part No.				
				Item	SM-NRST				

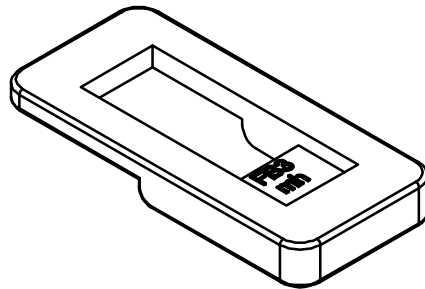
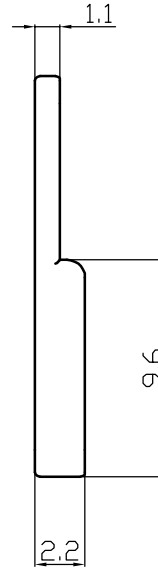
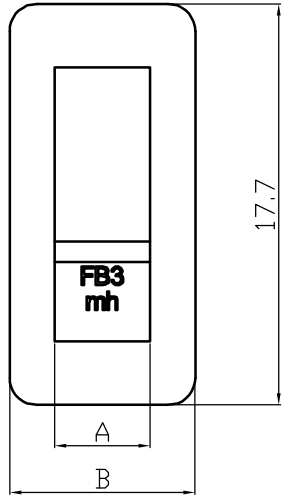
SM Type Housing



Poles	Part No.		Dimensions	
			A	B
2	WW2501-FB02	SMB-2P	3.7	7.6
3	WW2501-FB03	SMB-3P	4.2	8.2

1	Housing	PA66(UL94V-0/V-2)	1	White					
No.	Item/Material No.	Material	QTY	Remark					
Unmarked Tolerance		 Yueqing Hegxing Electronics Co., Ltd							
X. ° ±3° X. X° ±0.5°									
>0-3	>3-18	>18-50	>50-120	Unit	Scale	Design Unit	Size	Part No.	 
±0.12	±0.15	±0.3	±0.5	mm	—	Metric	A4		
Draw	Review	Approve	Material	Drawing No.	Part No.				
			Item	SMB-NP					

SM Type Housing

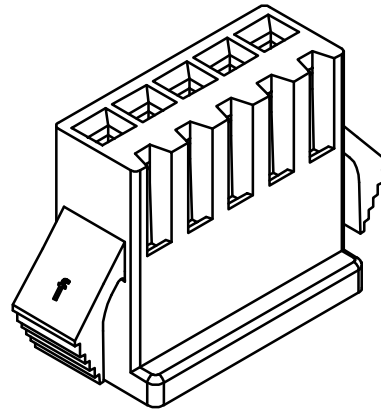
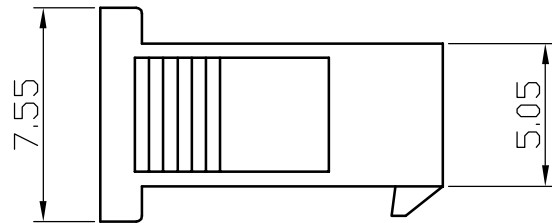
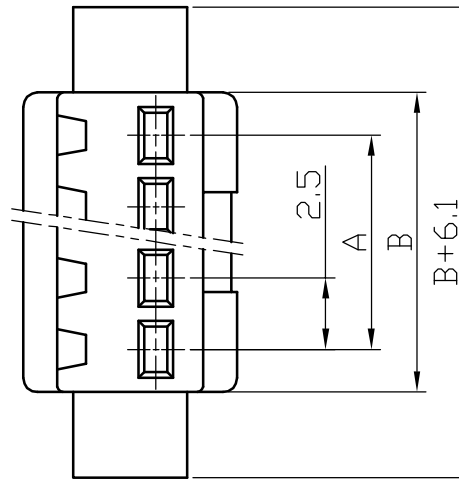
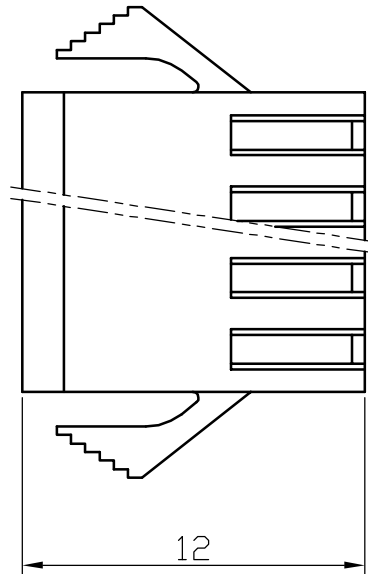

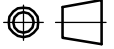

Poles	Part No.		Dimensions	
			A	B
2	WW2502-H02	SM-2Y	2.5	5.5
3	WW2502-H03	SM-3Y	5	8
4	WW2502-H04	SM-4Y	7.5	10.5
5	WW2502-H05	SM-5Y	10	13
6	WW2502-H06	SM-6Y	12.5	15.5
7	WW2502-H07	SM-7Y	15	18
8	WW2502-H08	SM-8Y	17.5	20.5
9	WW2502-H09	SM-9Y	20	23
10	WW2502-H10	SM-10Y	22.5	25.5
11	WW2502-H11	SM-11Y	25	28
-	-	-	-	-
16	WW2502-H16	SM-16Y	37.5	40.5

1	Housing	PA66(UL94V-0/V-2)	1	White					
No.	Item/Material No.	Material	QTY	Remark					
Unmarked Tolerance		 Yueqing Hegxing Electronics Co., Ltd							
X. °	±3°				X. X. °	±0.5°			
>0-3	>3-18	>18-50	>50-120	Unit	Scale	Design Unit	Size	Part No.	
±0.12	±0.15	±0.3	±0.5	mm	—	Metric	A4		
Draw	Review	Approve	Material	Drawing No.			Part No.		
				Item	SM-NY				

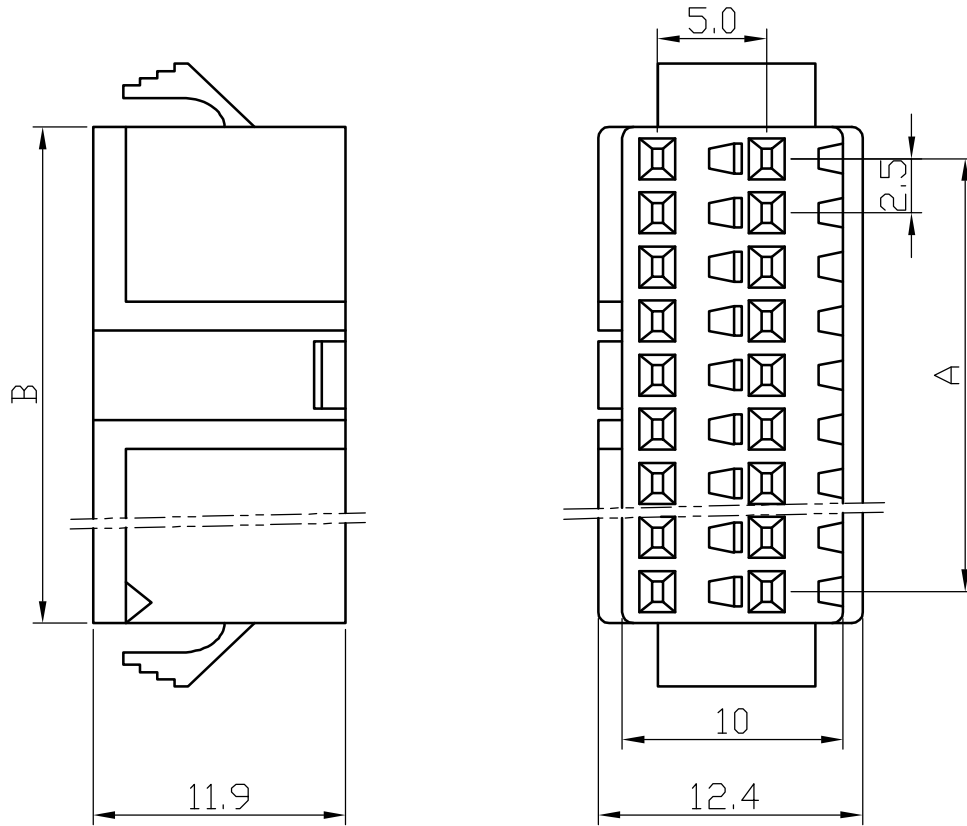
SM Type Housing





Poles	Part No.		Dimensions	
			A	B
14	WW2502-H07x2	SM-2x7Y	15	18
16	WW2502-H08x2	SM-2x8Y	17.5	20.5
18	WW2502-H09x2	SM-2x9Y	20	23
20	WW2502-H10x2	SM-2x10Y	22.5	25.5
22	WW2502-H11x2	SM-2x11Y	25	28
24	WW2502-H12x2	SM-2x12Y	27.5	30.5

1	Housing	PA66(UL94V-0/V-2)	1	White					
No.	Item/Material No.	Material	QTY	Remark					
Unmarked Tolerance		 Yueqing Hegxing Electronics Co., Ltd							
X. ° ±3° X. X° ±0.5°									
>0-3	>3-18	>18-50	>50-120	Unit	Scale	Design Unit	Size	Part No.	 
±0.12	±0.15	±0.3	±0.5	mm	—	Metric	A4		
Draw	Review	Approve	Material	Drawing No.	Part No.				
				Item	SM-NY-96				

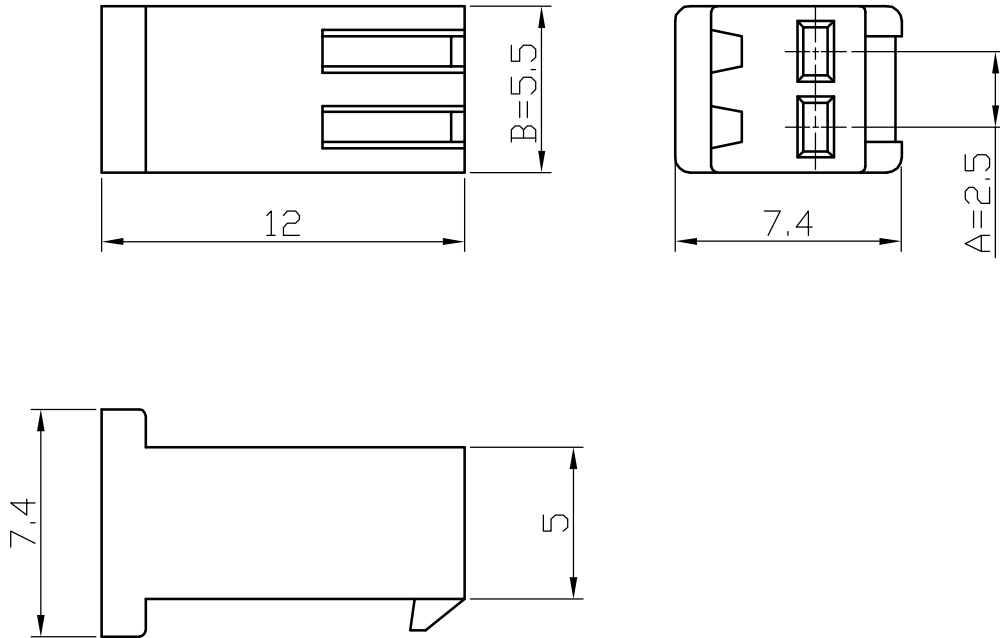
SM Type Housing



Poles	Part No.	Dimensions	
		A	B
2	WW2502-HB02	2.5	5.5

1	Housing	PA66(UL94V-0/V-2)	1	White					
No.	Item/Material No.	Material	QTY	Remark					
Unmarked Tolerance		 Yueqing Hegxing Electronics Co., Ltd							
X. ° ±3° X. X° ±0.5°									
>0-3	>3-18	>18-50	>50-120	Unit	Scale	Design Unit	Size	Part No.	 
±0.12	±0.15	±0.3	±0.5	mm	—	Metric	A4		
Draw	Review	Approve	Material	Drawing No.	Part No.				
				Item					

SM Type Housing

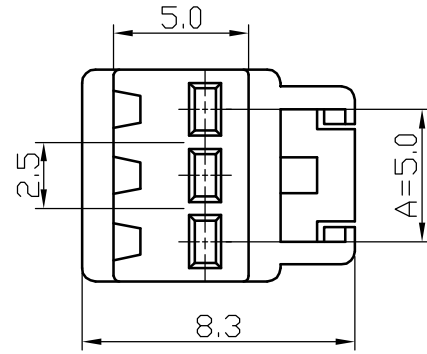
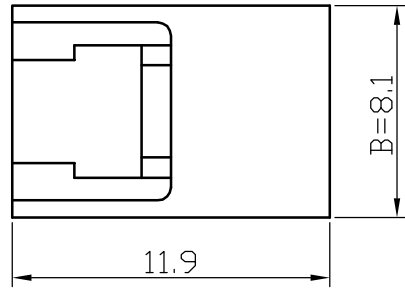
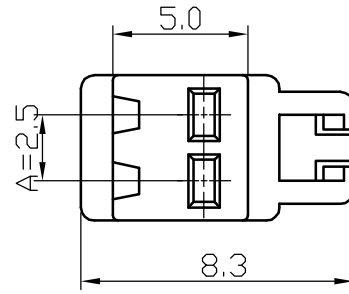
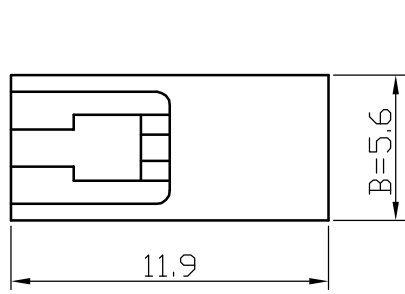

Poles	Part No.	Dimensions	
		A	B
2	WW2502-HC02	2.5	5.6
3	WW2502-HC03	5	8.1

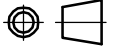
1	Housing	PA66(UL94V-0/V-2)	1	White					
No.	Item/Material No.	Material	QTY	Remark					
Unmarked Tolerance		 Yueqing Hegxing Electronics Co., Ltd							
X. ° ±3° X. X° ±0.5°									
>0-3	>3-18	>18-50	>50-120	Unit	Scale	Design Unit	Size	Part No.	
±0.12	±0.15	±0.3	±0.5	mm	—	Metric	A4		
Draw	Review	Approve	Material	Drawing No.	Part No.				
				Item					

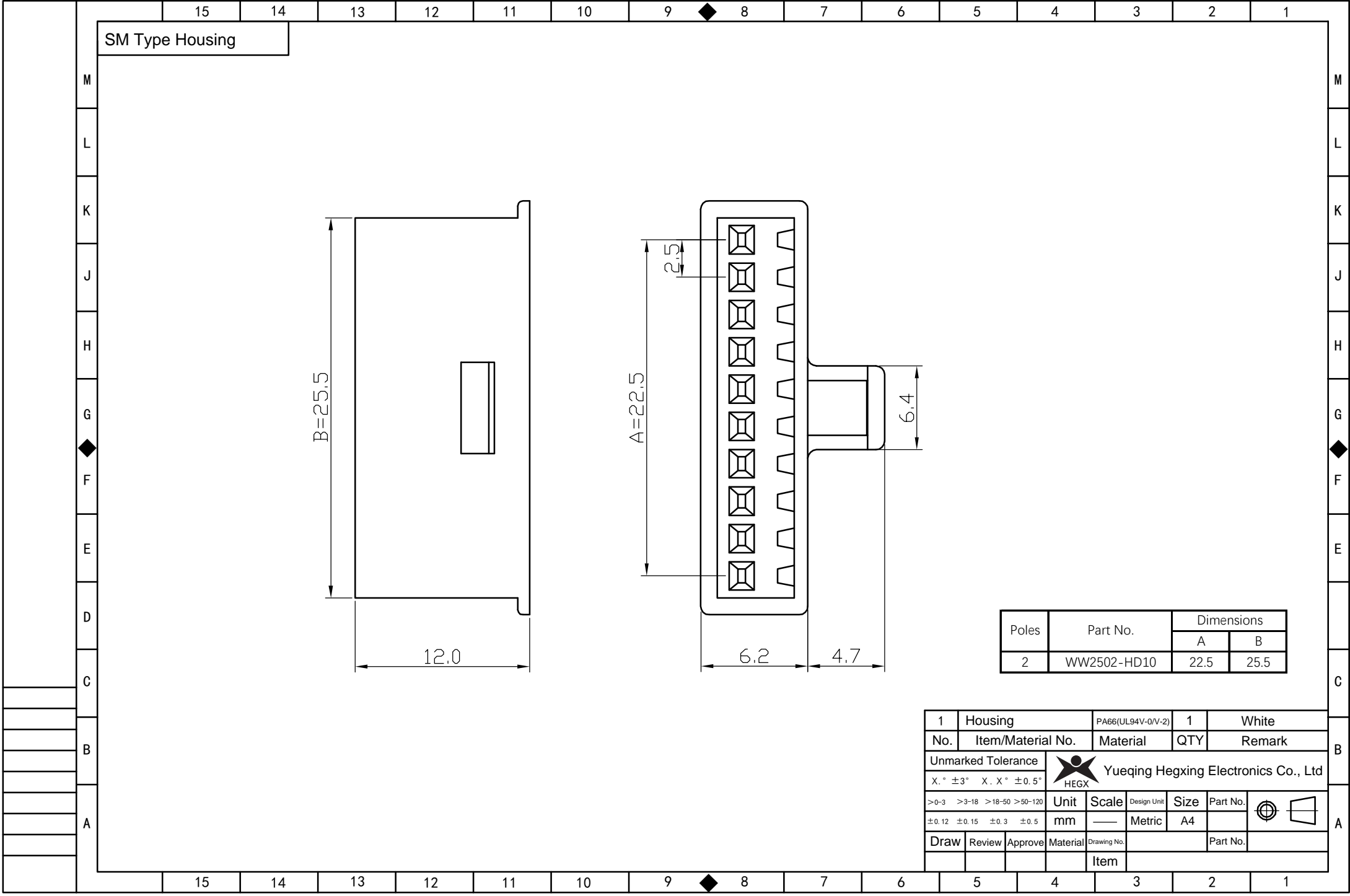

SM Type Housing

B=25.5

12.0

A=22.5

6.2

4.7

2.5

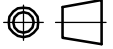

6.4

Poles	Part No.	Dimensions	
		A	B
2	WW2502-HD10	22.5	25.5

1	Housing	PA66(UL94V-0/V-2)	1	White					
No.	Item/Material No.	Material	QTY	Remark					
Unmarked Tolerance		 Yueqing Hegxing Electronics Co., Ltd							
X. ° ±3°	X. X° ±0.5°								
>0-3	>3-18	>18-50	>50-120	Unit	Scale	Design Unit	Size	Part No.	
±0.12	±0.15	±0.3	±0.5	mm	—	Metric	A4		
Draw	Review	Approve	Material	Drawing No.	Part No.				
				Item					

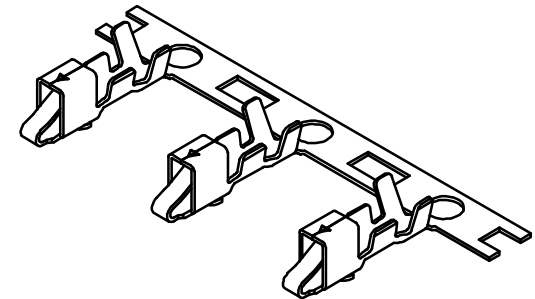
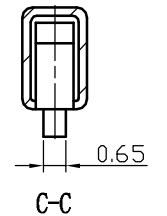
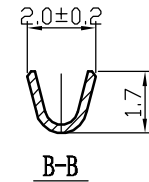
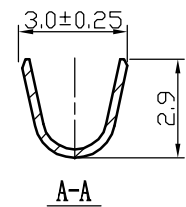
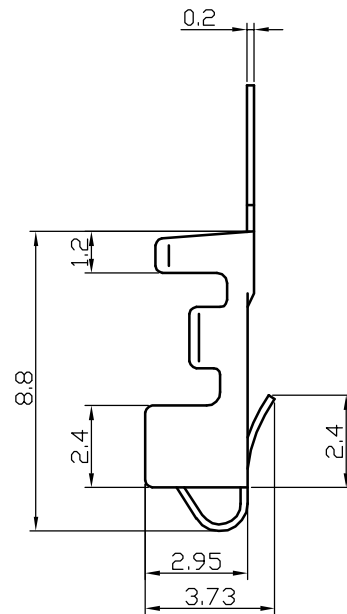
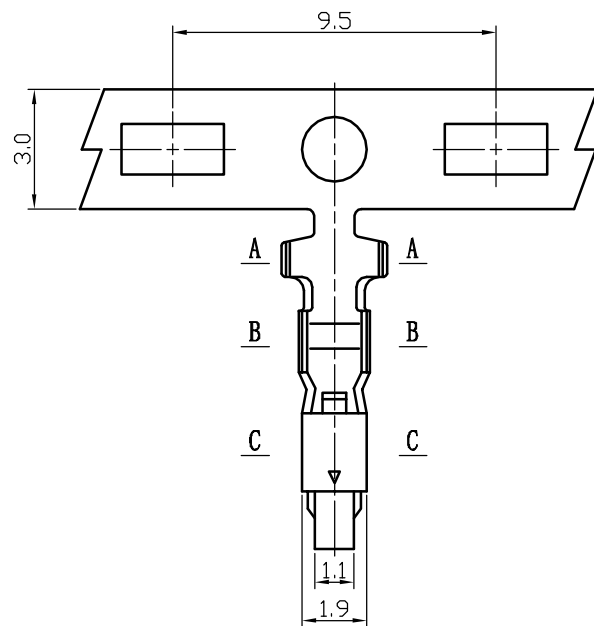
SM Type Terminal



1	Terminal	Phospher Bronze	1						
No.	Item/Material No.	Material	QTY	Remark					
Unmarked Tolerance		 Yueqing Hegxing Electronics Co., Ltd							
X. ° ±3° X. X° ±0.5°									
>0-3	>3-18	>18-50	>50-120	Unit	Scale	Design Unit	Size	Part No.	 
±0.12	±0.15	±0.3	±0.5	mm	—	Metric	A4		
Draw	Review	Approve	Material	Drawing No.			Part No.		
				Item	SM-YT				