

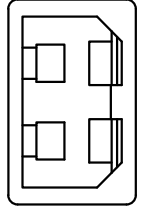

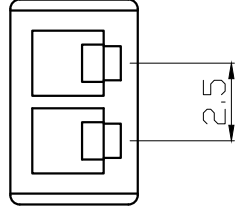

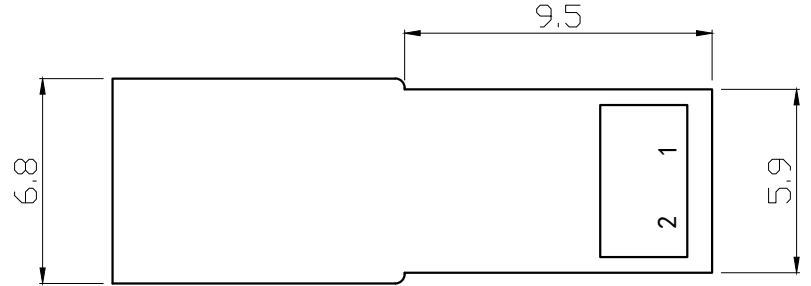

SY Type Housing

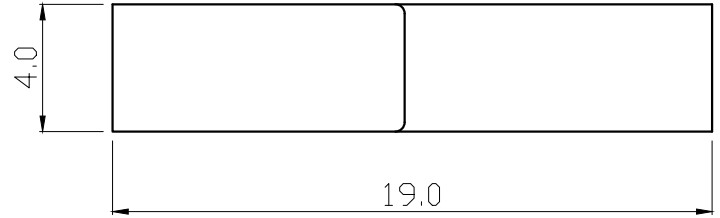

1	Housing	PA66(UL94V-0/V-2)	1	White					
No.	Item/Material No.	Material	QTY	Remark					
Unmarked Tolerance		 Yueqing Hegxing Electronics Co., Ltd							
X. ° ±3°	X. X° ±0.5°								
>0-3	>3-18	>18-50	>50-120	Unit	Scale	Design Unit	Size	Part No.	 
±0.12	±0.15	±0.3	±0.5	mm	—	Metric	A4		
Draw	Review	Approve	Material	Drawing No.	Part No.				
				Item	SY-2A				

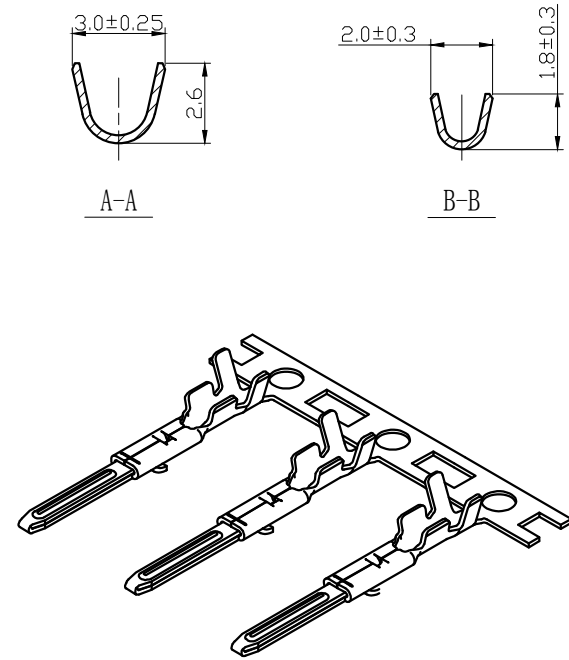
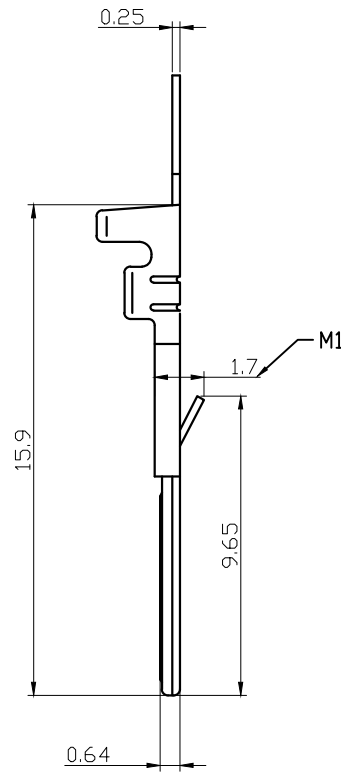
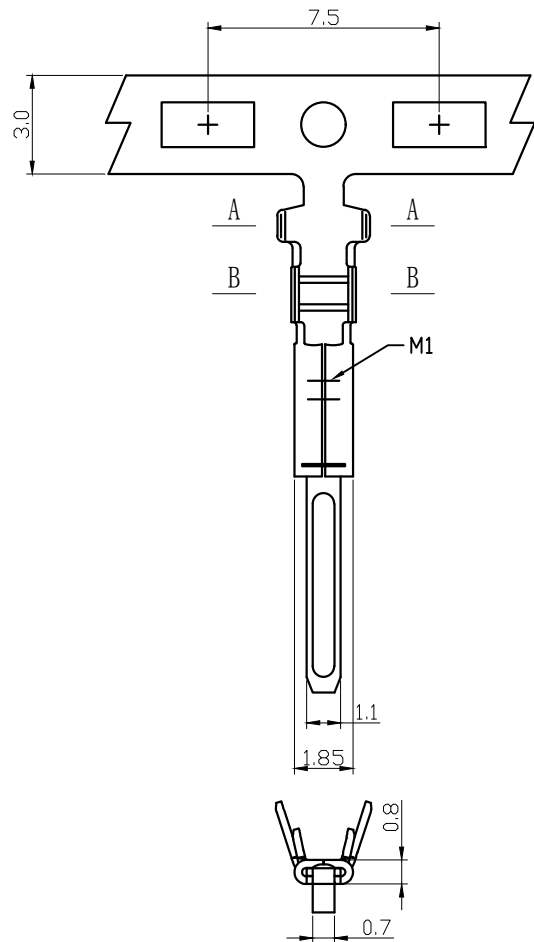
SM Type Terminal



1	Terminal	Phospher Bronze	1	
No.	Item/Material No.	Material	QTY	Remark
Unmarked Tolerance		 Yueqing Hegxing Electronics Co., Ltd		
X. ° ±3°	X. X° ±0.5°			
>0-3	>3-18	>18-50	>50-120	
Unit	Scale	Design Unit	Size	Part No.
mm	—	Metric	A4	
Draw	Review	Approve	Material	Drawing No.
			Item	SM-AT

SY Type Housing

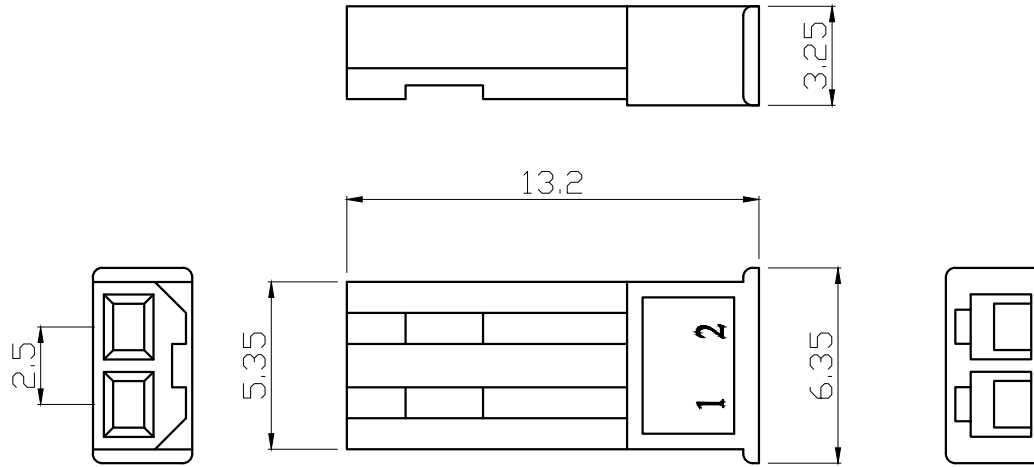

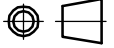
1	Housing	PA66(UL94V-0/V-2)	1	White					
No.	Item/Material No.	Material	QTY	Remark					
Unmarked Tolerance		 Yueqing Hegxing Electronics Co., Ltd							
X. ° ±3° X. X° ±0.5°									
>0-3	>3-18	>18-50	>50-120	Unit	Scale	Design Unit	Size	Part No.	
±0.12	±0.15	±0.3	±0.5	mm	—	Metric	A4		
Draw	Review	Approve	Material	Drawing No.	Part No.				
				Item	SY-2Y				

SM Type Terminal

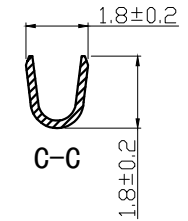
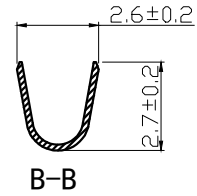
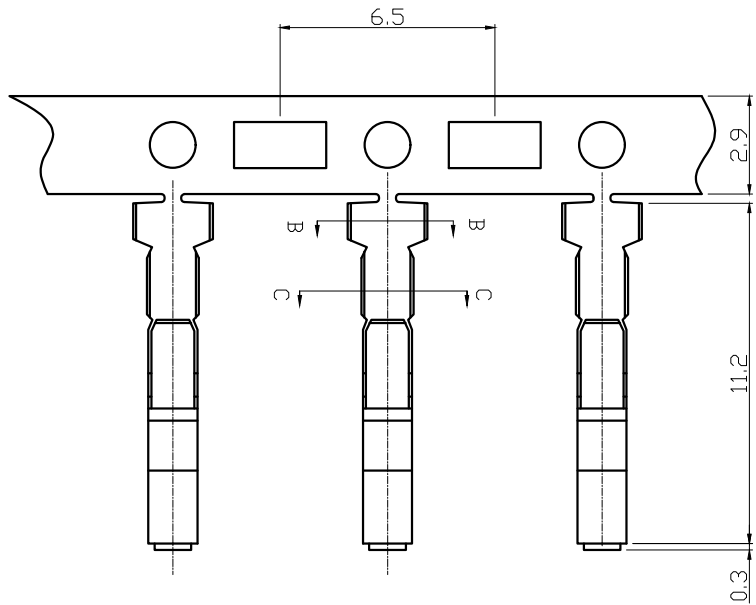
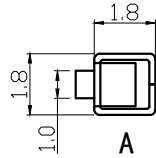
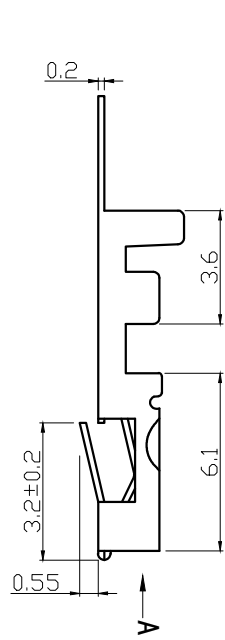

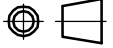
1	Terminal	Phospher Bronze	1						
No.	Item/Material No.	Material	QTY	Remark					
Unmarked Tolerance		 Yueqing Hegxing Electronics Co., Ltd							
X.° ±3° X.X° ±0.5°									
>0-3	>3-18	>18-50	>50-120	Unit	Scale	Design Unit	Size	Part No.	
±0.12	±0.15	±0.3	±0.5	mm	—	Metric	A4		
Draw	Review	Approve	Material	Drawing No.			Part No.		
				Item	SYP-PT				