

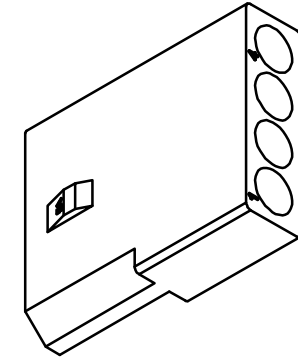

5500 Type Housing

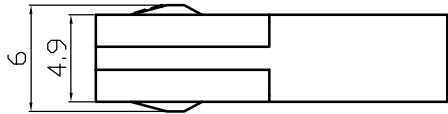

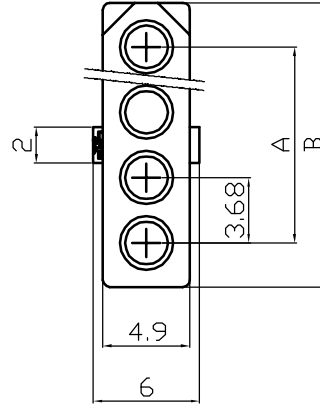
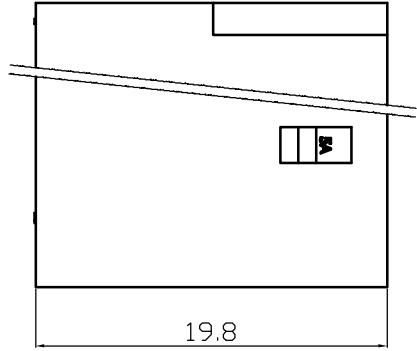

Poles	Part No.		Dimensions	
			A	B
2	WW3681-H02	5500-2Y	3.68	8.64
3	WW3681-H03	5500-3Y	7.36	12.32
4	WW3681-H04	5500-4Y	11.04	16
5	WW3681-H05	5500-5Y	14.72	19.68

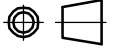
1	Housing	PA66(UL94V-0/V-2)	1	White					
No.	Item/Material No.	Material	QTY	Remark					
Unmarked Tolerance		 Yueqing Hegxing Electronics Co., Ltd							
X. ° ±3° X. X° ±0.5°									
>0-3	>3-18	>18-50	>50-120	Unit	Scale	Design Unit	Size	Part No.	
±0.12	±0.15	±0.3	±0.5	mm	—	Metric	A4		
Draw	Review	Approve	Material	Drawing No.	Part No.				
				Item	5500-NY				

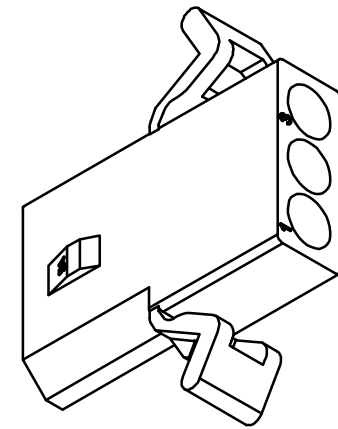
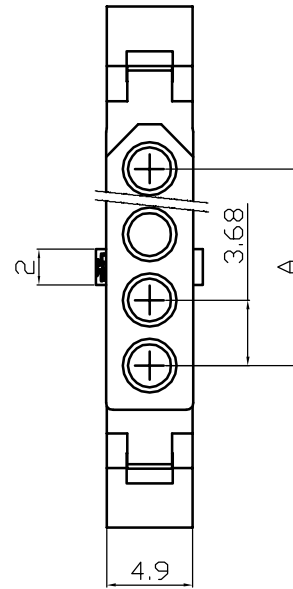
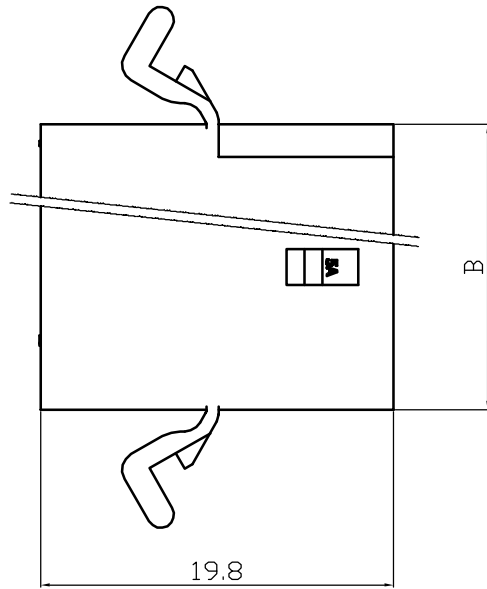
5500 Type Housing



Poles	Part No.		Dimensions	
			A	B
2	WW3681-HB02	5500B-2Y	3.68	8.64
3	WW3681-HB03	5500B-3Y	7.36	12.32
4	WW3681-HB04	5500B-4Y	11.04	16
5	WW3681-HB05	5500B-5Y	14.72	19.68

1	Housing	PA66(UL94V-0/V-2)	1	White					
No.	Item/Material No.	Material	QTY	Remark					
Unmarked Tolerance		 Yueqing Hegxing Electronics Co., Ltd							
X. ° ±3° X. X° ±0.5°									
>0-3	>3-18	>18-50	>50-120	Unit	Scale	Design Unit	Size	Part No.	 
±0.12	±0.15	±0.3	±0.5	mm	—	Metric	A4		
Draw	Review	Approve	Material	Drawing No.			Part No.		
				Item	5500B-NY				

5500 Type Housing

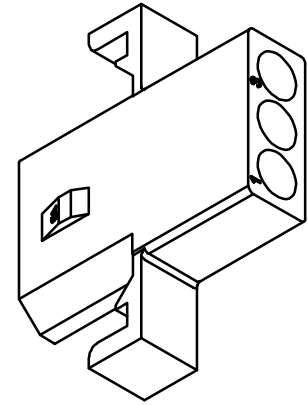
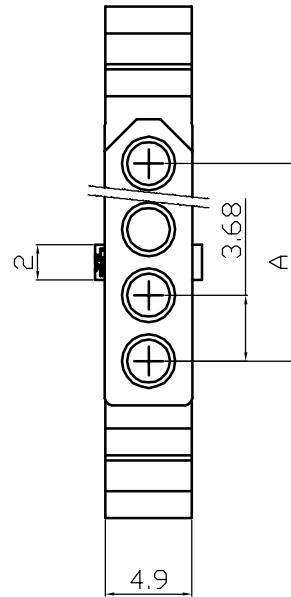
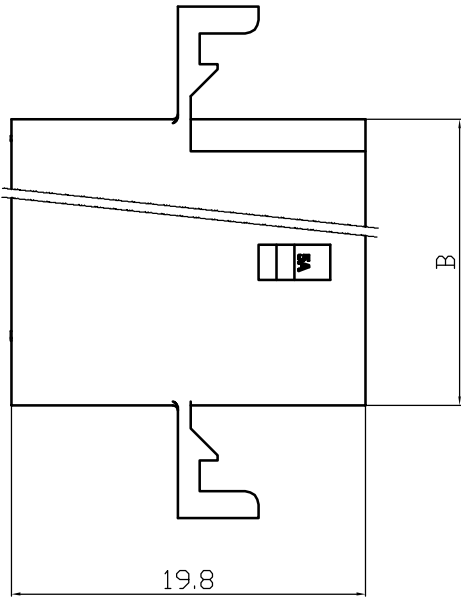

Poles	Part No.		Dimensions	
			A	B
2	WW3681-HC02	5500C-2Y	3.68	8.64
3	WW3681-HC03	5500C-3Y	7.36	12.32
4	WW3681-HC04	5500C-4Y	11.04	16
5	WW3681-HC05	5500C-5Y	14.72	19.68

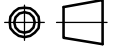
1	Housing	PA66(UL94V-0/V-2)	1	White					
No.	Item/Material No.	Material	QTY	Remark					
Unmarked Tolerance		 Yueqing Hegxing Electronics Co., Ltd							
X. ° ±3° X. X° ±0.5°									
>0-3	>3-18	>18-50	>50-120	Unit	Scale	Design Unit	Size	Part No.	
±0.12	±0.15	±0.3	±0.5	mm	—	Metric	A4		
Draw	Review	Approve	Material	Drawing No.	Part No.				
				Item	5500C-NY				

5500 Type Housing

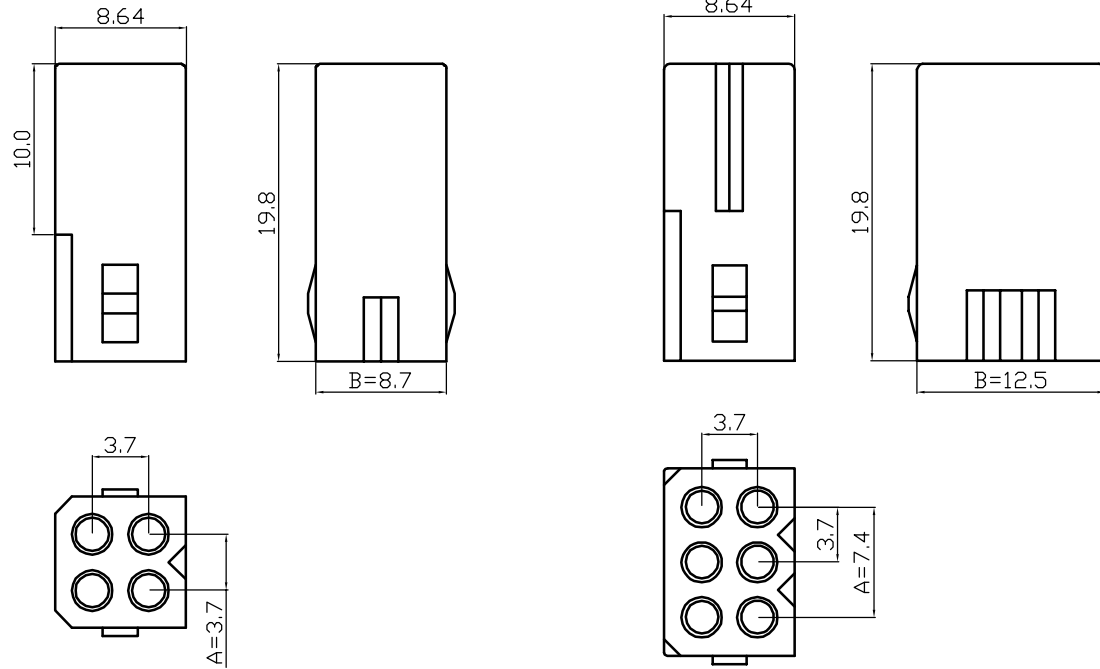

Poles	Part No.		Dimensions	
	A	B	A	B
4	WW3681-H02x2	5500-2x2Y	3.7	8.7
6	WW3681-H03x2	5500-2x3Y	7.4	12.5

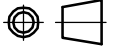
1	Housing	PA66(UL94V-0/V-2)	1	White					
No.	Item/Material No.	Material	QTY	Remark					
Unmarked Tolerance		 Yueqing Hegxing Electronics Co., Ltd							
X. ° ±3°	X. X ° ±0.5°								
>0-3	>3-18	>18-50	>50-120	Unit	Scale	Design Unit	Size	Part No.	
±0.12	±0.15	±0.3	±0.5	mm	—	Metric	A4		
Draw	Review	Approve	Material	Drawing No.	Part No.				
				Item	5500-2xNY-96				

5500 Type Housing

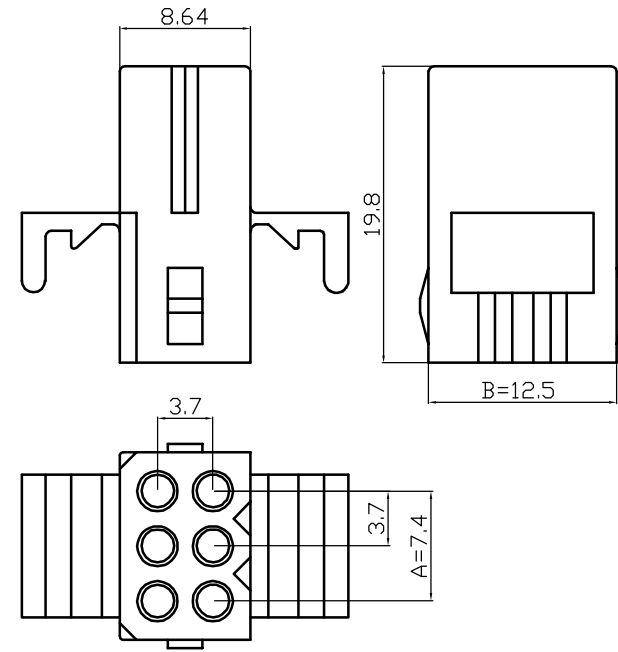
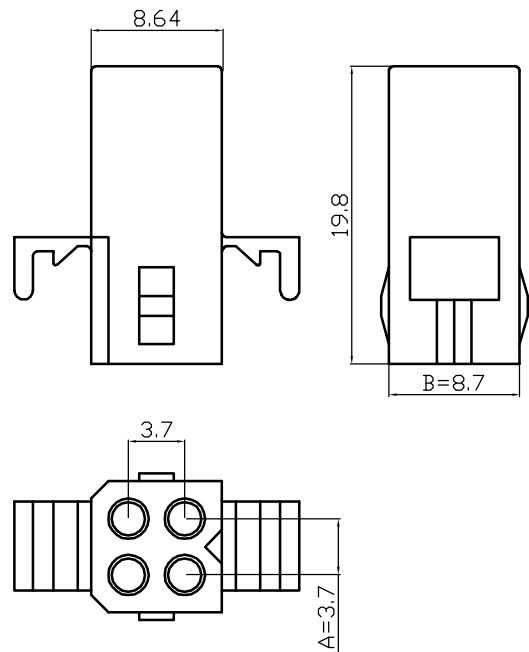

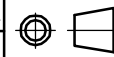

Poles	Part No.		Dimensions	
			A	B
4	WW3681-HC02x2	5500C-2x2Y	3.7	8.7
6	WW3681-HC03x2	5500C-2x3Y	7.4	12.5

1	Housing	PA66(UL94V-0/V-2)	1	White					
No.	Item/Material No.	Material	QTY	Remark					
Unmarked Tolerance		 Yueqing Hegxing Electronics Co., Ltd							
X. ° ±3° X. X° ±0.5°									
>0-3	>3-18	>18-50	>50-120	Unit	Scale	Design Unit	Size	Part No.	
±0.12	±0.15	±0.3	±0.5	mm	—	Metric	A4		
Draw	Review	Approve	Material	Drawing No.	Part No.				
				Item	5500C-2xNY-96				

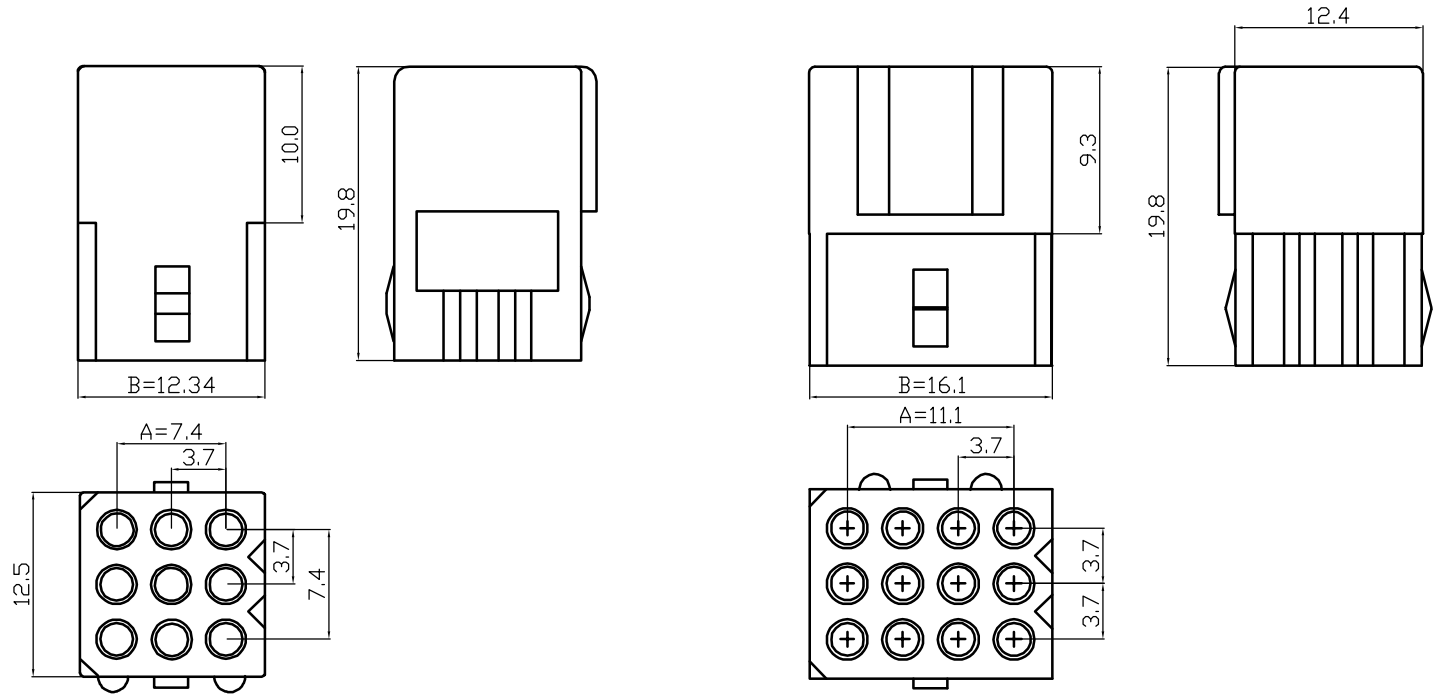
5500 Type Housing





Poles	Part No.		Dimensions	
			A	B
9	WW3681-H03x3	5500-3x2Y	7.4	12.34
12	WW3681-H03x3	5500-3x3Y	11.1	16.1

1	Housing	PA66(UL94V-0/V-2)	1	White					
No.	Item/Material No.	Material	QTY	Remark					
Unmarked Tolerance		 Yueqing Hegxing Electronics Co., Ltd							
X. ° ±3° X. X° ±0.5°									
>0-3	>3-18	>18-50	>50-120	Unit	Scale	Design Unit	Size	Part No.	 
±0.12	±0.15	±0.3	±0.5	mm	—	Metric	A4		
Draw	Review	Approve	Material	Drawing No.	Part No.				
				Item	5500-2xNY				

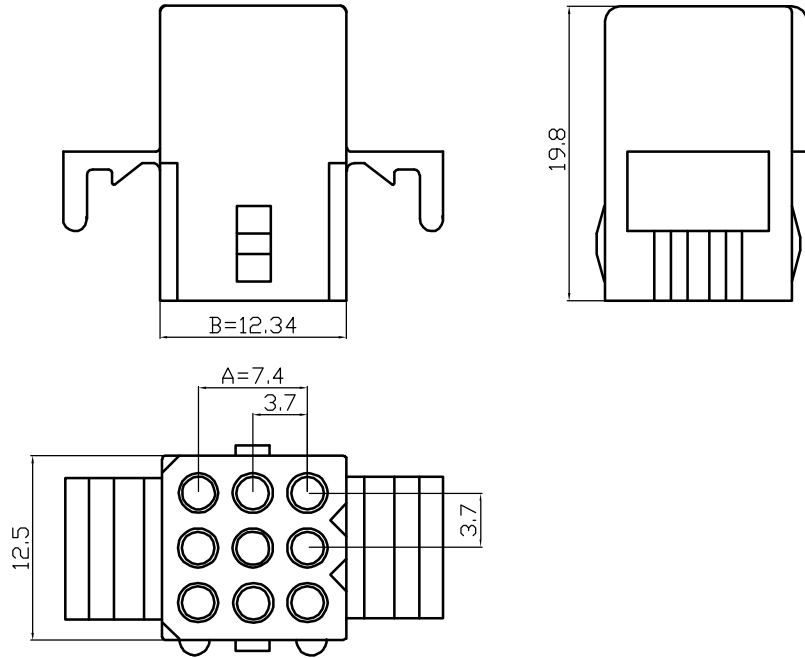
5500 Type Housing



Poles	Part No.	Dimensions	
		A	B
9	WW3681-HC03x3 5500-3x3Y	7.4	12.34

1	Housing	PA66(UL94V-0/V-2)	1	White					
No.	Item/Material No.	Material	QTY	Remark					
Unmarked Tolerance		 Yueqing Hegxing Electronics Co., Ltd							
X. ° ±3° X. X° ±0.5°									
>0-3	>3-18	>18-50	>50-120	Unit	Scale	Design Unit	Size	Part No.	 
±0.12	±0.15	±0.3	±0.5	mm	—	Metric	A4		
Draw	Review	Approve	Material	Drawing No.	Part No.				
			Item	5500-3x3Y-96					

5500 Type Terminal

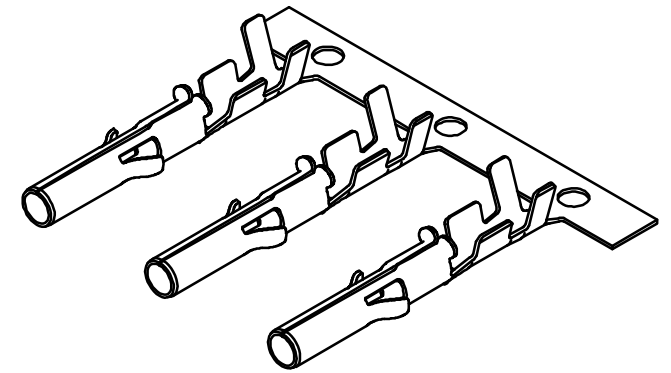
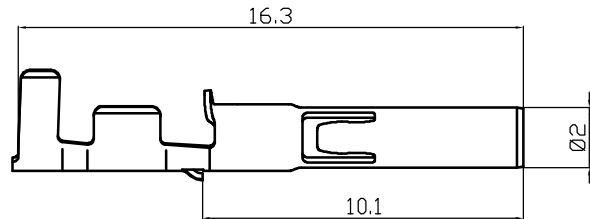
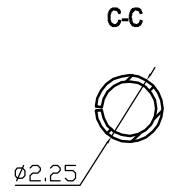
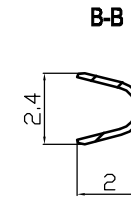
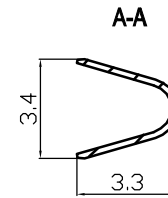
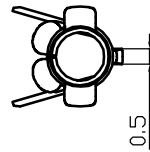
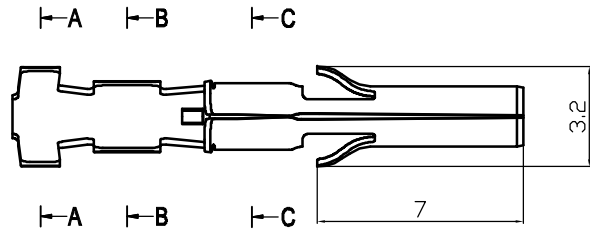

1	Terminal	Phospher Bronze	1	
No.	Item/Material No.	Material	QTY	Remark
Unmarked Tolerance		 Yueqing Hegxing Electronics Co., Ltd		
X. ° ±3° X. X° ±0.5°				
>0-3	>3-18	>18-50	>50-120	
±0.12	±0.15	±0.3	±0.5	
Unit	Scale	Design Unit	Size	Part No.
mm	—	Metric	A4	
Draw	Review	Approve	Material	Drawing No.
			Item	5500-YT



5600 Type Housing

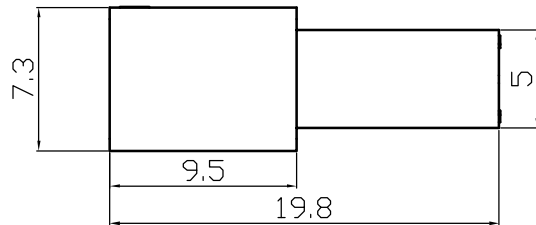
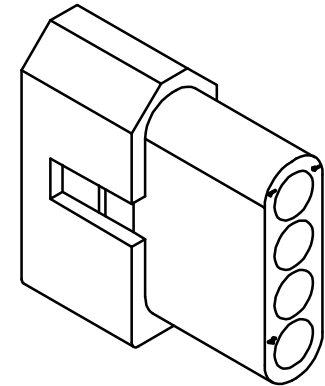
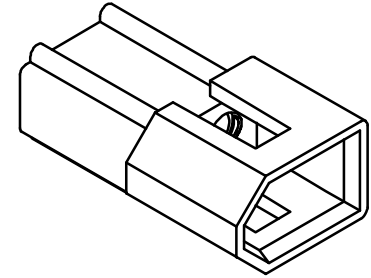
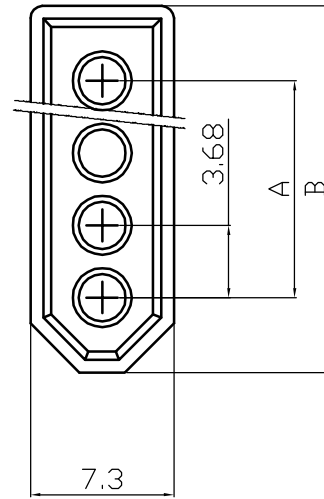
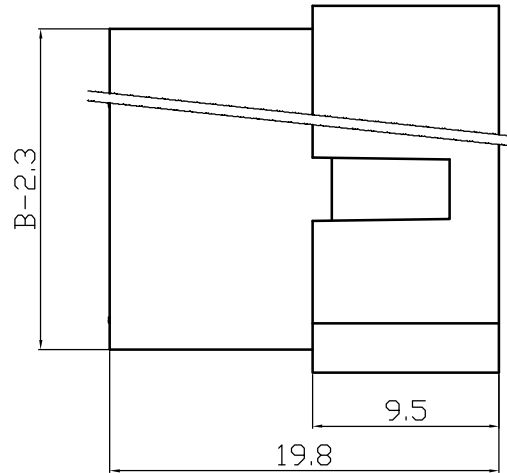



Poles	Part No.		Dimensions	
			A	B
2	WW3682-H02	5600-2A	3.68	11.28
3	WW3682-H03	5600-3A	7.36	14.96
4	WW3682-H04	5600-4A	11.04	18.64
5	WW3682-H05	5600-5A	14.72	22.32

1	Housing	PA66(UL94V-0/V-2)	1	White
No.	Item/Material No.	Material	QTY	Remark
Unmarked Tolerance		 Yueqing Hegxing Electronics Co., Ltd		
X. ° ±3° X. X° ±0.5°				
>0-3	>3-18	>18-50	>50-120	
±0.12	±0.15	±0.3	±0.5	
Unit	Scale	Design Unit	Size	Part No.
mm	—	Metric	A4	
Draw	Review	Approve	Material	Drawing No.
				Part No.
			Item	5600-NA

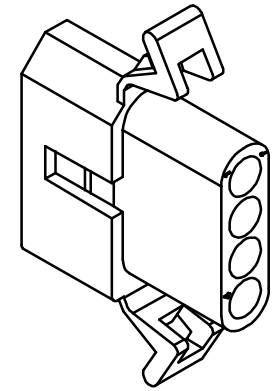
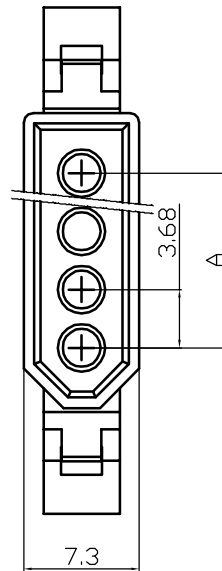
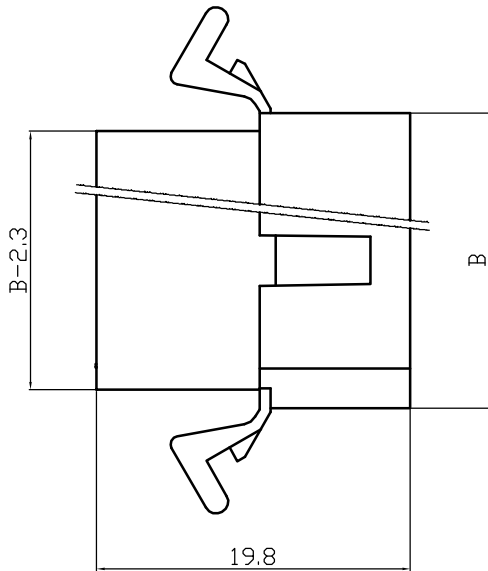
5600 Type Housing



Poles	Part No.		Dimensions	
			A	B
2	WW3682-HB02	5600B-2A	3.68	11.28
3	WW3682-HB03	5600B-3A	7.36	14.96
4	WW3682-HB04	5600B-4A	11.04	18.64
5	WW3682-HB05	5600B-5A	14.72	22.32

1	Housing	PA66(UL94V-0/V-2)	1	White					
No.	Item/Material No.	Material	QTY	Remark					
Unmarked Tolerance		 Yueqing Hegxing Electronics Co., Ltd							
X. ° ±3° X. X° ±0.5°									
>0-3	>3-18	>18-50	>50-120	Unit	Scale	Design Unit	Size	Part No.	 
±0.12	±0.15	±0.3	±0.5	mm	—	Metric	A4		
Draw	Review	Approve	Material	Drawing No.			Part No.		
				Item	5600B-NA				

5600 Type Housing

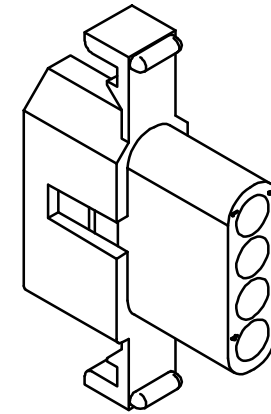
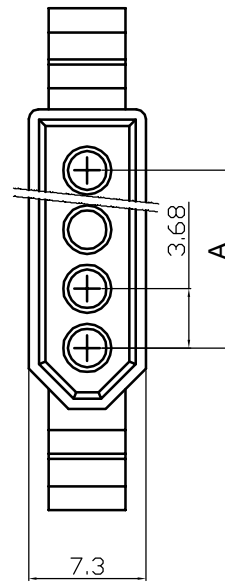
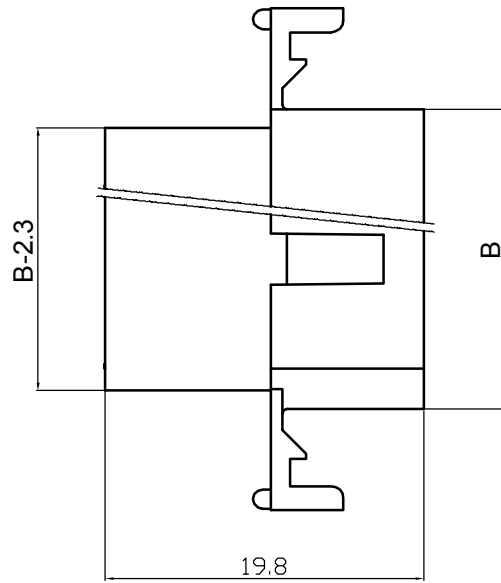

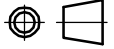

Poles	Part No.		Dimensions	
			A	B
2	WW3682-HC02	5600C-2A	3.68	11.28
3	WW3682-HC03	5600C-3A	7.36	14.96
4	WW3682-HC04	5600C-4A	11.04	18.64
5	WW3682-HC05	5600C-5A	14.72	22.32

1	Housing	PA66(UL94V-0/V-2)	1	White					
No.	Item/Material No.	Material	QTY	Remark					
Unmarked Tolerance		 Yueqing Hegxing Electronics Co., Ltd							
X. ° ±3° X. X° ±0.5°									
>0-3	>3-18	>18-50	>50-120	Unit	Scale	Design Unit	Size	Part No.	
±0.12	±0.15	±0.3	±0.5	mm	—	Metric	A4		
Draw	Review	Approve	Material	Drawing No.			Part No.		
				Item	5600C-NA				

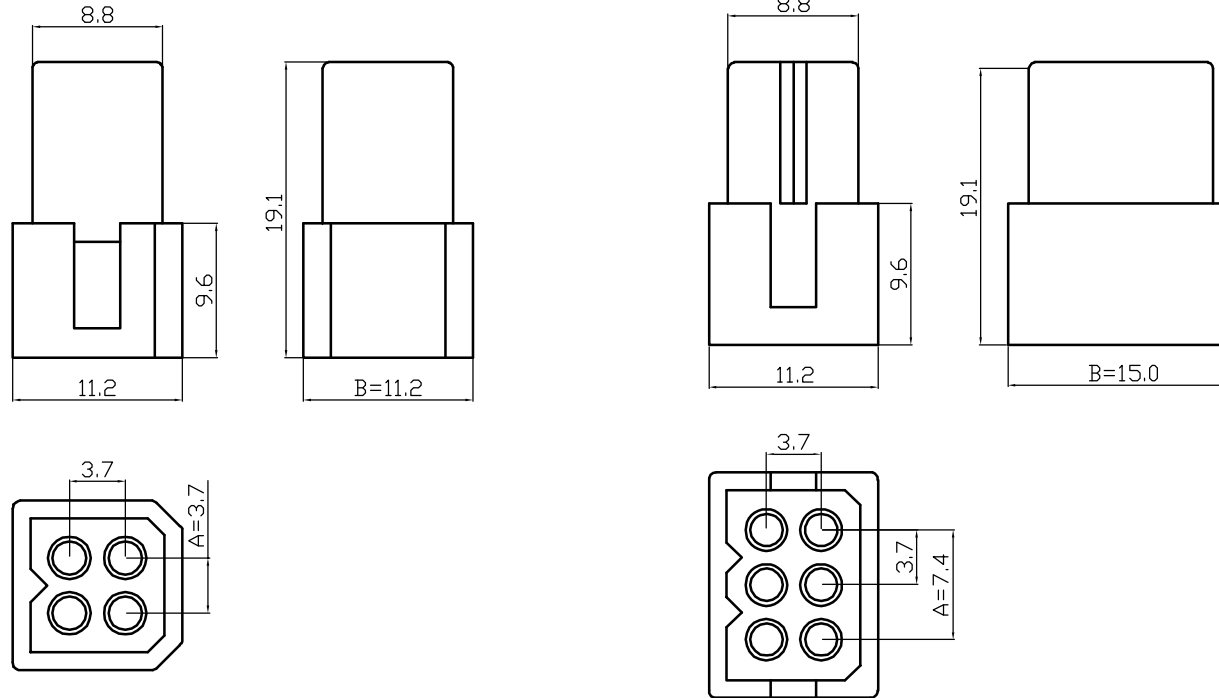
5600 Type Housing





Poles	Part No.		Dimensions	
			A	B
4	WW3682-H02x2	5600-2x2A	3.7	11.2
6	WW3682-H03x2	5600-2x3A	7.4	15

1	Housing	PA66(UL94V-0/V-2)	1	White					
No.	Item/Material No.	Material	QTY	Remark					
Unmarked Tolerance		 Yueqing Hegxing Electronics Co., Ltd							
X. ° ±3° X. X° ±0.5°									
>0-3	>3-18	>18-50	>50-120	Unit	Scale	Design Unit	Size	Part No.	 
±0.12	±0.15	±0.3	±0.5	mm	—	Metric	A4		
Draw	Review	Approve	Material	Drawing No.	Part No.				
				Item	5600-2xNA-96				

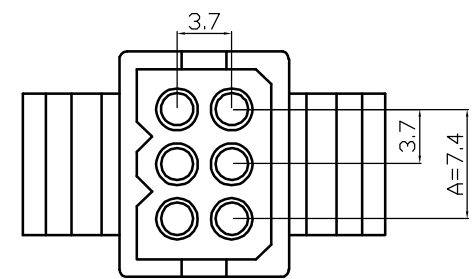
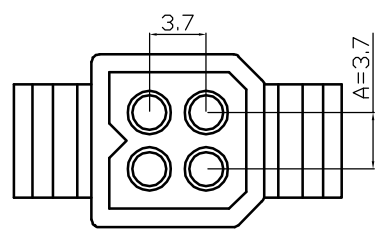
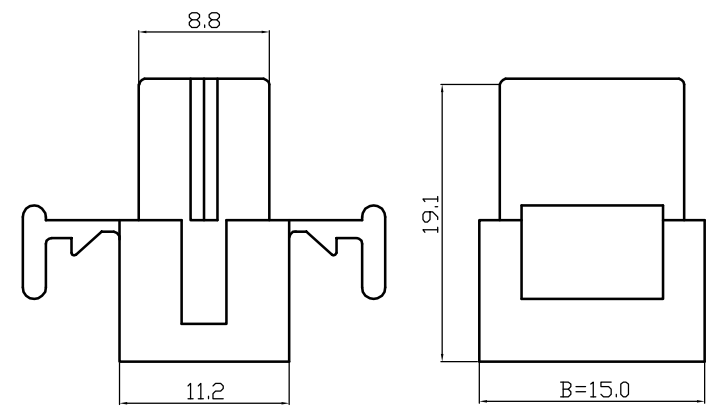
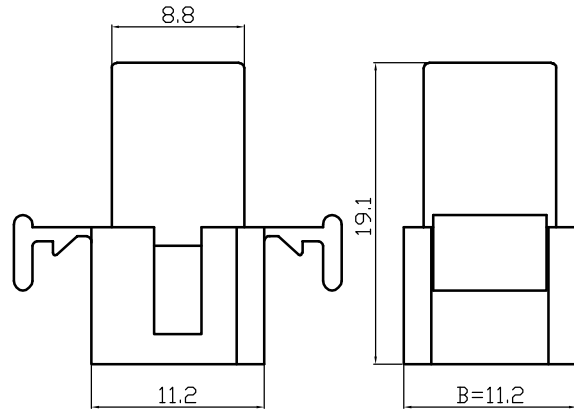
5600 Type Housing



Poles	Part No.		Dimensions	
			A	B
4	WW3682-HC02x2	5600C-2x2A	3.7	11.2
6	WW3682-HC03x2	5600C-2x3A	7.4	15

1	Housing	PA66(UL94V-0/V-2)	1	White					
No.	Item/Material No.	Material	QTY	Remark					
Unmarked Tolerance		 Yueqing Hegxing Electronics Co., Ltd							
X. ° ±3°	X. X° ±0.5°								
>0-3	>3-18	>18-50	>50-120	Unit	Scale	Design Unit	Size	Part No.	 
±0.12	±0.15	±0.3	±0.5	mm	—	Metric	A4		
Draw	Review	Approve	Material	Drawing No.	Part No.				
				Item	5600C-2xNA-96				

5600 Type Housing

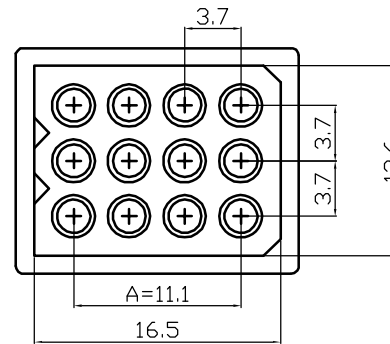
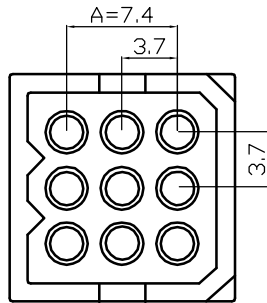
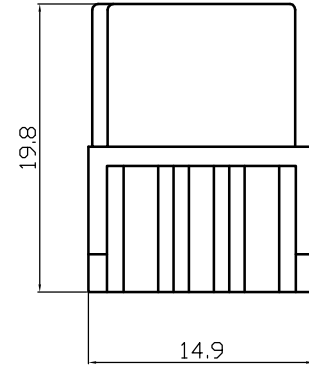
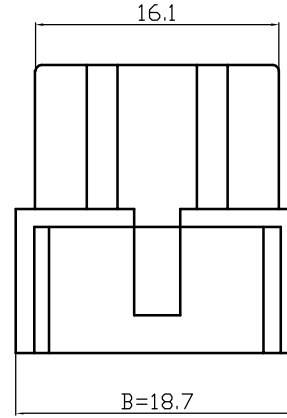
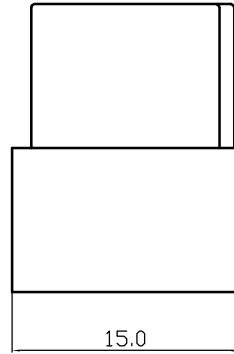
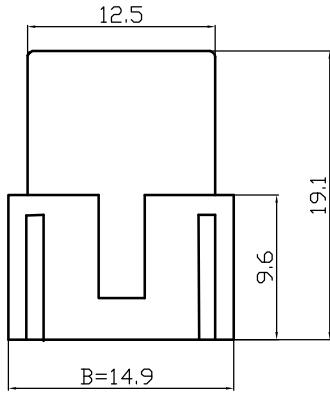

Poles	Part No.		Dimensions	
			A	B
9	WW3682-H03x3	5600-3x3A	7.4	14.9
12	WW3682-H04x3	5600-3x4A	11.1	18.7

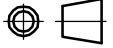
1	Housing	PA66(UL94V-0/V-2)	1	White					
No.	Item/Material No.	Material	QTY	Remark					
Unmarked Tolerance		 Yueqing Hegxing Electronics Co., Ltd							
X. ° ±3° X. X° ±0.5°									
>0-3	>3-18	>18-50	>50-120	Unit	Scale	Design Unit	Size	Part No.	
±0.12	±0.15	±0.3	±0.5	mm	—	Metric	A4		
Draw	Review	Approve	Material	Drawing No.	Part No.				
				Item	5600-3xNA				

5600 Type Housing

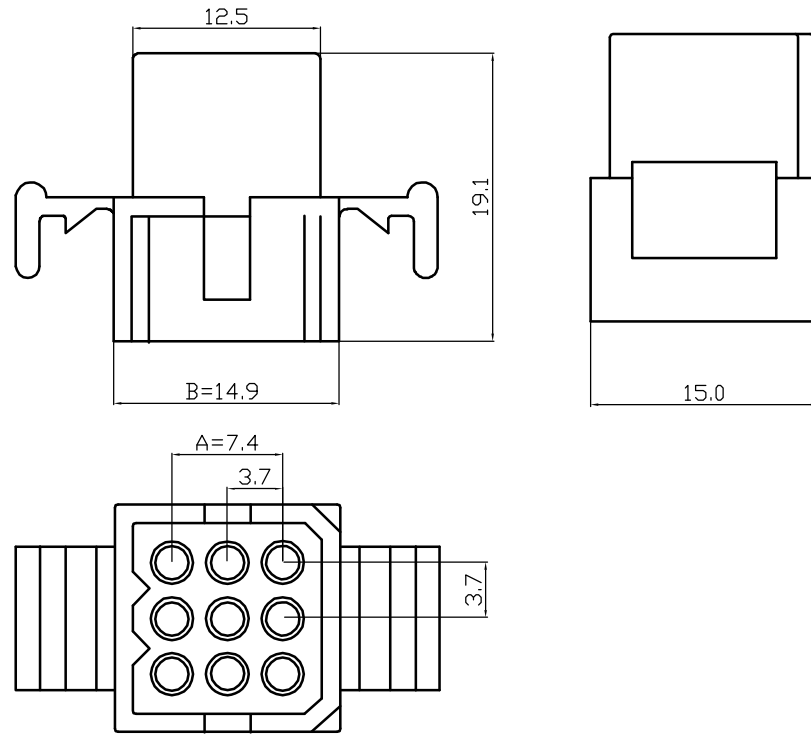

Poles	Part No.		Dimensions	
			A	B
9	WW3682-HC03x3	5600C-3x3A	7.4	12.34

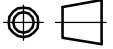
1	Housing	PA66(UL94V-0/V-2)	1	White					
No.	Item/Material No.	Material	QTY	Remark					
Unmarked Tolerance		 Yueqing Hegxing Electronics Co., Ltd							
X. ° ±3° X. X° ±0.5°									
>0-3	>3-18	>18-50	>50-120	Unit	Scale	Design Unit	Size	Part No.	
±0.12	±0.15	±0.3	±0.5	mm	—	Metric	A4		
Draw	Review	Approve	Material	Drawing No.	Part No.				
			Item	5600C-3x3A					

5600 Type Terminal

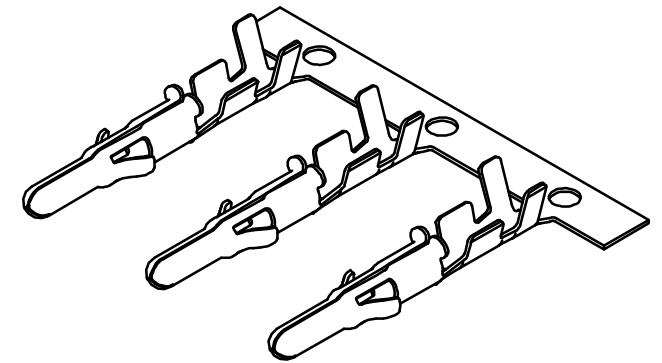
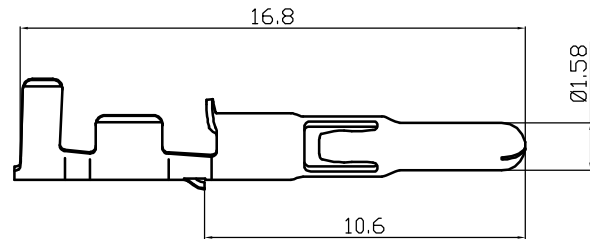
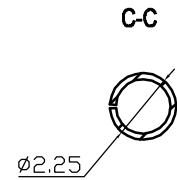
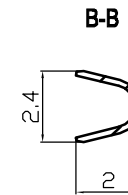
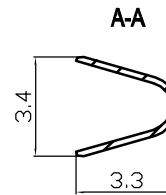
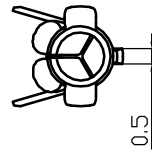
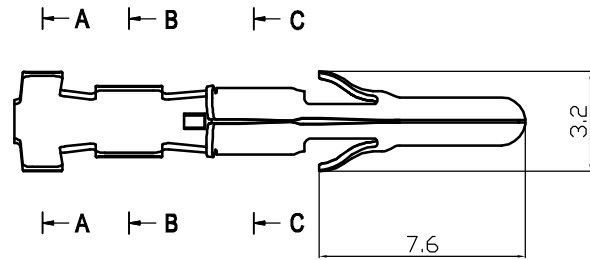

1	Terminal	Phospher Bronze	1	
No.	Item/Material No.	Material	QTY	Remark
Unmarked Tolerance		 Yueqing Hegxing Electronics Co., Ltd		
X. ° ±3° X. X° ±0.5°				
>0-3	>3-18	>18-50	>50-120	Unit
±0.12	±0.15	±0.3	±0.5	mm
Draw	Review	Approve	Material	Scale
			Drawing No.	Design Unit
			Item	Size
				Part No.
				Part No.
				A4
				mm
				Metric
				A4
				Part No.
				Part No.
				5600-AT