

Small EL Type Housing

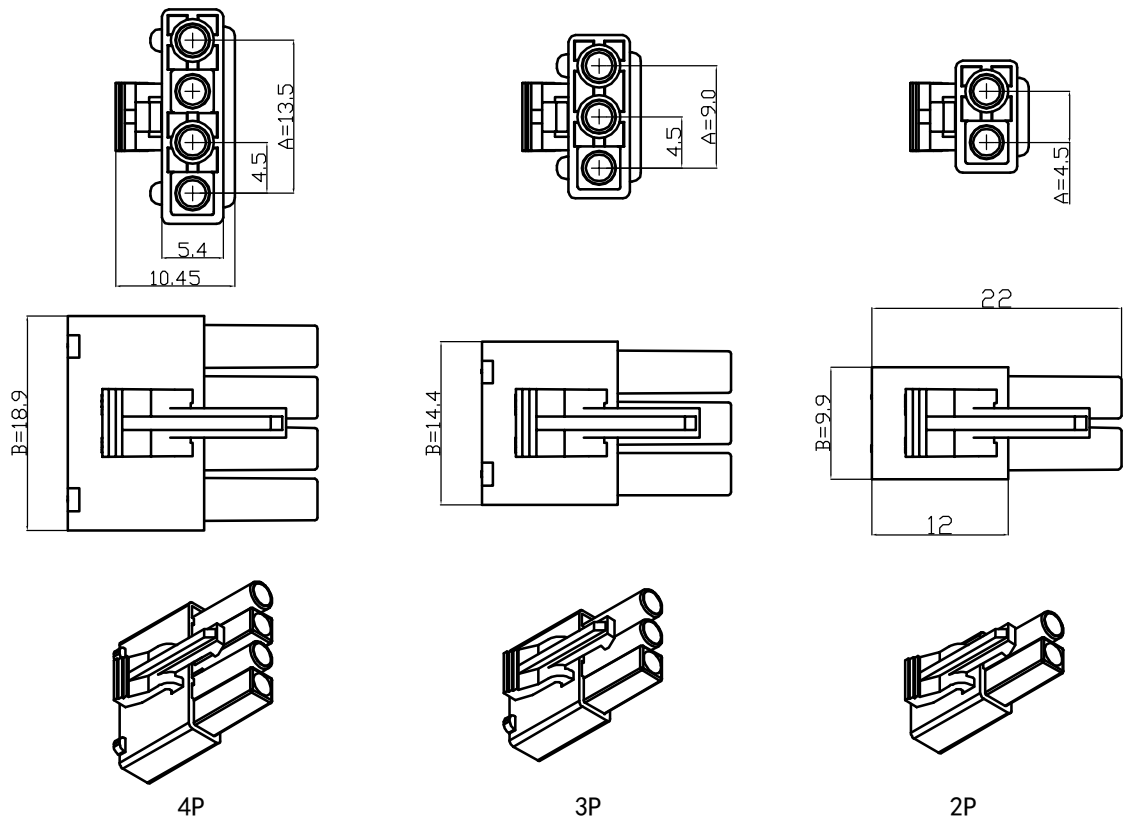

Poles	Part No.		Dimensions	
			A	B
2	WW4503-H02	Small EL-2Y	4.5	9.9
3	WW4503-H03	Small EL-3Y	9	14.4
4	WW4503-H04	Small EL-4Y	13.5	18.9

1	Housing	PA66(UL94V-0/V-2)	1	White					
No.	Item/Material No.	Material	QTY	Remark					
Unmarked Tolerance		Yueqing Hegxing Electronics Co., Ltd							
X. ° ±3° X. X° ±0.5°									
>0-3	>3-18	>18-50	>50-120	Unit	Scale	Design Unit	Size	Part No.	
±0.12	±0.15	±0.3	±0.5	mm	—	Metric	A4		
Draw	Review	Approve	Material	Drawing No.	Part No.				
				Item	Small EL-NY				

Small EL Type Terminal

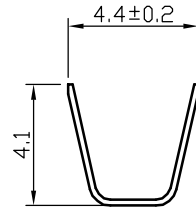
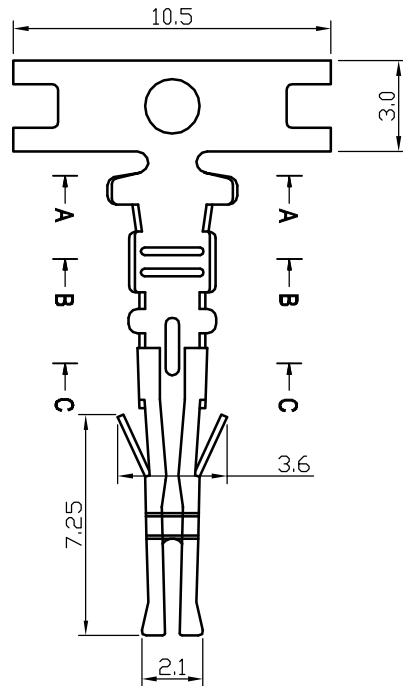
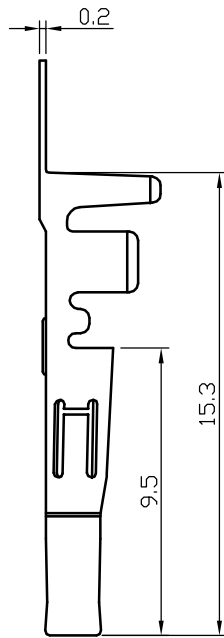

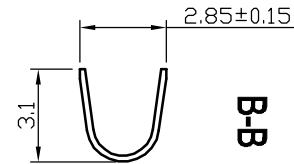

A-A

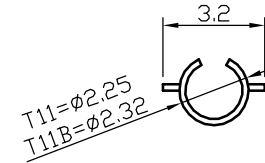

B-B



C-C

1	Terminal	Phosphor Bronze	1	
No.	Item/Material No.	Material	QTY	Remark
Unmarked Tolerance		 Yueqing Hegxing Electronics Co., Ltd		
X. ° ±3° X. X° ±0.5°				
>0-3	>3-18	>18-50	>50-120	Unit
±0.12	±0.15	±0.3	±0.5	mm
Design Unit	Scale	Size	Part No.	 
	—	Metric	A4	
Draw	Review	Approve	Material	Drawing No.
			Item	Small EL-YT

Small EL Type Housing

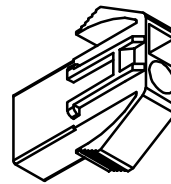
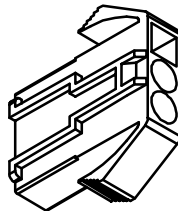
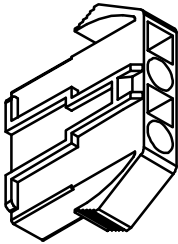
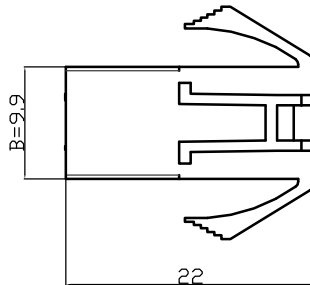
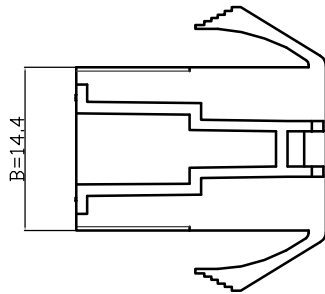
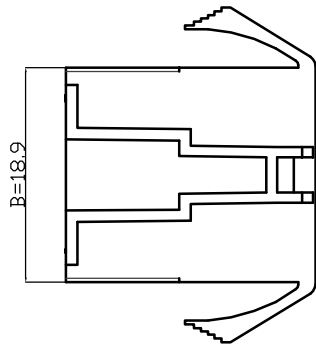
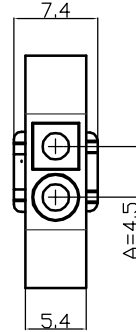
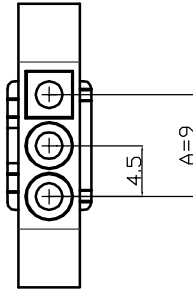
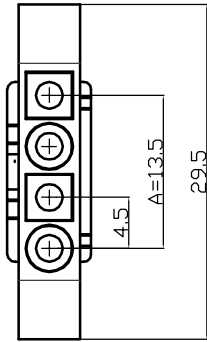



4P

3P

2P

Poles	Part No.		Dimensions	
			A	B
2	WW4504-H02	Small EL-2A	4.5	9.9
3	WW4504-H03	Small EL-3A	9	14.4
4	WW4504-H04	Small EL-4A	13.5	18.9

1	Housing	PA66(UL94V-0/V-2)	1	White					
No.	Item/Material No.	Material	QTY	Remark					
Unmarked Tolerance		 Yueqing Hegxing Electronics Co., Ltd							
X. ° ±3° X. X° ±0.5°									
>0-3	>3-18	>18-50	>50-120	Unit	Scale	Design Unit	Size	Part No.	 
±0.12	±0.15	±0.3	±0.5	mm	—	Metric	A4		
Draw	Review	Approve	Material	Drawing No.	Part No.				
				Item	Small EL-NA				

Small EL Type Housing

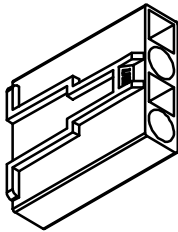
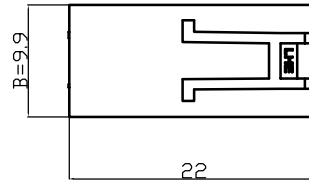
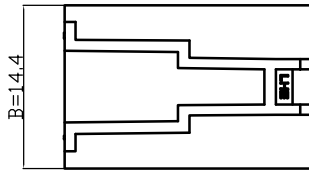
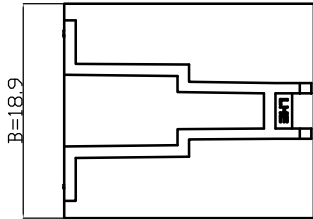
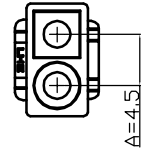
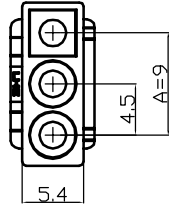
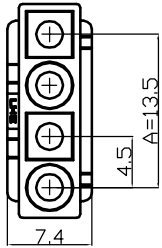

4P

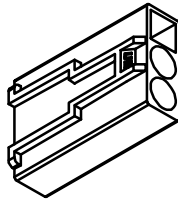

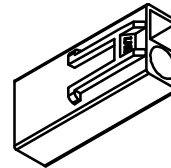

3P



2P

Poles	Part No.		Dimensions	
			A	B
2	WW4504-HB02	Small EL-2AF	4.5	9.9
3	WW4504-HB03	Small EL-3AF	9	14.4
4	WW4504-HB04	Small EL-4AF	13.5	18.9

1	Housing	PA66(UL94V-0/V-2)	1	White					
No.	Item/Material No.	Material	QTY	Remark					
Unmarked Tolerance		 Yueqing Hegxing Electronics Co., Ltd							
X. ° ±3° X. X° ±0.5°									
>0-3	>3-18	>18-50	>50-120	Unit	Scale	Design Unit	Size	Part No.	 
±0.12	±0.15	±0.3	±0.5	mm	—	Metric	A4		
Draw	Review	Approve	Material	Drawing No.	Part No.				
				Item	Small EL-NY				

Small EL Type Terminal

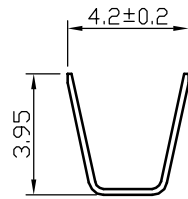
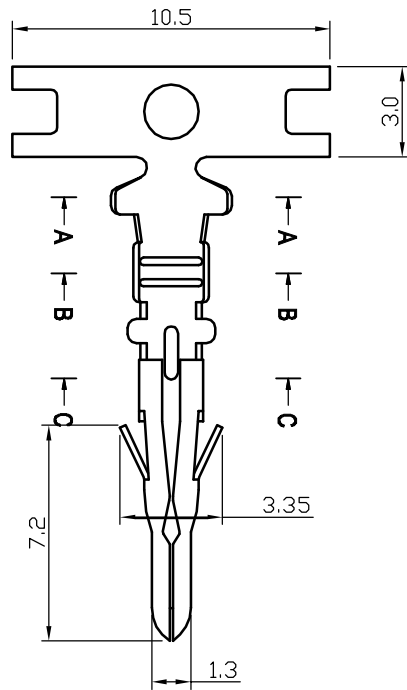
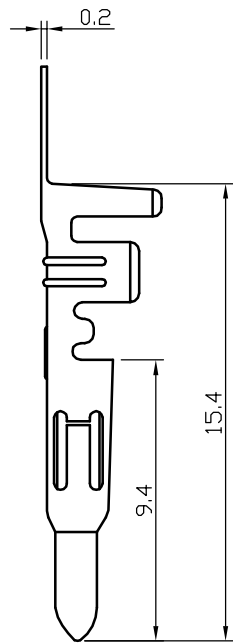

A-A

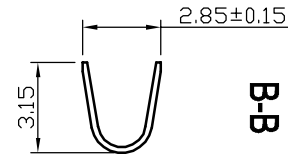

B-B

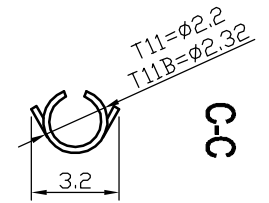

C-C

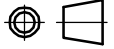
1	Terminal	Phospher Bronze	1	
No.	Item/Material No.	Material	QTY	Remark
Unmarked Tolerance		 Yueqing Hegxing Electronics Co., Ltd		
X. ° ±3° X. X° ±0.5°				
>0-3	>3-18	>18-50	>50-120	Unit
±0.12	±0.15	±0.3	±0.5	mm
Scale	Design Unit	Size	Part No.	
—	Metric	A4		
Draw	Review	Approve	Material	Drawing No.
			Item	Small EL-AT