

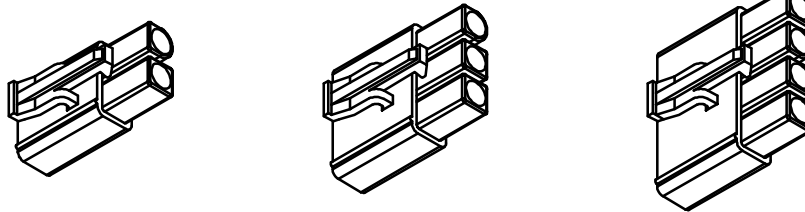

L6.2 Type Housing

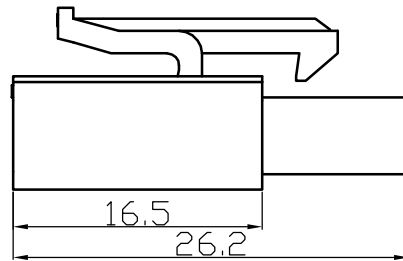

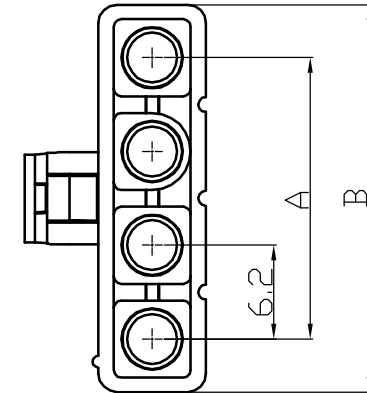
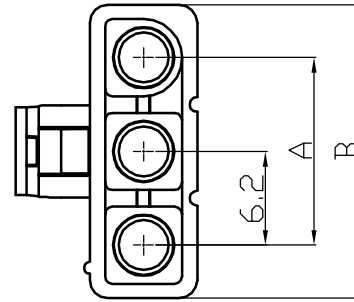
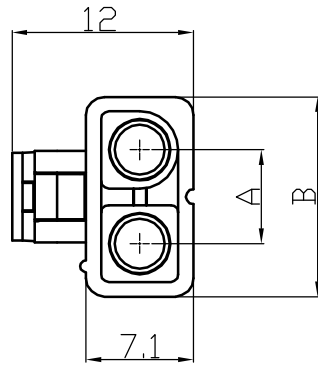

| Poles | Part No. | | Dimensions | |
|-------|------------|---------|------------|------|
| | A | B | A | B |
| 2 | WW6201-H02 | L6.2-2Y | 4.5 | 9.9 |
| 3 | WW6201-H03 | L6.2-3Y | 9 | 14.4 |
| 4 | WW6201-H04 | L6.2-4Y | 13.5 | 18.9 |

| 1 | Housing | PA66(UL94V-0/V-2) | 1 | White |
|----------------------|-------------------|--|----------|-------------|
| No. | Item/Material No. | Material | QTY | Remark |
| Unmarked Tolerance | |  Yueqing Hegxing Electronics Co., Ltd | | |
| X. ° ±3° X. X° ±0.5° | | | | |
| >0-3 | >3-18 | >18-50 | >50-120 | |
| ±0.12 | ±0.15 | ±0.3 | ±0.5 | |
| Unit | Scale | Design Unit | Size | Part No. |
| mm | — | Metric | A4 | |
| Draw | Review | Approve | Material | Drawing No. |
| | | | | Part No. |
| | | | Item | L6.2-NY |

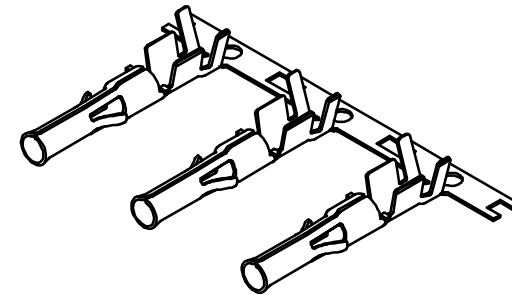
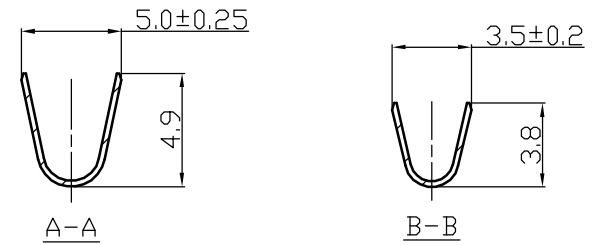
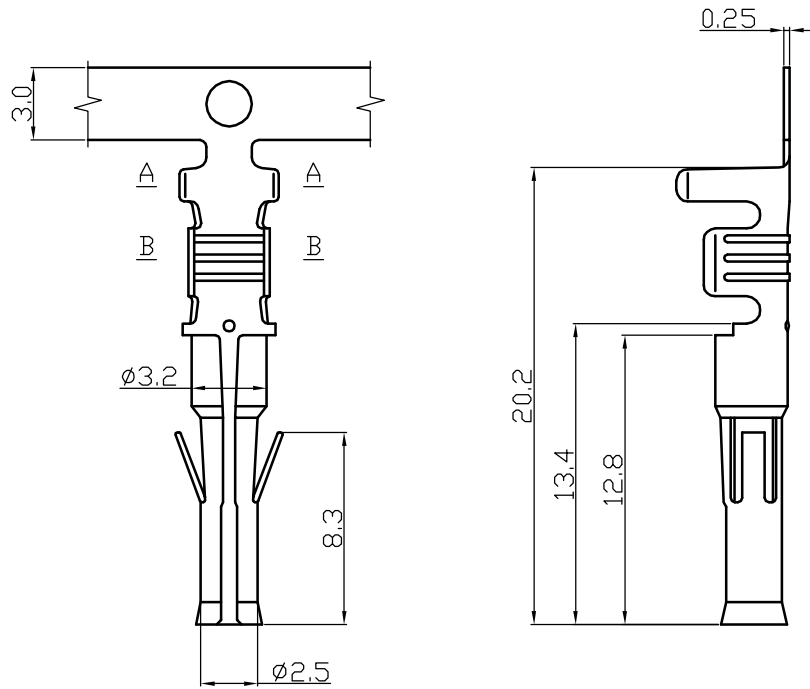
L6.2 Type Terminal





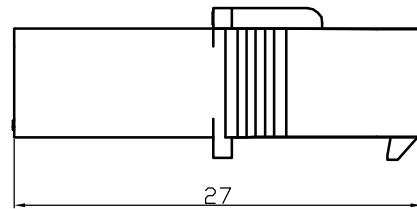
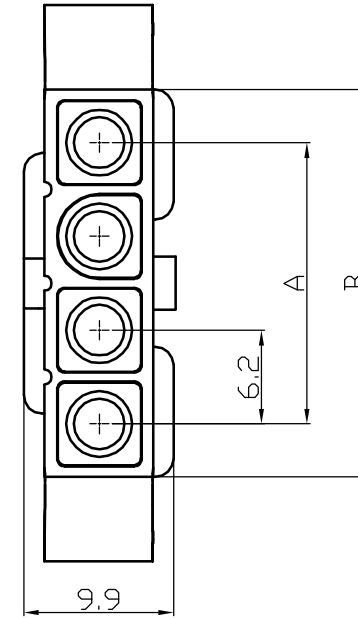
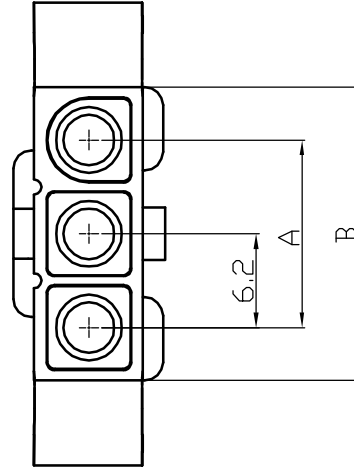
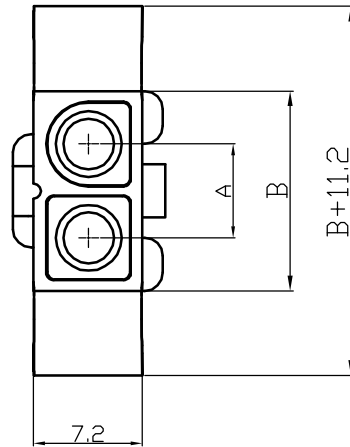

| 1 | Terminal | Phospher Bronze | 1 | | | | | | |
|----------------------|-------------------|--|----------|-------------|---------|-------------|----------|----------|---|
| No. | Item/Material No. | Material | QTY | Remark | | | | | |
| Unmarked Tolerance | |  Yueqing Hegxing Electronics Co., Ltd | | | | | | | |
| X. ° ±3° X. X° ±0.5° | | | | | | | | | |
| >0-3 | >3-18 | >18-50 | >50-120 | Unit | Scale | Design Unit | Size | Part No. |   |
| ±0.12 | ±0.15 | ±0.3 | ±0.5 | mm | — | Metric | A4 | | |
| Draw | Review | Approve | Material | Drawing No. | | | Part No. | | |
| | | | | Item | L6.2-YT | | | | |

L6.2 Type Housing

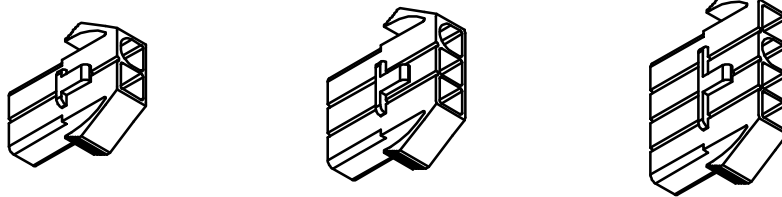

| Poles | Part No. | | Dimensions | |
|-------|------------|---------|------------|------|
| | A | B | A | B |
| 2 | WW6202-H02 | L6.2-2A | 6.2 | 13.2 |
| 3 | WW6202-H03 | L6.2-3A | 12.4 | 19.4 |
| 4 | WW6202-H04 | L6.2-4A | 18.6 | 25.6 |



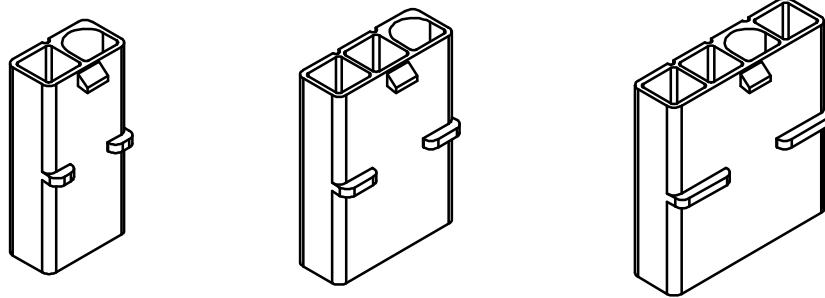
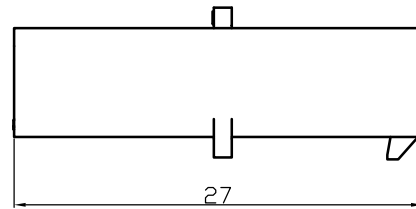
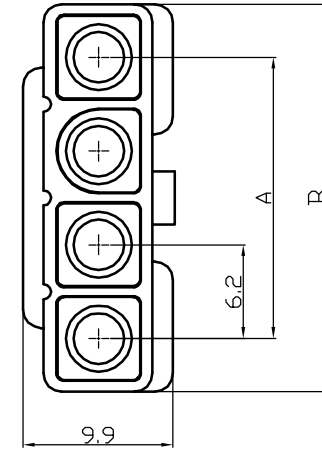
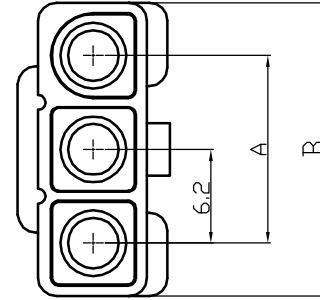
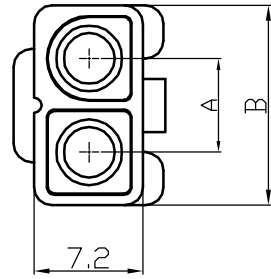

| | | | | | | | | | |
|----------------------|-------------------|--|----------|-------------|----------|-------------|------|----------|---|
| 1 | Housing | PA66(UL94V-0/V-2) | 1 | White | | | | | |
| No. | Item/Material No. | Material | QTY | Remark | | | | | |
| Unmarked Tolerance | |  Yueqing Hegxing Electronics Co., Ltd | | | | | | | |
| X. ° ±3° X. X° ±0.5° | | | | | | | | | |
| >0-3 | >3-18 | >18-50 | >50-120 | Unit | Scale | Design Unit | Size | Part No. |   |
| ±0.12 | ±0.15 | ±0.3 | ±0.5 | mm | — | Metric | A4 | | |
| Draw | Review | Approve | Material | Drawing No. | Part No. | | | | |
| | | | | Item | L6.2-NA | | | | |

L6.2 Type Housing



| Poles | Part No. | | Dimensions | |
|-------|-------------|----------|------------|------|
| | | | A | B |
| 2 | WW6202-HB02 | L6.2-2AF | 6.2 | 13.2 |
| 3 | WW6202-HB03 | L6.2-3AF | 12.4 | 19.4 |
| 4 | WW6202-HB04 | L6.2-4AF | 18.6 | 25.6 |

| 1 | Housing | PA66(UL94V-0/V-2) | 1 | White | | | | | |
|----------------------|-------------------|--|----------|-------------|----------|-------------|------|----------|---|
| No. | Item/Material No. | Material | QTY | Remark | | | | | |
| Unmarked Tolerance | |  Yueqing Hegxing Electronics Co., Ltd | | | | | | | |
| X. ° ±3° X. X° ±0.5° | | | | | | | | | |
| >0-3 | >3-18 | >18-50 | >50-120 | Unit | Scale | Design Unit | Size | Part No. |   |
| ±0.12 | ±0.15 | ±0.3 | ±0.5 | mm | — | Metric | A4 | | |
| Draw | Review | Approve | Material | Drawing No. | Part No. | | | | |
| | | | | Item | L6.2-NAF | | | | |

L6.2 Type Terminal

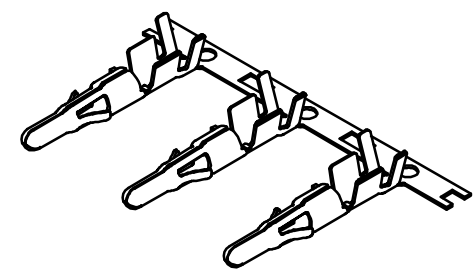
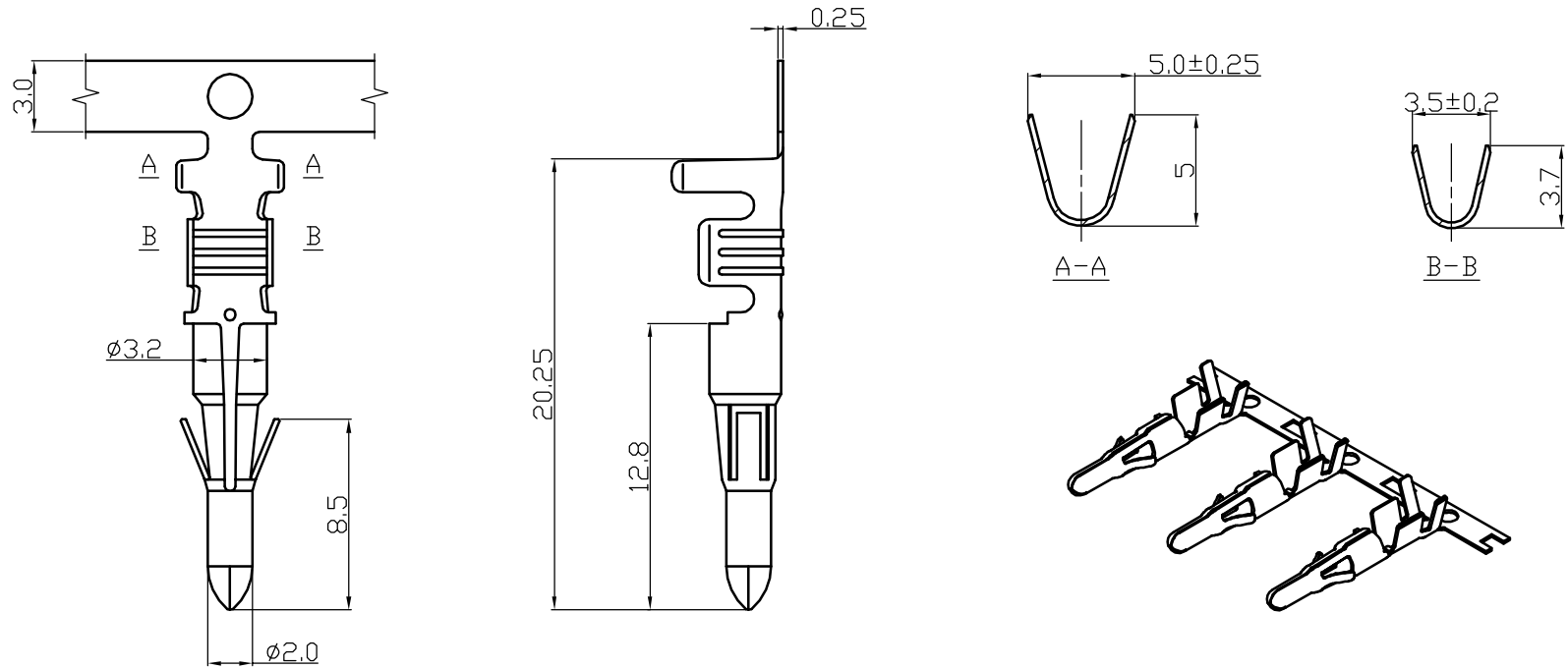

| 1 | Terminal | Phospher Bronze | 1 | |
|----------------------|-------------------|--|----------|----------|
| No. | Item/Material No. | Material | QTY | Remark |
| Unmarked Tolerance | |  Yueqing Hegxing Electronics Co., Ltd | | |
| X. ° ±3° X. X° ±0.5° | | | | |
| >0-3 | >3-18 | >18-50 | >50-120 | |
| ±0.12 | ±0.15 | ±0.3 | ±0.5 | |
| Unit | Scale | Design Unit | Size | Part No. |
| mm | — | Metric | A4 | |
| Draw | Review | Approve | Material | Part No. |
| | | | Item | L6.2-AT |