

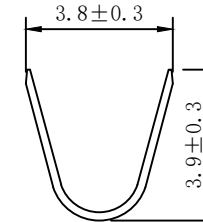

REVISIONS

P	LTR	DESCRIPTION	DATE	DWN	APVD

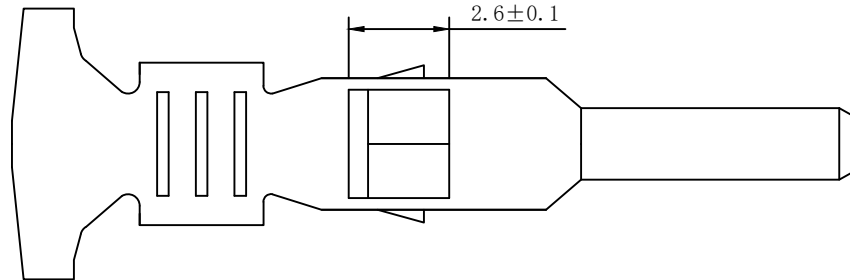
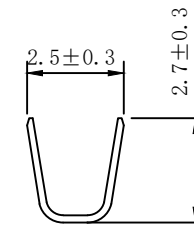
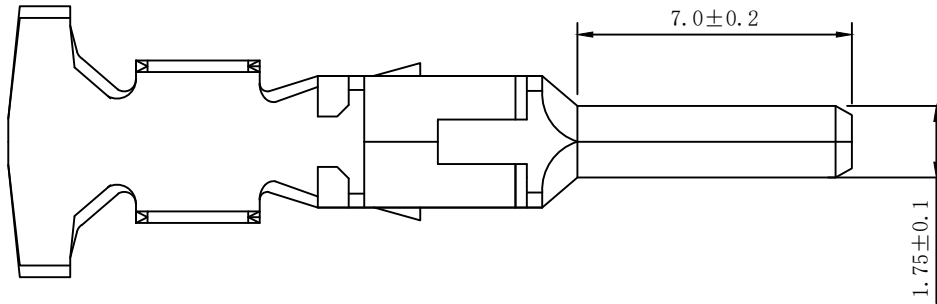
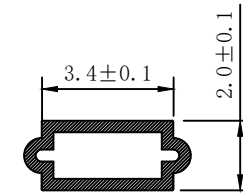
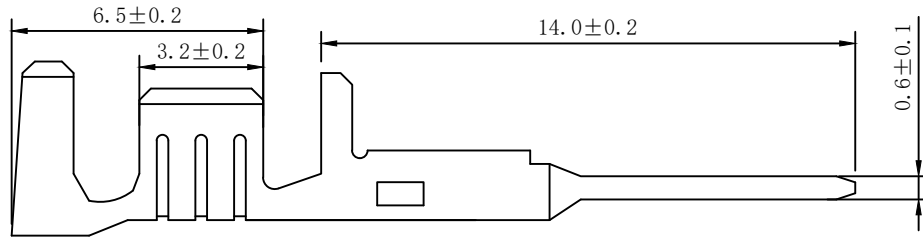

Specifications:

1. Applicable Wires: AWG22-20#
2. Material: 0.3mm Brass
3. Plating: Tin plated

THIS DRAWING IS A CONTROLLED DOCUMENT.		DROWN 21-02-2009 ARONG PAN	Yueqing Hegxing Electronic Co.,ltd		
DIMENSIONS: MM		Checked 23-04-2009 YUNJIAN LIN	NAME		
TOLERANCES ACCORDING TO THE DRAWING SPECIFIED		Approved 13-05-2009 DUQING LI	070 B TYPE MALE TERMINAL		
		PRODUCT SPEC	SIZE	GAGE CODE	DRAWING NO
Material: 0.30 mm BRASS		FINISH: TIN PLATED	A4		35745-0110
CUSTOMER DRAWING			RESTRICTED TO	SCALE	SHEET 1 OF 1
			REV		

REVISIONS

P	LTR	DESCRIPTION	DATE	DWN	APVD

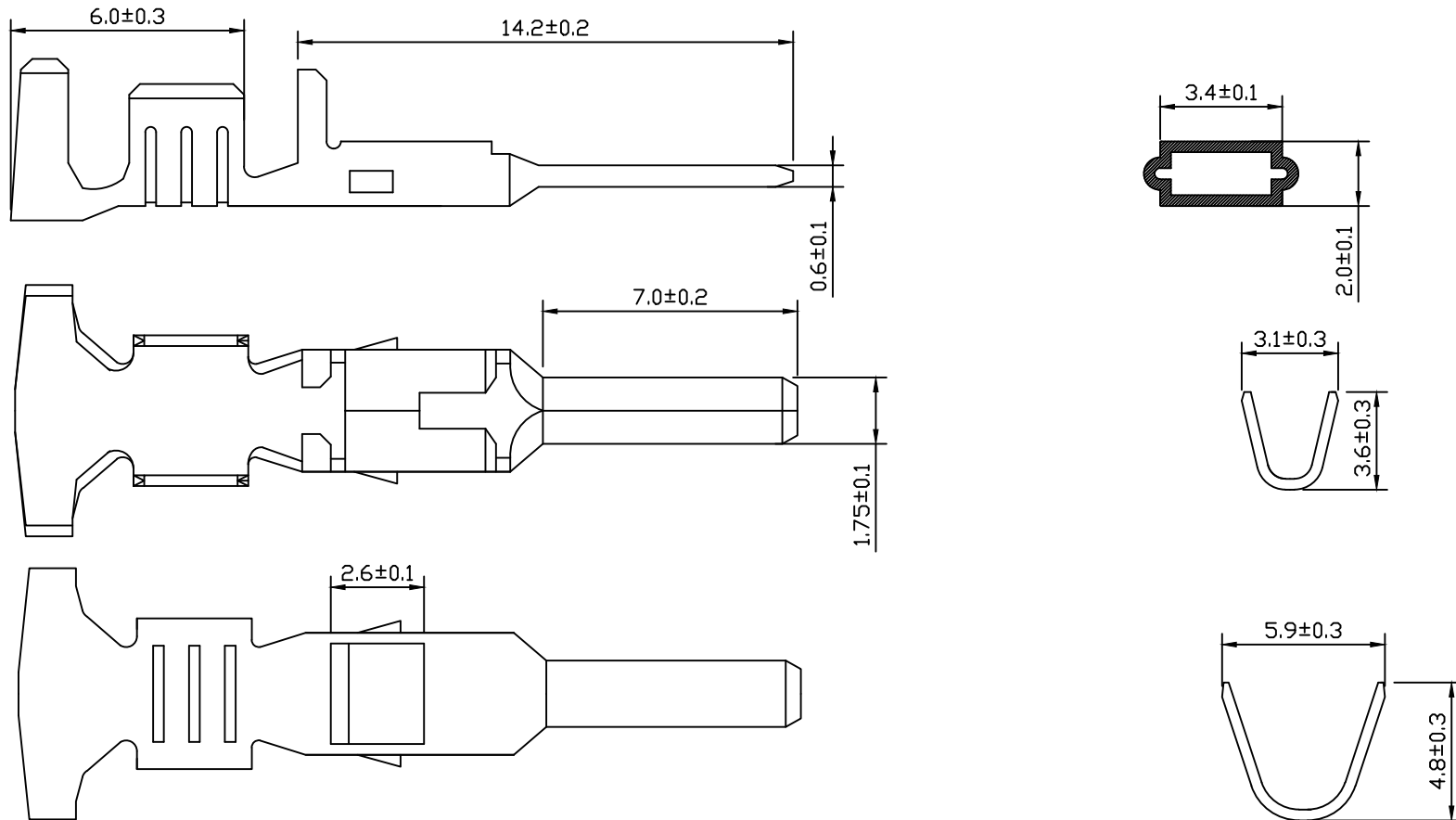

Specifications:

1. Applicable Wires: AWG18-14#
2. Material: 0.3mm Brass
3. Finish: Pre-plated Tin

THIS DRAWING IS A CONTROLLED DOCUMENT.		DROWN 21-02-2009 ARONG PAN	Yueqing Hegxing Electronic Co.,ltd		
DIMENSIONS: MM		Checked 23-04-2009 YUNJIAN LIN	NAME		
TOLERANCES ACCORDING TO THE DRAWING SPECIFIED.		Approved 13-05-2009 DUQING LI	070 A TYPE MALE TERMINAL		
		PRODUCT SPEC	SIZE	GAGE CODE	DRAWING NO
Material: 0.30 mm BRASS		FINISH: TIN PLATED	A4		(35745-0210)
APPLICATION SPEC			RESTRICTED TO		
WEIGHT			CUSTOMER DRAWING	SCALE	SHEET 1 OF 1
					REV

REVISIONS

P	LTR	DESCRIPTION	DATE	DWN	APVD

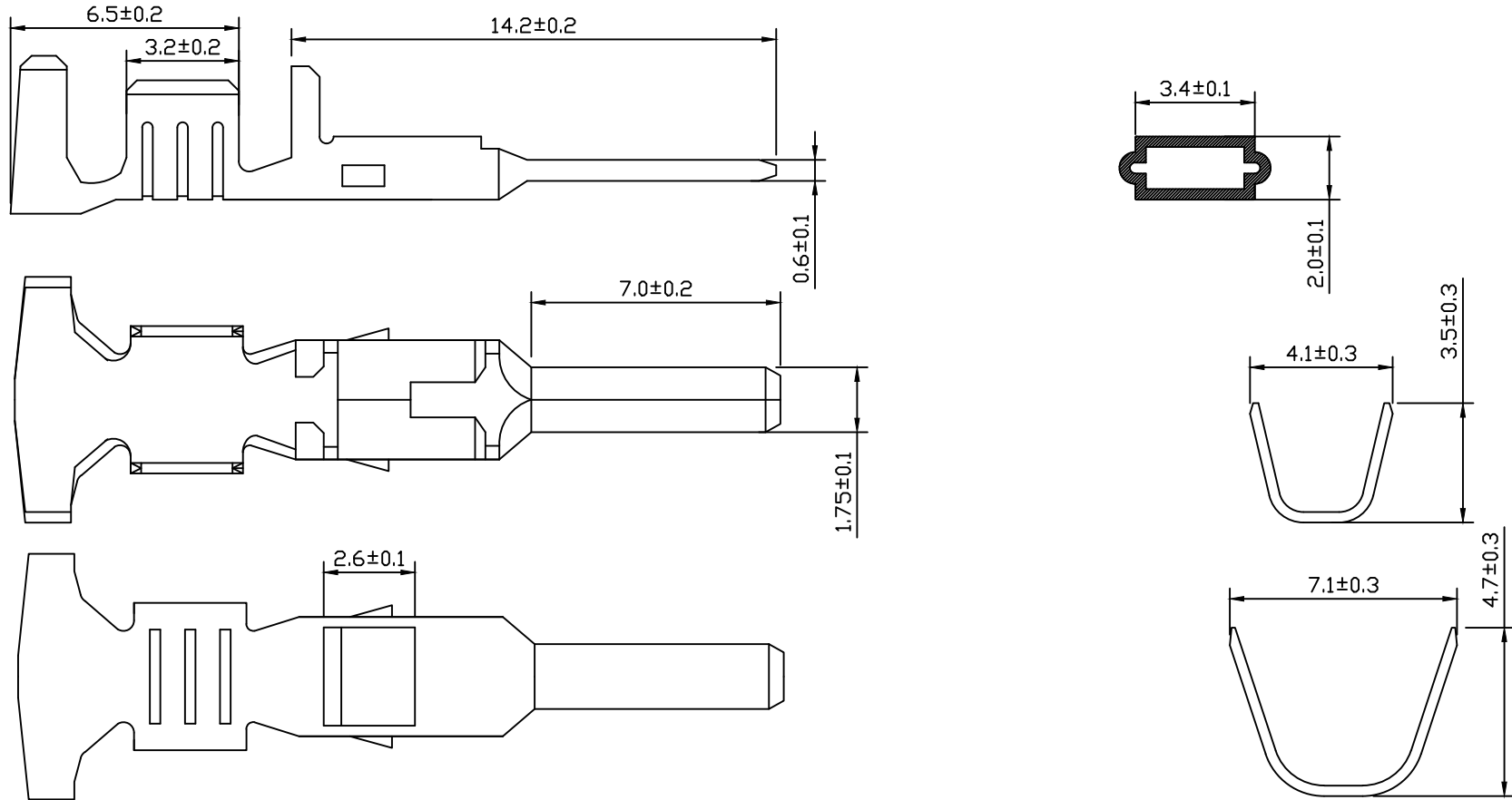

Specifications:

1. Applicable Wires:
AWG20#+20# or AWG20#+18# or AWG18#+18#
2. Material: 0.3mm Brass
3. Finish: Pre-plated Tin

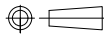
THIS DRAWING IS A CONTROLLED DOCUMENT.		DROWN 21-02-2009 ARONG PAN	Yueqing Hegxing Electronic Co.,ltd		
DIMENSIONS: MM		Checked 23-04-2009 YUNJIAN LIN	NAME		
TOLERANCES ACCORDING TO THE DRAWING SPECIFIED.		Approved 13-05-2009 DUQING LI	070 A TYPE MALE TERMINAL		
		PRODUCT SPEC	SIZE	GAGE CODE	DRAWING NO
Material: 0.30 mm BRASS		FINISH: TIN PLATED	A4		(35745-0310)
		APPLICATION SPEC	WEIGHT	RESTRICTED TO	
CUSTOMER DRAWING			SCALE	SHEET 1 OF 1	REV

REVISIONS

P	LTR	DESCRIPTION	DATE	DWN	APVD

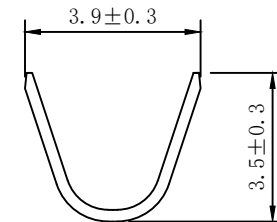
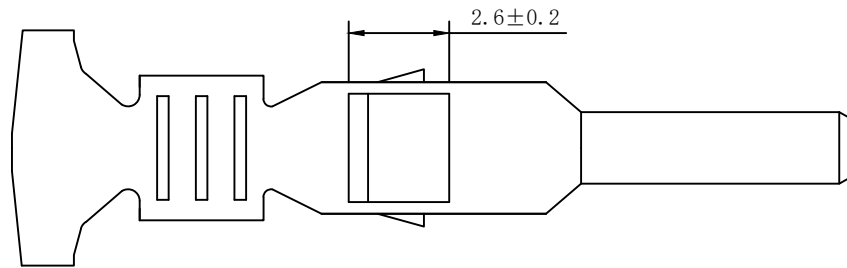
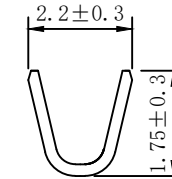
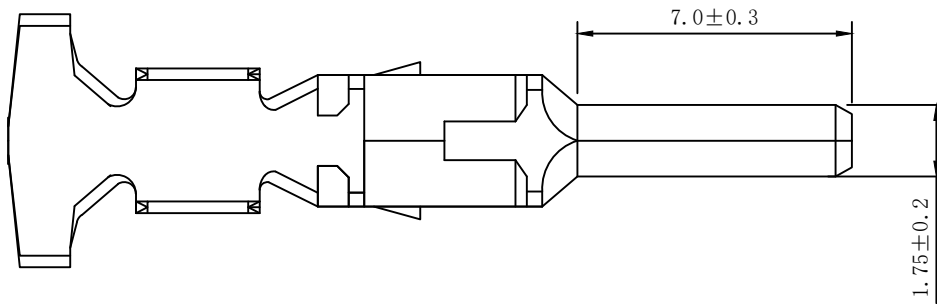
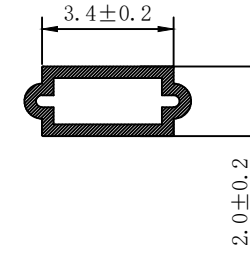
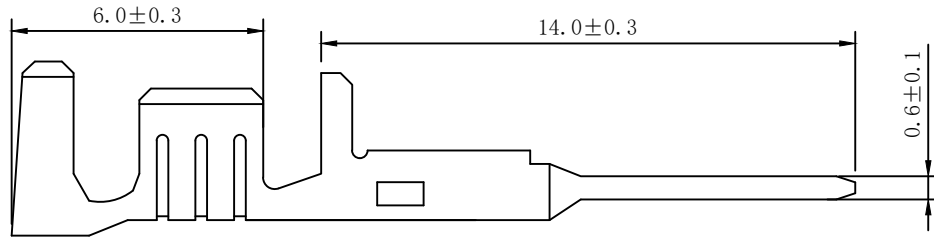

Specifications:

1. Applicable Wires: AWG24-22#
2. Material: 0.3mm Brass
3. Finish: Pre-plated Tin

THIS DRAWING IS A CONTROLLED DOCUMENT.		DROWN 21-02-2009 ARONG PAN	Yueqing Hegxing Electronic Co.,ltd		
DIMENSIONS: MM		Checked 23-04-2009 YUNJIAN LIN	NAME		
TOLERANCES ACCORDING TO THE DRAWING SPECIFIED.		Approved 13-05-2009 DUQING LI	070 A TYPE MALE TERMINAL		
		PRODUCT SPEC	SIZE	GAGE CODE	DRAWING NO
Material: 0.30 mm BRASS		FINISH: TIN PLATED	A4		(35745-0410)
CUSTOMER DRAWING			RESTRICTED TO	SCALE	SHEET 1 OF 1
			REV		