

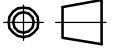

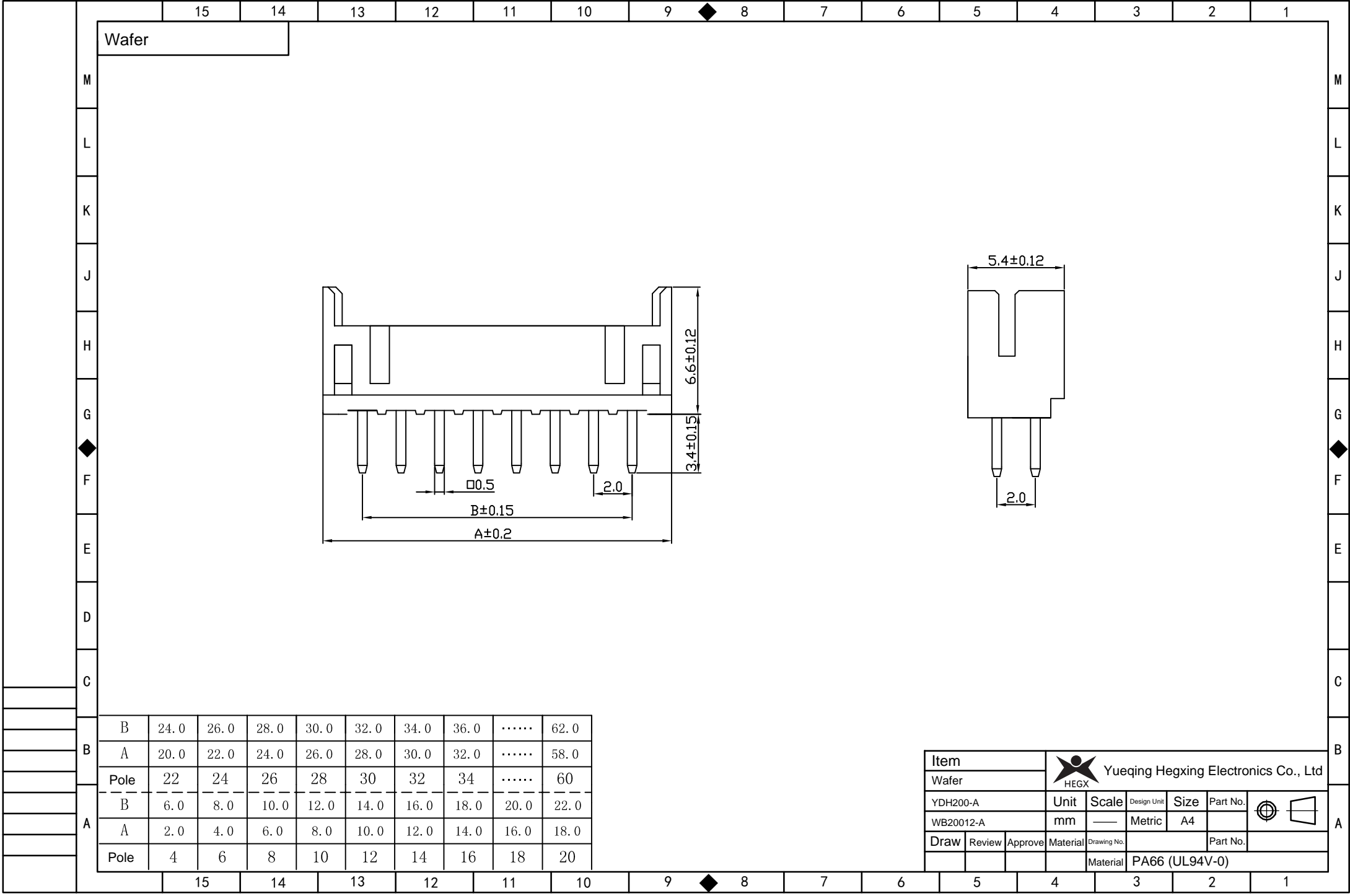

C	6.0	8.0	10.0	12.0	14.0	16.0	18.0	20.0	22.0	24.0	26.0	28.0	30.0	32.0	...	62.0
B	4.4	6.4	8.4	10.4	12.4	14.4	16.4	18.4	20.4	22.4	24.4	26.4	28.4	30.4	...	64.4
A	2.0	4.0	6.0	8.0	10.0	12.0	14.0	16.0	18.0	20.0	22.0	24.0	26.0	28.0	...	58.0
孔数	4	6	8	10	12	14	16	18	20	22	24	26	28	30	...	60

Item		 Yueqing Hegxing Electronics Co., Ltd				
Plug Housing		Unit	Scale	Design Unit	Size	Part No.
YDH200-Y		mm	—	Metric	A4	
Draw	Review	Approve	Material	Drawing No.	Part No.	
			Material	PA66 (UL94V-0)		



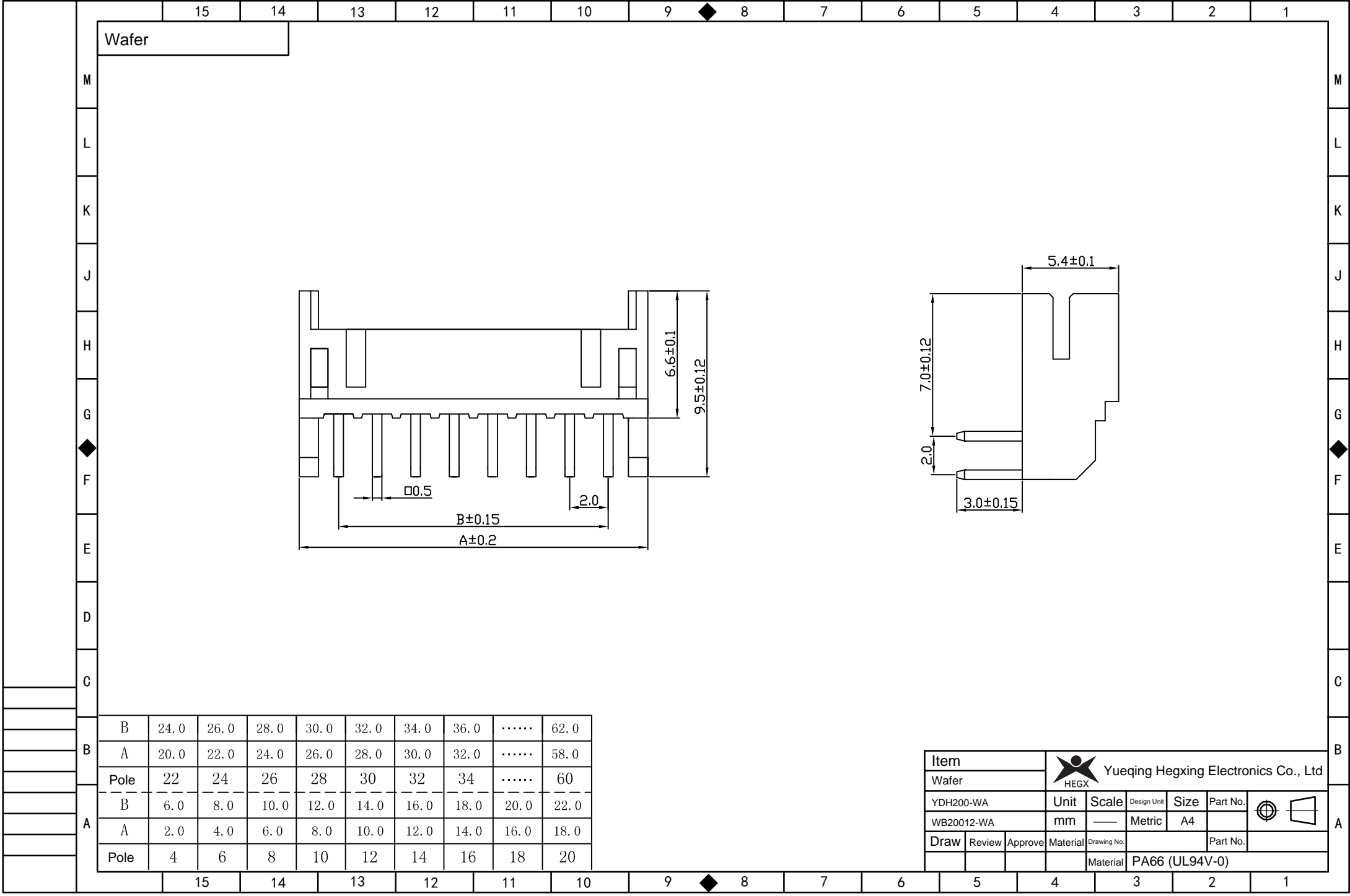

B	B	24.0	26.0	28.0	30.0	32.0	34.0	36.0	62.0
B	A	20.0	22.0	24.0	26.0	28.0	30.0	32.0	58.0
B	Pole	22	24	26	28	30	32	34	60
A	B	6.0	8.0	10.0	12.0	14.0	16.0	18.0	20.0	22.0
A	A	2.0	4.0	6.0	8.0	10.0	12.0	14.0	16.0	18.0
A	Pole	4	6	8	10	12	14	16	18	20

Item		 Yueqing Hegxing Electronics Co., Ltd							
Wafer		Unit	Scale	Design Unit	Size	Part No.	 		
YDH200-A		mm	—	Metric	A4				
Draw	Review	Approve	Material	Drawing No.	Part No.				
		Material		PA66 (UL94V-0)					



B	B	24.0	26.0	28.0	30.0	32.0	34.0	36.0	62.0
B	A	20.0	22.0	24.0	26.0	28.0	30.0	32.0	58.0
B	Pole	22	24	26	28	30	32	34	60
A	B	6.0	8.0	10.0	12.0	14.0	16.0	18.0	20.0	22.0
A	A	2.0	4.0	6.0	8.0	10.0	12.0	14.0	16.0	18.0
A	Pole	4	6	8	10	12	14	16	18	20

Item		 Yueqing Hegxing Electronics Co., Ltd							
Wafer		Unit	Scale	Design Unit	Size	Part No.	 		
YDH200-WA		mm	—	Metric	A4				
WB20012-WA		mm	—	Metric	A4				
Draw	Review	Approve	Material	Drawing No.	Part No.				
		Material		PA66 (UL94V-0)					

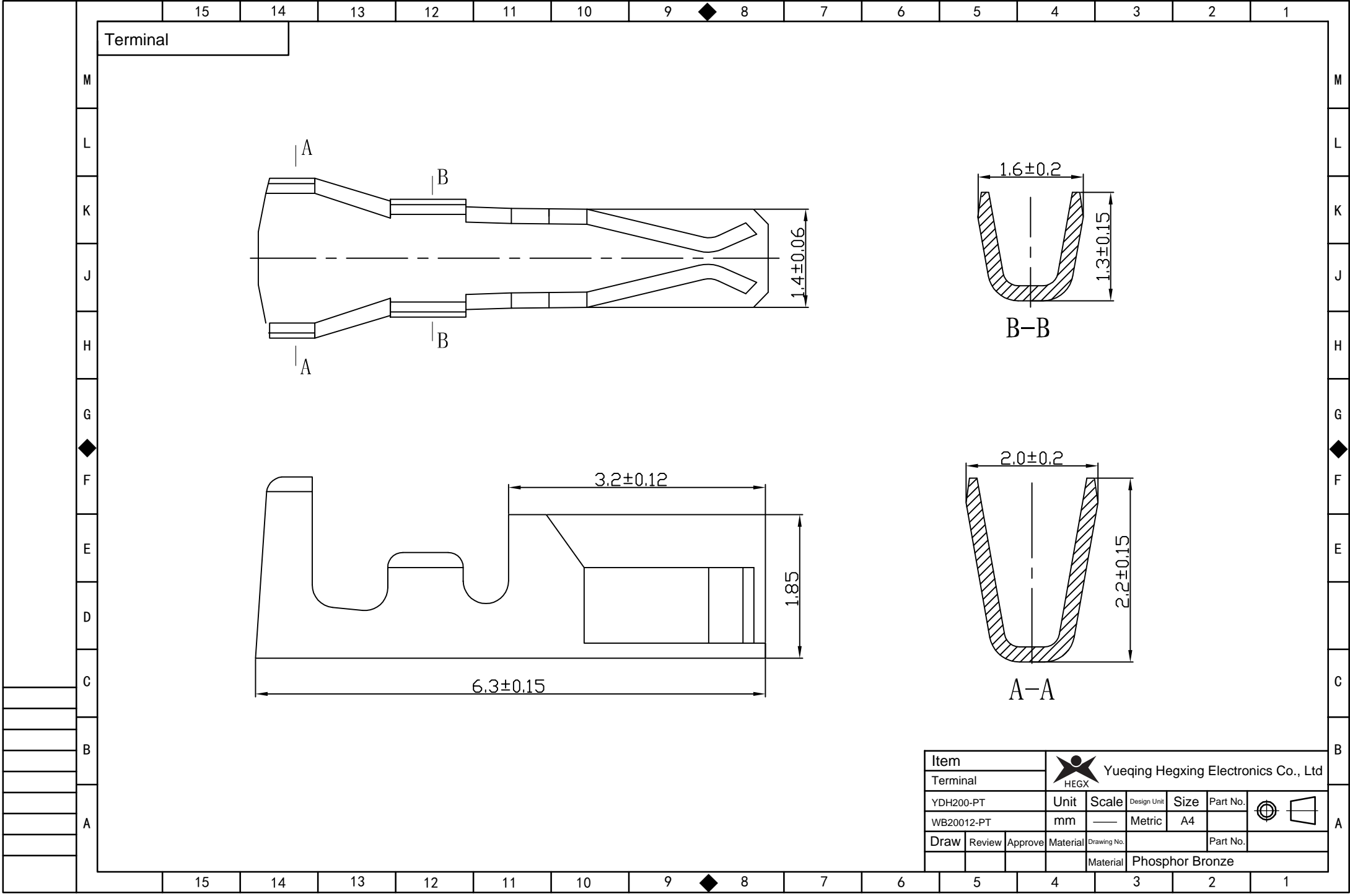

Terminal

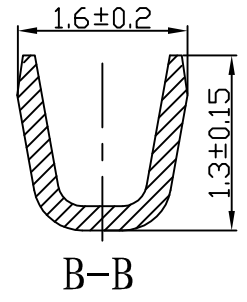

B-B

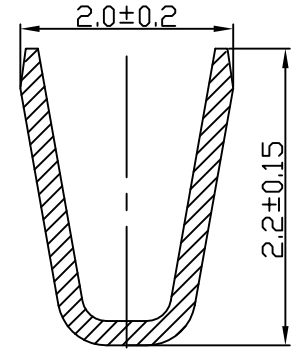

A-A

Item		 Yueqing Hegxing Electronics Co., Ltd				
Terminal		Unit	Scale	Design Unit	Size	Part No.
YDH200-PT		mm	—	Metric	A4	
Draw	Review	Approve	Material	Drawing No.	Part No.	
			Material	Phosphor Bronze		