

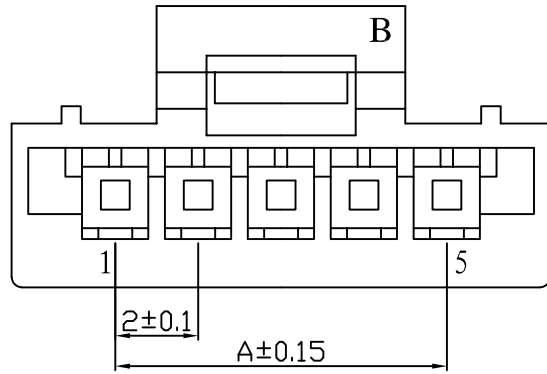

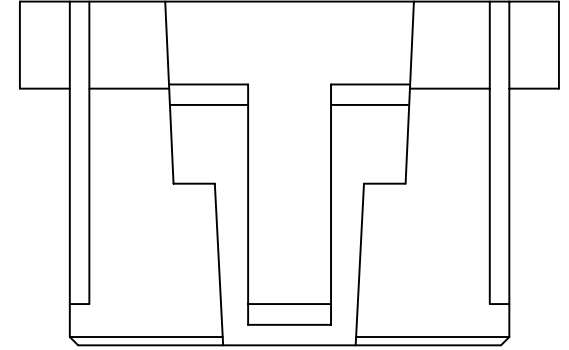

Plug Housing

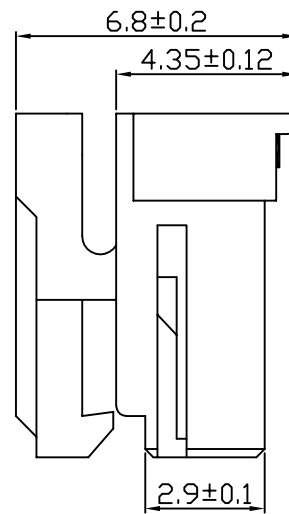

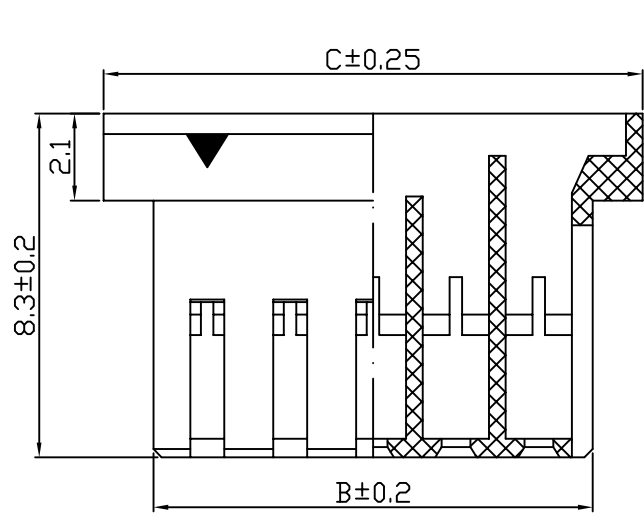

C	7	9	11	13	15	17	19	21	23	25	27	29	31	33
B	4.6	6.6	8.6	10.6	12.6	14.6	16.6	18.6	20.6	22.6	24.6	26.6	28.6	30.6
A	2	4	6	8	10	12	14	16	18	20	22	24	26	28
Pole	2	3	4	5	6	7	8	9	10	11	12	13	14	15

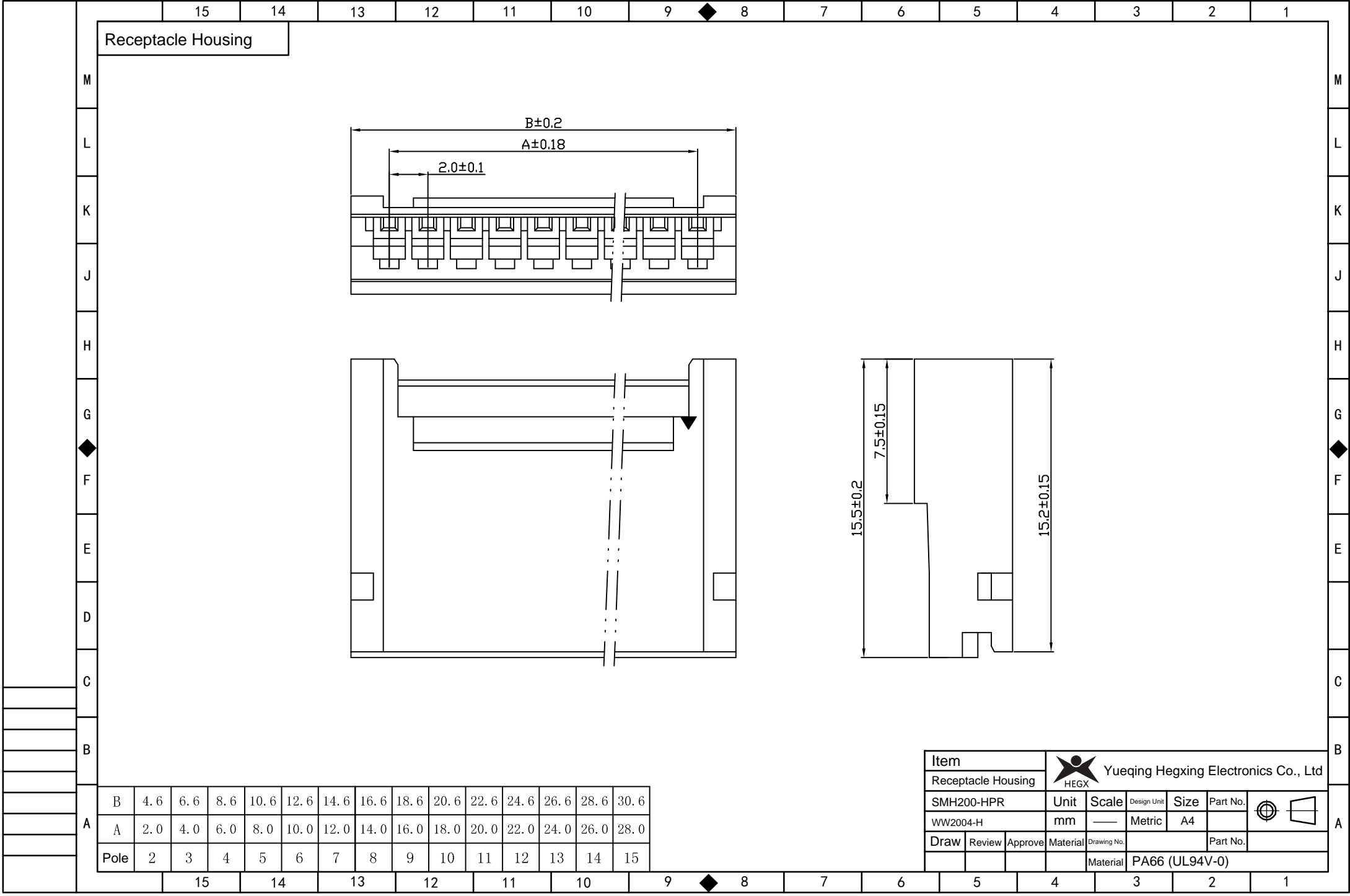
Item		 Yueqing Hegxing Electronics Co., Ltd									
Plug Housing		Unit	Scale	Design Unit	Size	Part No.	 				
SMH200-NNH		mm	—	Metric	A4						
Draw	Review	Approve	Material	Drawing No.	Part No.						
		Material		PA66 (UL94V-0)							



B	4.6	6.6	8.6	10.6	12.6	14.6	16.6	18.6	20.6	22.6	24.6	26.6	28.6	30.6
A	2.0	4.0	6.0	8.0	10.0	12.0	14.0	16.0	18.0	20.0	22.0	24.0	26.0	28.0
Pole	2	3	4	5	6	7	8	9	10	11	12	13	14	15

Item		 Yueqing Hegxing Electronics Co., Ltd						
Receptacle Housing		Unit	Scale	Design Unit	Size	Part No.		
SMH200-HPR		mm	—	Metric	A4			
Draw	Review	Approve	Material	Drawing No.	Part No.			
			Material	PA66 (UL94V-0)				

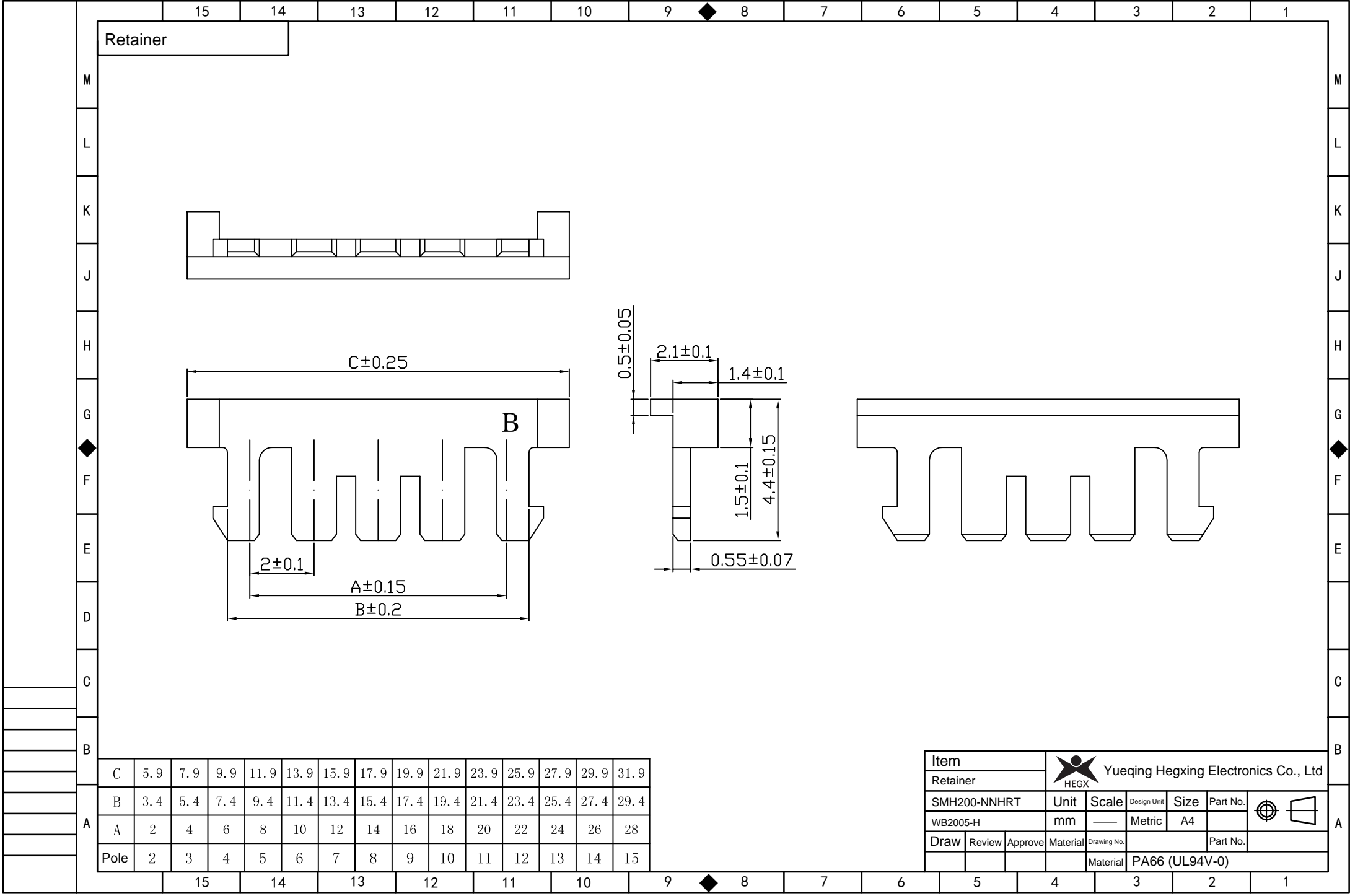

C	5.9	7.9	9.9	11.9	13.9	15.9	17.9	19.9	21.9	23.9	25.9	27.9	29.9	31.9
B	3.4	5.4	7.4	9.4	11.4	13.4	15.4	17.4	19.4	21.4	23.4	25.4	27.4	29.4
A	2	4	6	8	10	12	14	16	18	20	22	24	26	28
Pole	2	3	4	5	6	7	8	9	10	11	12	13	14	15

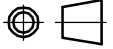
Item		 Yueqing Hegxing Electronics Co., Ltd						
Retainer		Unit	Scale	Design Unit	Size	Part No.		
SMH200-NNHRT		mm	—	Metric	A4			
Draw	Review	Approve	Material	Drawing No.	Part No.			
		Material		PA66 (UL94V-0)				

PHB Type Wafer

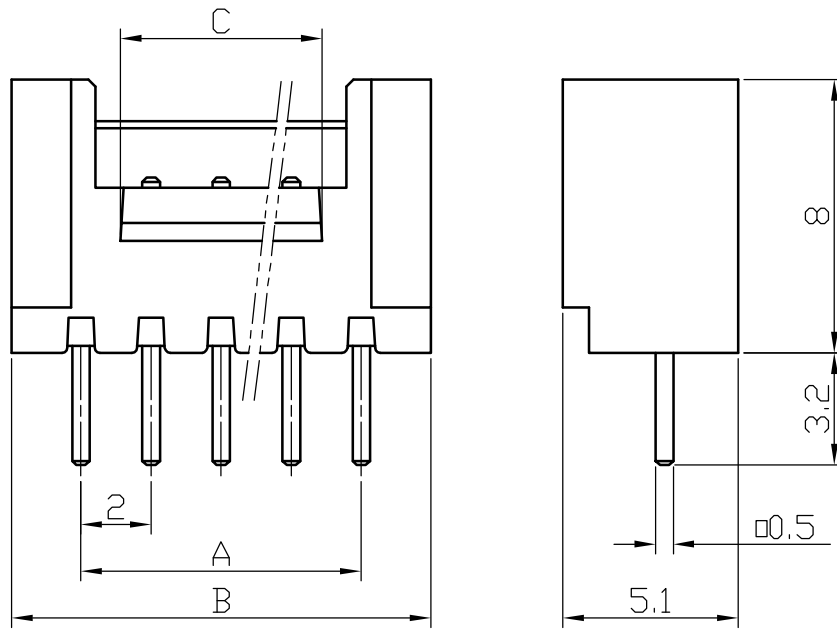

Poles	Part No.		Dimensions		
			A	B	C
2	WB2005-PT02	PHB-2A	2	6	3
3	WB2005-PT03	PHB-3A	4	8	3.5
4	WB2005-PT04	PHB-4A	6	10	4
5	WB2005-PT05	PHB-5A	8	12	6
6	WB2005-PT06	PHB-6A	10	14	8
7	WB2005-PT07	PHB-7A	12	16	10
8	WB2005-PT08	PHB-8A	14	18	12
9	WB2005-PT09	PHB-9A	16	20	14
10	WB2005-PT10	PHB-10A	18	22	16
11	WB2005-PT11	PHB-11A	20	24	18
12	WB2005-PT12	PHB-12A	22	26	20
13	WB2005-PT13	PHB-13A	24	28	22
14	WB2005-PT14	PHB-14A	26	30	24
15	WB2005-PT15	PHB-15A	28	32	26
16	WB2005-PT16	PHB-16A	30	34	28

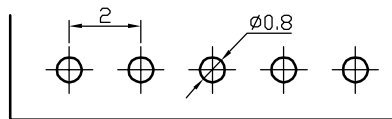

PCB Layout

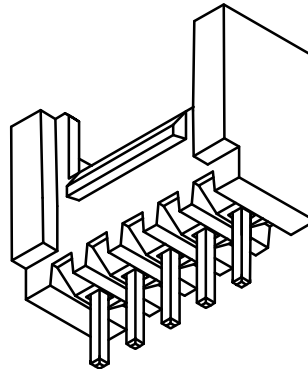

2	Pin	Tin Plated Brass	N						
1	Housing	PA9T (UL94V-0)	1						
No.	Item/Material No.	Material	QTY	Remark					
Unmarked Tolerance		Yueqing Hegxing Electronics Co., Ltd							
X. ° ±3° X. X° ±0.5°									
>0-3	>3-18	>18-50	>50-120	Unit	Scale	Design Unit	Size	Part No.	
±0.12	±0.15	±0.3	±0.5	mm	—	Metric	A4		
Draw	Review	Approve	Material	Drawing No.			Part No.		
				Item	PHB-NA				

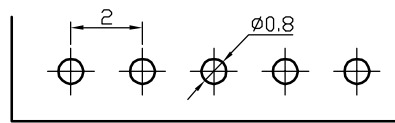
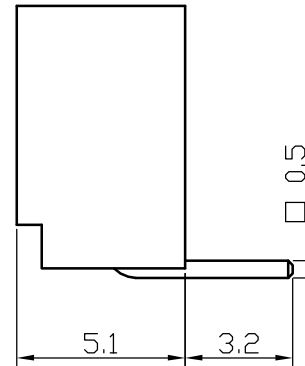
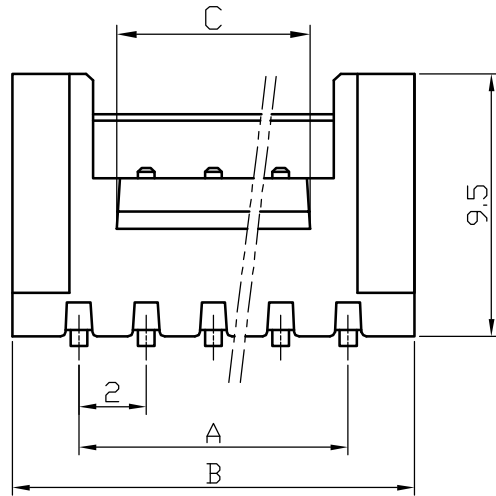

PHB Type Wafer



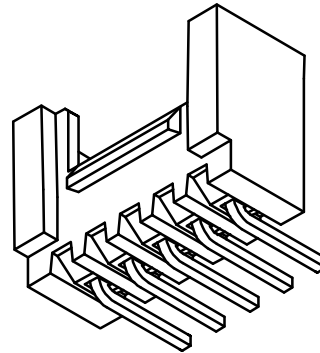

PCB Layout



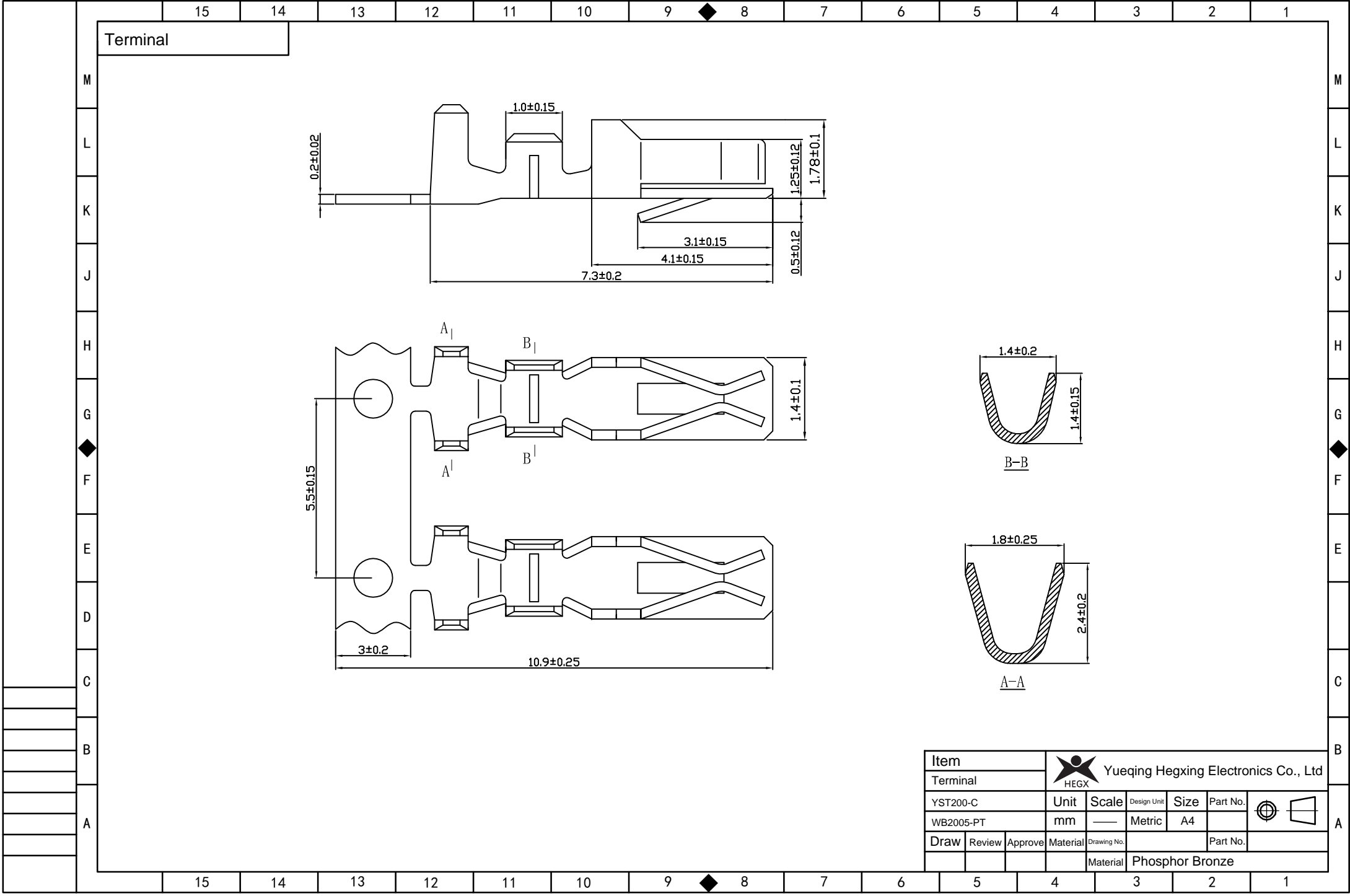

Poles	PAWDrt No.		Dimensions		
			A	B	C
2	WB2005-PSB02	PHB-2AW	2	6	3
3	WB2005-PSB03	PHB-3AW	4	8	3.5
4	WB2005-PSB04	PHB-4AW	6	10	4
5	WB2005-PSB05	PHB-5AW	8	12	6
6	WB2005-PSB06	PHB-6AW	10	14	8
7	WB2005-PSB07	PHB-7AW	12	16	10
8	WB2005-PSB08	PHB-8AW	14	18	12
9	WB2005-PSB09	PHB-9AW	16	20	14
10	WB2005-PSB10	PHB-10AW	18	22	16
11	WB2005-PSB11	PHB-11AW	20	24	18
12	WB2005-PSB12	PHB-12AW	22	26	20
13	WB2005-PSB13	PHB-13AW	24	28	22
14	WB2005-PSB14	PHB-14AW	26	30	24
15	WB2005-PSB15	PHB-15AW	28	32	26
16	WB2005-PSB16	PHB-16AW	30	34	28

2	Pin	Tin Plated Brass	N						
1	Housing	PA9T (UL94V-0)	1						
No.	Item/Material No.	Material	QTY	Remark					
Unmarked Tolerance		 Yueqing Hegxing Electronics Co., Ltd							
X. ° ±3°	X. X° ±0.5°								
>0-3	>3-18	>18-50	>50-120	Unit	Scale	Design Unit	Size	Part No.	 
±0.12	±0.15	±0.3	±0.5	mm	—	Metric	A4		
Draw	Review	Approve	Material	Drawing No.			Part No.		
				Item	PHB-NAW				

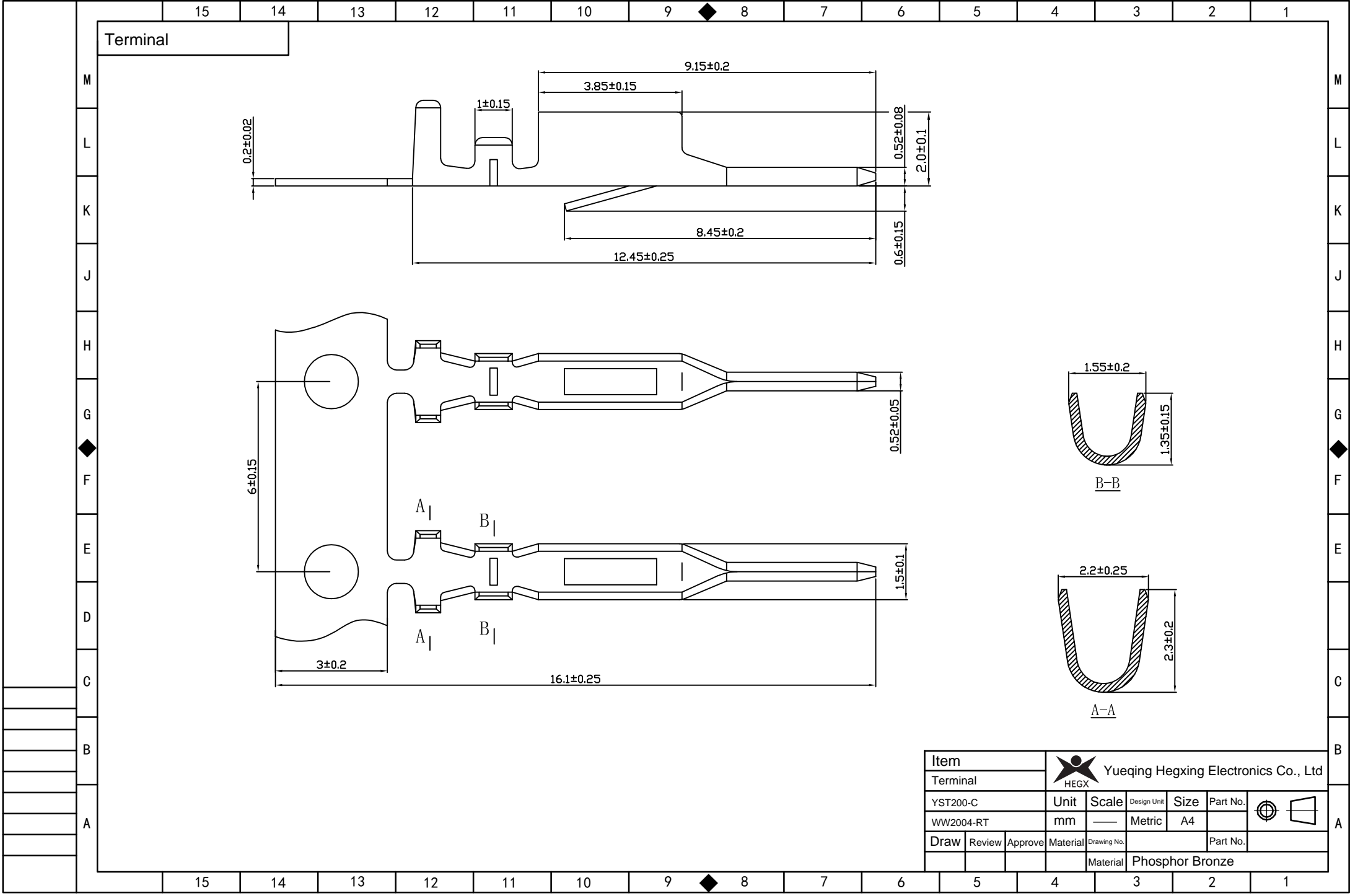

Item		 Yueqing Hegxing Electronics Co., Ltd				
Terminal		Unit	Scale	Design Unit	Size	Part No.
YST200-C		mm	—	Metric	A4	
Draw	Review	Approve	Material	Drawing No.	Part No.	
			Material	Phosphor Bronze		



Item		 Yueqing Hegxing Electronics Co., Ltd				
Terminal		Unit	Scale	Design Unit	Size	Part No.
YST200-C		mm	—	Metric	A4	
Draw	Review	Approve	Material	Drawing No.	Part No.	
			Material	Phosphor Bronze		