

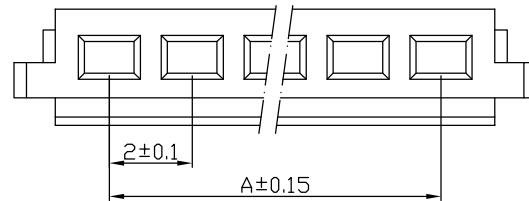

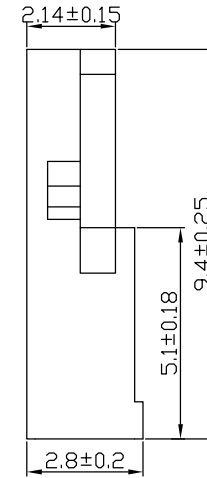

Plug Housing

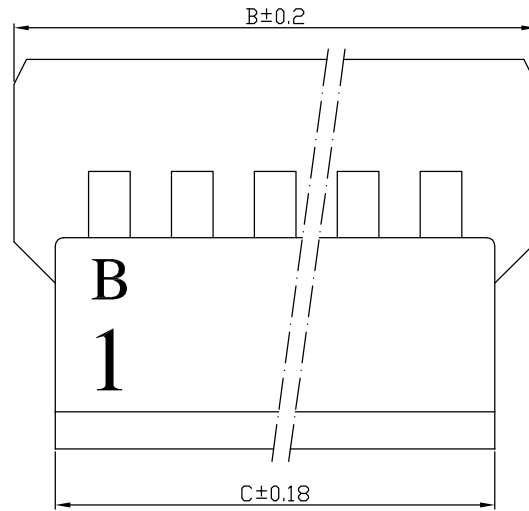

C	4.6	6.6	8.6	10.6	12.6	14.6	16.6	18.6	20.6	22.6	24.6	26.6	28.6	30.6
B	6.6	8.6	10.6	12.6	14.6	16.6	18.6	20.6	22.6	24.6	26.6	28.6	30.6	32.6
A	2.0	4.0	6.0	8.0	10.0	12.0	14.0	16.0	18.0	20.0	22.0	24.0	26.0	28.0
Pole	2P	3P	4P	5P	6P	7P	8P	9P	10P	11P	12P	13P	14P	15P

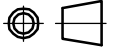
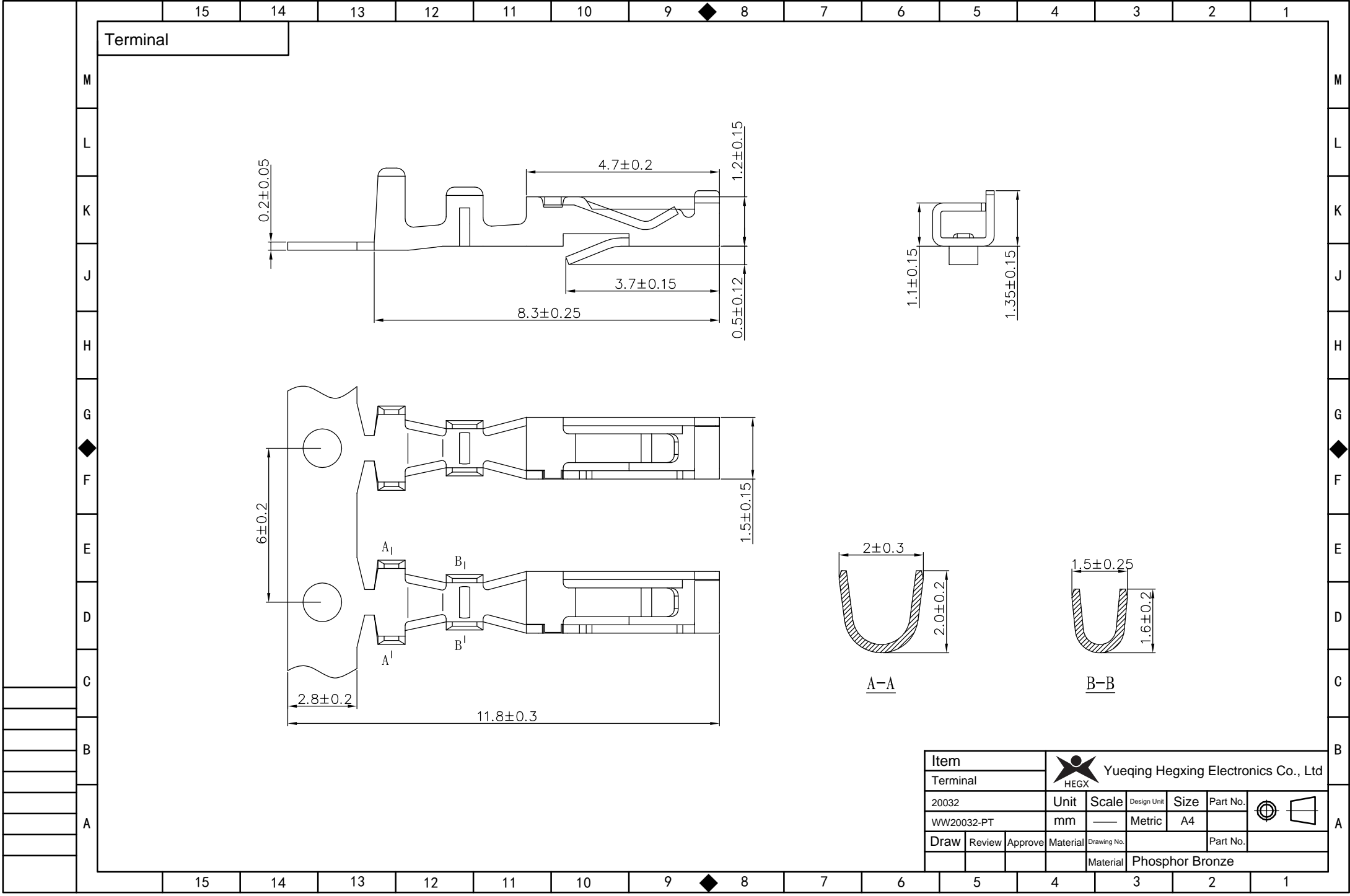
Item		 Yueqing Hegxing Electronics Co., Ltd												
Plug Housing		Unit	Scale	Design Unit	Size	Part No.								
20032		mm	—	Metric	A4									
Draw	Review	Approve	Material	Drawing No.	Part No.									
			Material	PA66 (UL94V-0)										



Item		 Yueqing Hegxing Electronics Co., Ltd				
Terminal		Unit	Scale	Design Unit	Size	Part No.
20032		mm	—	Metric	A4	
Draw	Review	Approve	Material	Drawing No.	Part No.	
			Material	Phosphor Bronze		

Receptacle Housing

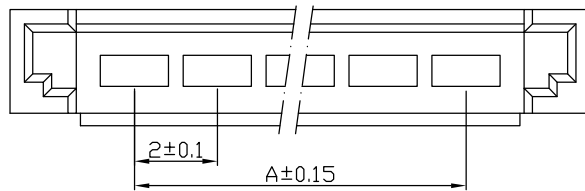
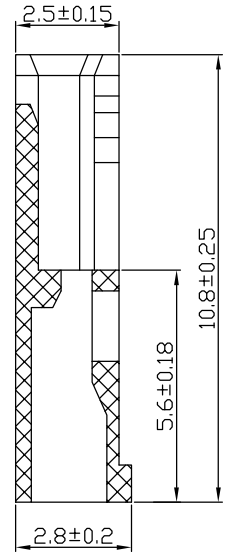
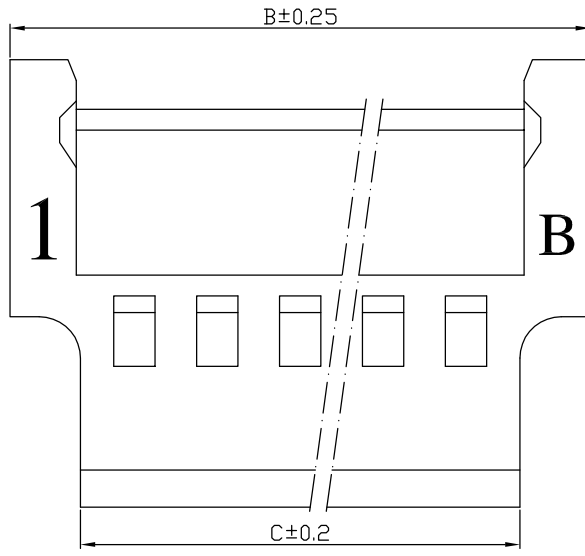

C	4.6	6.6	8.6	10.6	12.6	14.6	16.6	18.6	20.6	22.6	24.6	26.6	28.6	30.6
B	8.0	10.0	12.0	14.0	16.0	18.0	20.0	22.0	24.0	26.0	28.0	30.0	32.0	34.0
A	2.0	4.0	6.0	8.0	10.0	12.0	14.0	16.0	18.0	20.0	22.0	24.0	26.0	28.0
Pole	2P	3P	4P	5P	6P	7P	8P	9P	10P	11P	12P	13P	14P	15P

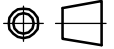
Item		 Yueqing Hegxing Electronics Co., Ltd									
Receptacle Housing		Unit	Scale	Design Unit	Size	Part No.					
20032		mm	—	Metric	A4						
Draw	Review	Approve	Material	Drawing No.	Part No.						
				Material PA66 (UL94V-0)							

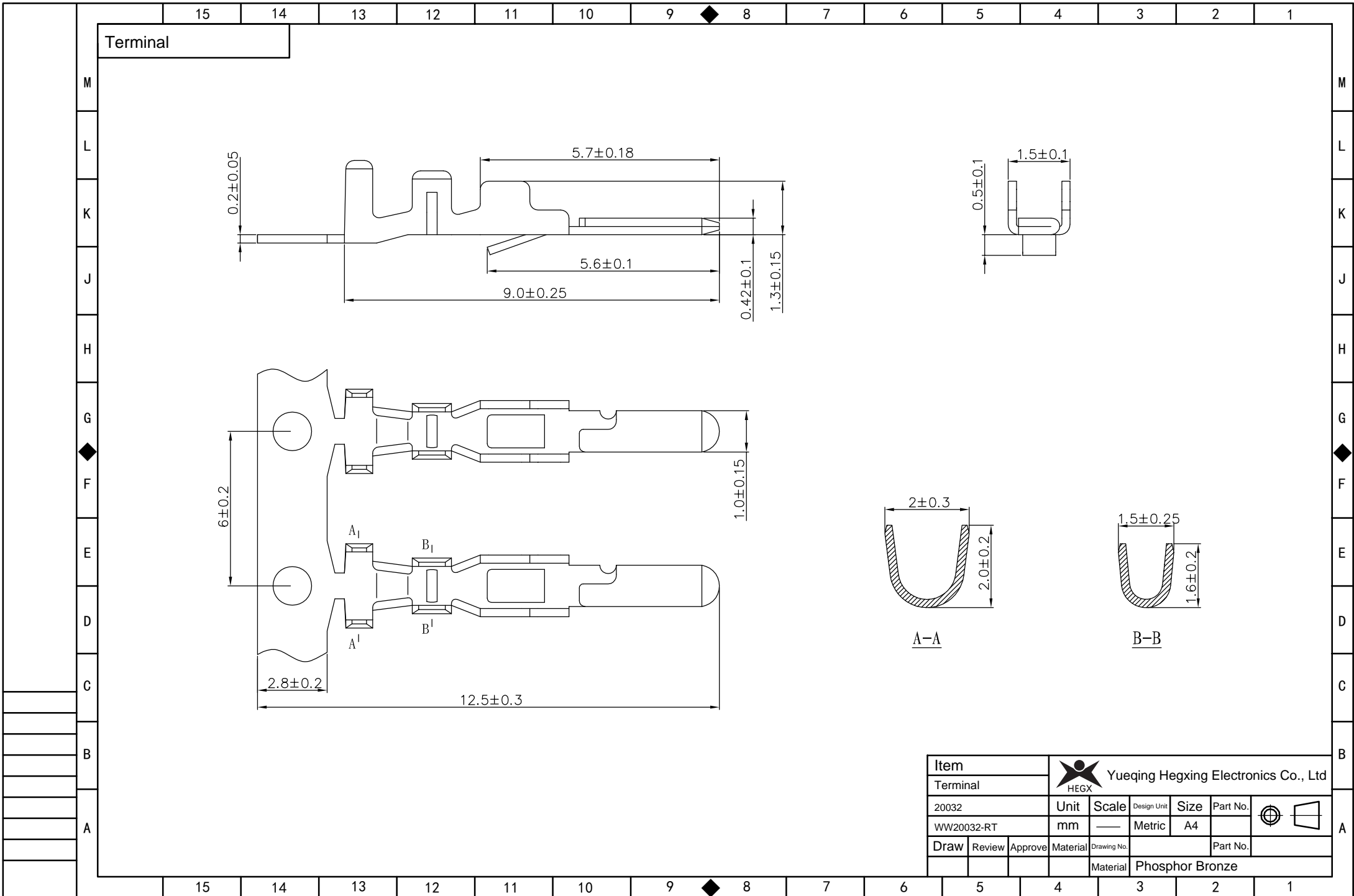

Item		 Yueqing Hegxing Electronics Co., Ltd				
Terminal		Unit	Scale	Design Unit	Size	Part No.
20032		mm	—	Metric	A4	
WW20032-RT		Draw	Review	Approve	Material	Part No.
					Material	Phosphor Bronze