

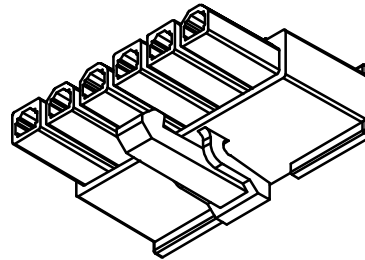

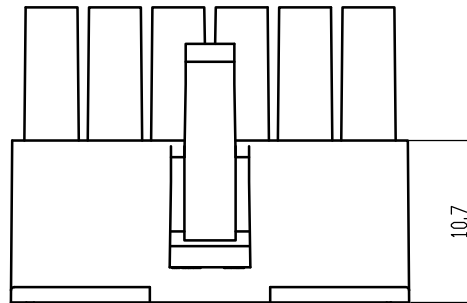

5557 Type Housing

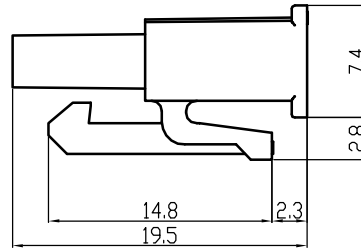

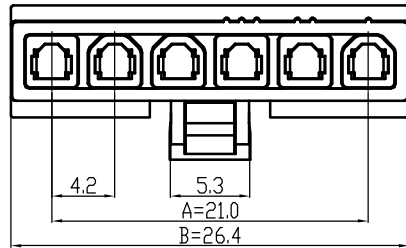
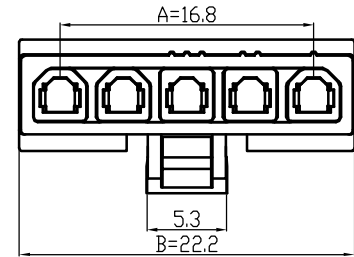
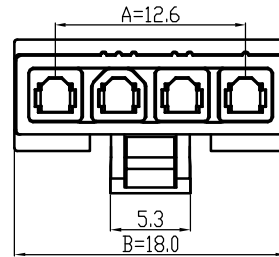
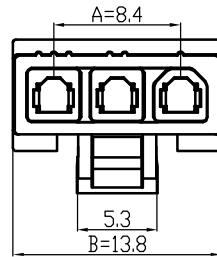
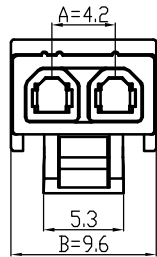

Poles	Part No.		Dimensions	
			A	B
2	WW4201-H02	5557-2Y	4.2	9.6
3	WW4201-H03	5557-3Y	8.4	13.8
4	WW4201-H04	5557-4Y	12.6	18
5	WW4201-H05	5557-5Y	16.8	22.2
6	WW4201-H06	5557-6Y	21	26.4

1	Housing	PA66(UL94V-0/V-2)	1	White					
No.	Item/Material No.	Material	QTY	Remark					
Unmarked Tolerance		 Yueqing Hegxing Electronics Co., Ltd							
X. ° ±3° X. X° ±0.5°									
>0-3	>3-18	>18-50	>50-120	Unit	Scale	Design Unit	Size	Part No.	 
±0.12	±0.15	±0.3	±0.5	mm	—	Metric	A4		
Draw	Review	Approve	Material	Drawing No.		Part No.			
				Item	5557-NY				

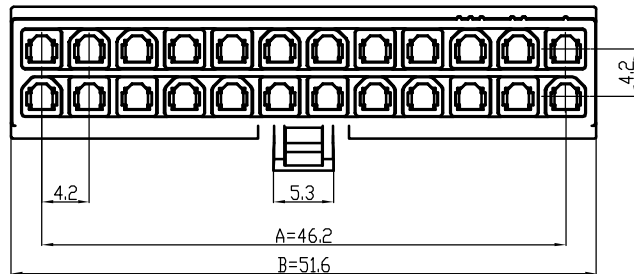
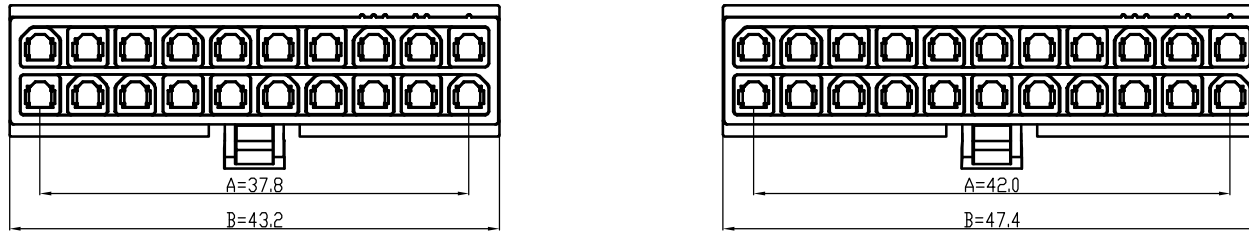
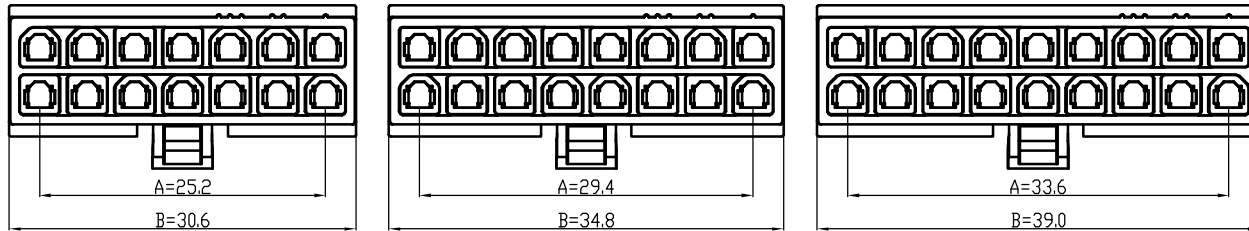
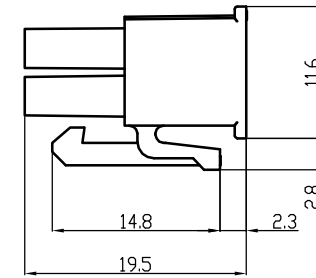
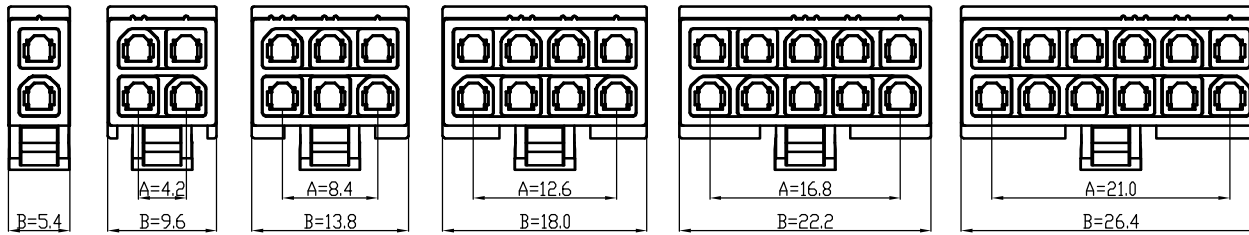
5557 Type Housing



Poles	Part No.		Dimensions	
			A	B
2	WW4201-H01x2	5557-2x1Y	-	5.4
4	WW4201-H02x2	5557-2x2Y	4.2	9.6
6	WW4201-H03x2	5557-2x3Y	8.4	13.8
8	WW4201-H04x2	5557-2x4Y	12.6	18
10	WW4201-H05x2	5557-2x5Y	16.8	22.2
12	WW4201-H06x2	5557-2x6Y	21	26.4
14	WW4201-H07x2	5557-2x7Y	25.2	30.6
16	WW4201-H08x2	5557-2x8Y	29.4	34.8
18	WW4201-H09x2	5557-2x9Y	33.6	39
20	WW4201-H10x2	5557-2x10Y	37.8	43.2
22	WW4201-H11x2	5557-2x11Y	42	47.4
24	WW4201-H12x2	5557-2x12Y	46.2	51.6

1	Housing	PA66(UL94V-0/V-2)	1	White					
No.	Item/Material No.	Material	QTY	Remark					
Unmarked Tolerance		 Yueqing Hegxing Electronics Co., Ltd							
X. ° ±3° X. X. ° ±0.5°									
>0-3	>3-18	>18-50	>50-120	Unit	Scale	Design Unit	Size	Part No.	 
±0.12	±0.15	±0.3	±0.5	mm	—	Metric	A4		
Draw	Review	Approve	Material	Drawing No.	Part No.				
				Item	5557-2xNY				

5557 Type Housing

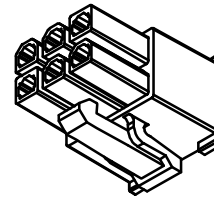
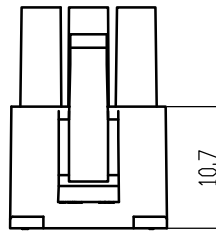
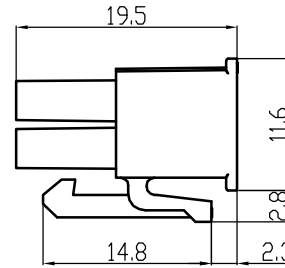
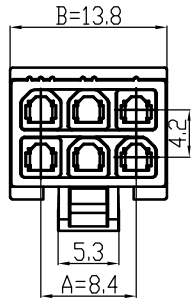



Poles	Part No.		Dimensions	
			A	B
6	WW4201-HB03x2	5557-2x3YB	8.4	13.8

1	Housing	PA66(UL94V-0/V-2)	1	White					
No.	Item/Material No.	Material	QTY	Remark					
Unmarked Tolerance		 Yueqing Hegxing Electronics Co., Ltd							
X. ° ±3° X. X° ±0.5°									
>0-3	>3-18	>18-50	>50-120	Unit	Scale	Design Unit	Size	Part No.	 
±0.12	±0.15	±0.3	±0.5	mm	—	Metric	A4		
Draw	Review	Approve	Material	Drawing No.	Part No.				
				Item	5557-2x3YB				

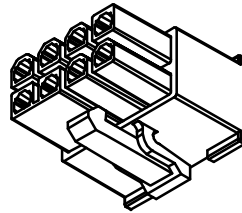
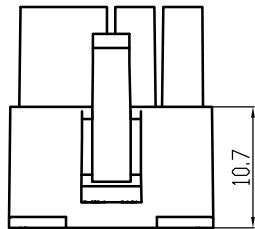
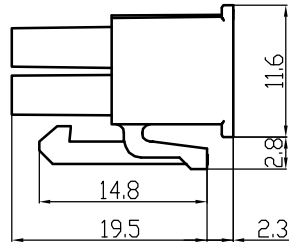
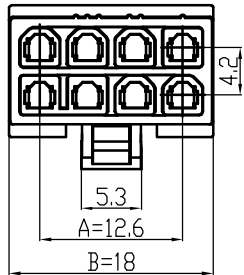
5557 Type Housing



Poles	Part No.		Dimensions	
			A	B
8	WW4201-HC04x2	5557-2x4YC	12.6	18

1	Housing	PA66(UL94V-0/V-2)	1	White					
No.	Item/Material No.	Material	QTY	Remark					
Unmarked Tolerance		 Yueqing Hegxing Electronics Co., Ltd							
X. ° ±3° X. X° ±0.5°									
>0-3	>3-18	>18-50	>50-120	Unit	Scale	Design Unit	Size	Part No.	 
±0.12	±0.15	±0.3	±0.5	mm	—	Metric	A4		
Draw	Review	Approve	Material	Drawing No.			Part No.		
				Item	5557-NY				

5557 Type Housing

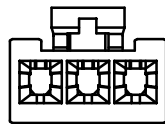
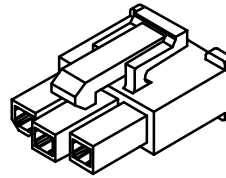
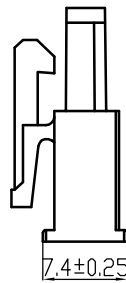
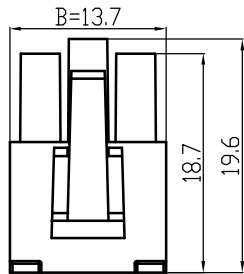
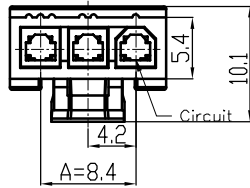

Poles	Part No.		Dimensions	
			A	B
3	WW4201-HD03	5557-3Y long & short leg	12.6	18

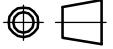
1	Housing	PA66(UL94V-0/V-2)	1	White					
No.	Item/Material No.	Material	QTY	Remark					
Unmarked Tolerance		 Yueqing Hegxing Electronics Co., Ltd							
X. ° ±3° X. X° ±0.5°									
>0-3	>3-18	>18-50	>50-120	Unit	Scale	Design Unit	Size	Part No.	
±0.12	±0.15	±0.3	±0.5	mm	—	Metric	A4		
Draw	Review	Approve	Material	Drawing No.	Part No.				
				Item	5557-3Y(long & short leg)-158				

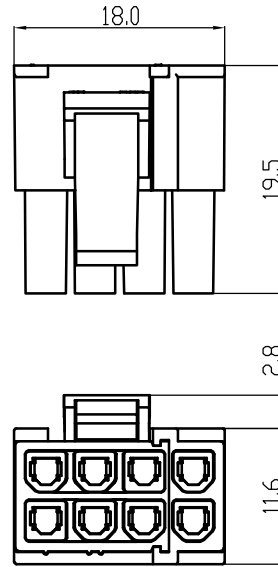
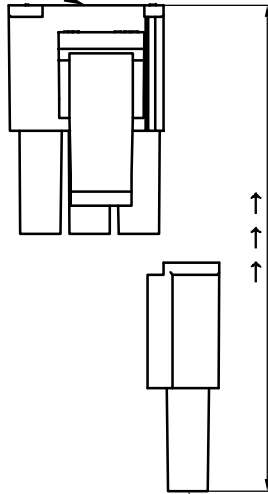
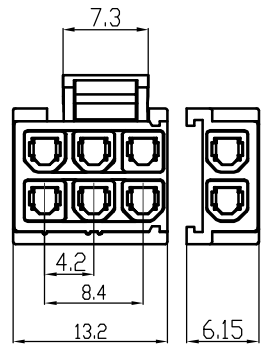

5557 Type Housing

5557-(6+2 combination)2*3Y

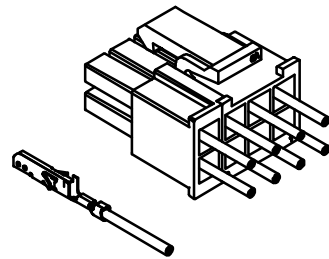
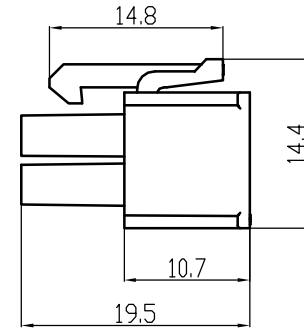

5557-(6+2 combination)2*1Y



1	Housing	PA66(UL94V-0/V-2)	2	White					
No.	Item/Material No.	Material	QTY	Remark					
Unmarked Tolerance		 Yueqing Hegxing Electronics Co., Ltd							
X. ° ±3° X. X° ±0.5°									
>0-3	>3-18	>18-50	>50-120	Unit	Scale	Design Unit	Size	Part No.	 
±0.12	±0.15	±0.3	±0.5	mm	—	Metric	A4		
Draw	Review	Approve	Material	Drawing No.	Part No.				
				Item	5557-6+2 combination				

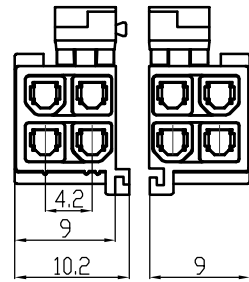
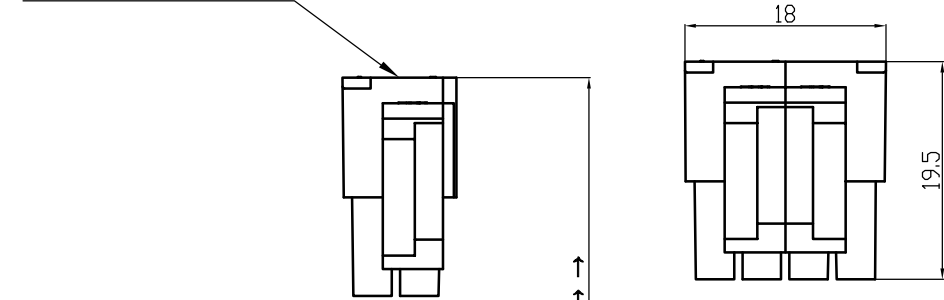

5557 Type Housing

5557-(4+4 combination)2*2YL



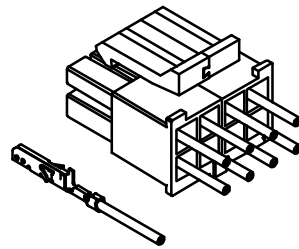
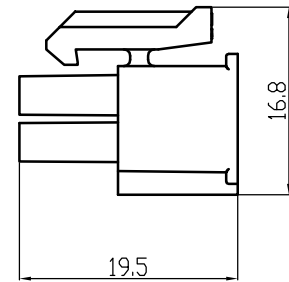



5557-(4+4 combination)2*2YR

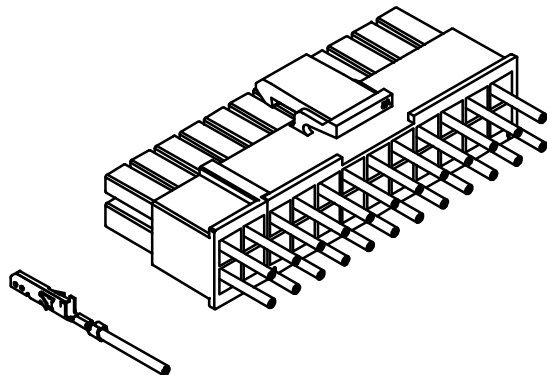
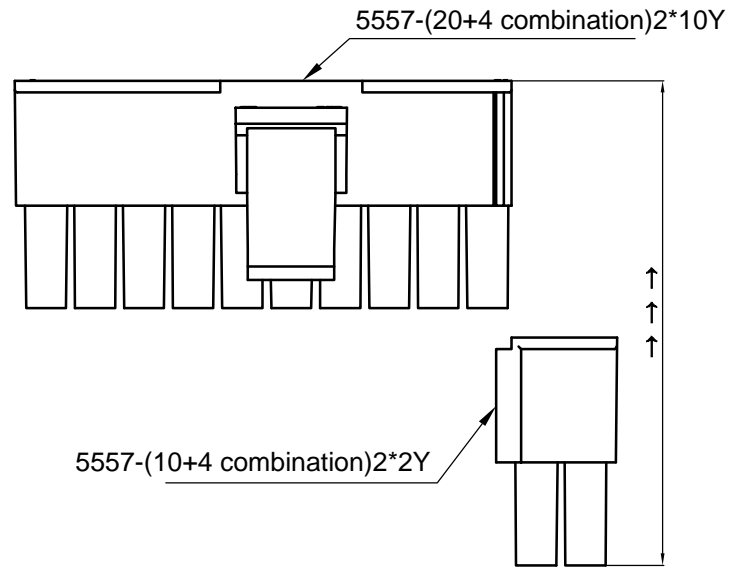
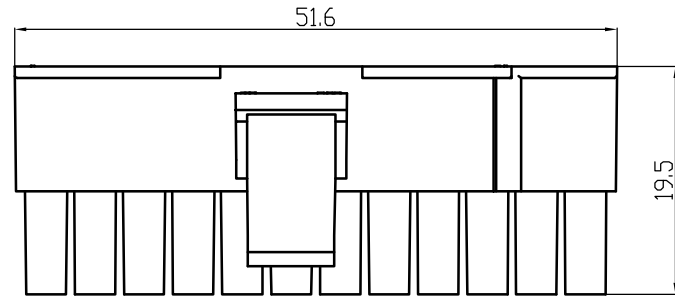
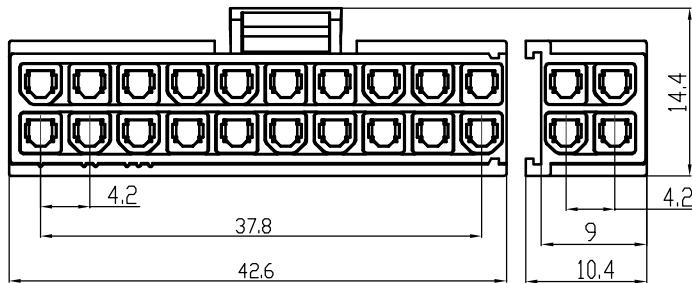
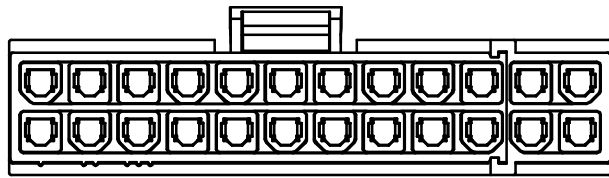

1	Housing	PA66(UL94V-0/V-2)	2	White					
No.	Item/Material No.	Material	QTY	Remark					
Unmarked Tolerance		 Yueqing Hegxing Electronics Co., Ltd							
X. ° ±3° X. X° ±0.5°									
>0-3	>3-18	>18-50	>50-120	Unit	Scale	Design Unit	Size	Part No.	 
±0.12	±0.15	±0.3	±0.5	mm	—	Metric	A4		
Draw	Review	Approve	Material	Drawing No.	Part No.				
				Item	5557-4+4 combination				



5557 Type Housing

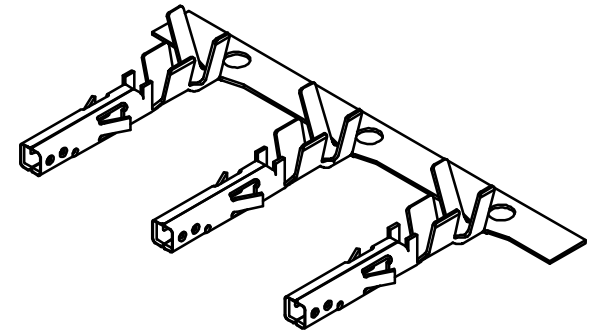
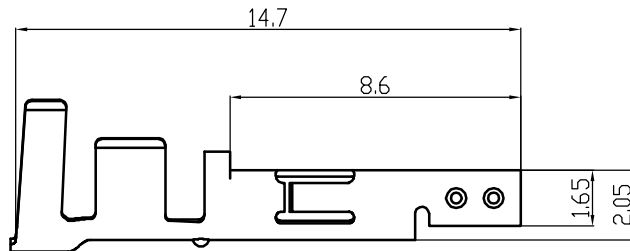
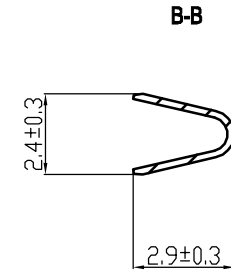
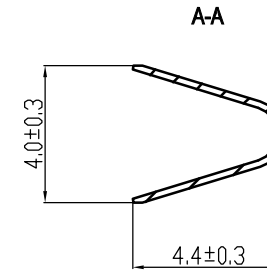
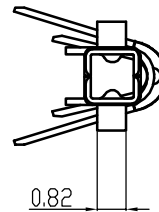
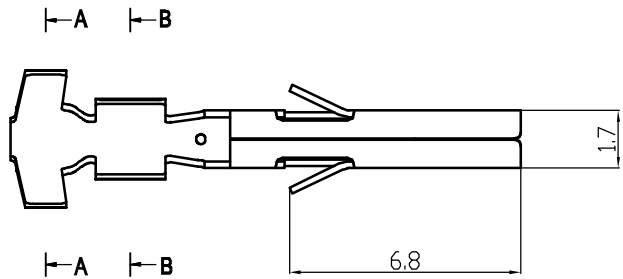

1	Housing	PA66(UL94V-0/V-2)	2	White					
No.	Item/Material No.	Material	QTY	Remark					
Unmarked Tolerance		 Yueqing Hegxing Electronics Co., Ltd							
X. ° ±3° X. X° ±0.5°									
>0-3	>3-18	>18-50	>50-120	Unit	Scale	Design Unit	Size	Part No.	 
±0.12	±0.15	±0.3	±0.5	mm	—	Metric	A4		
Draw	Review	Approve	Material	Drawing No.			Part No.		
				Item	5557-20+4 combination				

5557 Type Terminal



1	Terminal	Phosphor Bronze	1						
No.	Item/Material No.	Material	QTY	Remark					
Unmarked Tolerance		 Yueqing Hegxing Electronics Co., Ltd							
X. ° ±3°	X. X° ±0.5°								
>0-3	>3-18	>18-50	>50-120	Unit	Scale	Design Unit	Size	Part No.	 
±0.12	±0.15	±0.3	±0.5	mm	—	Metric	A4		
Draw	Review	Approve	Material	Drawing No.	Part No.				
				Item	5557-YT high leg				

5557 Type Terminal

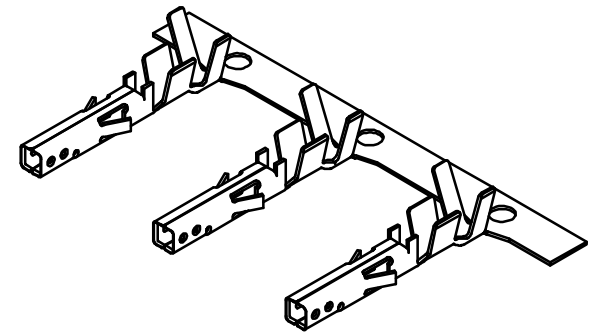
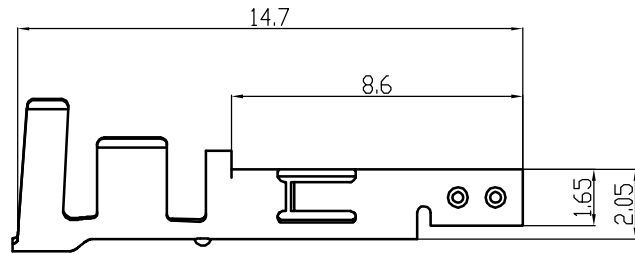
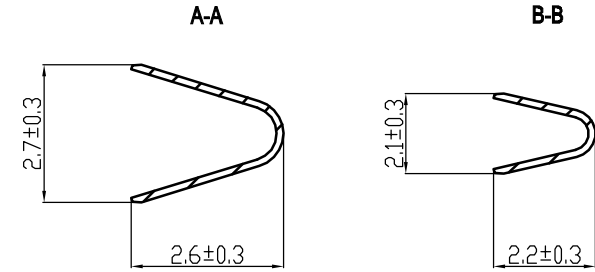
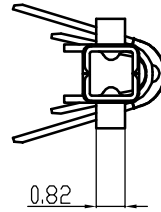
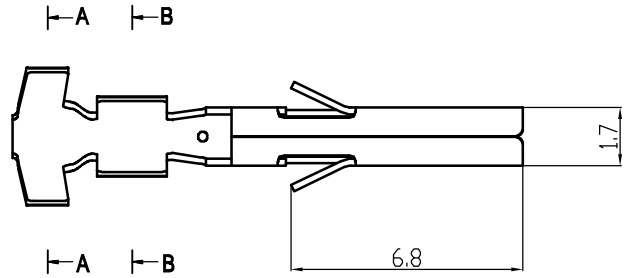

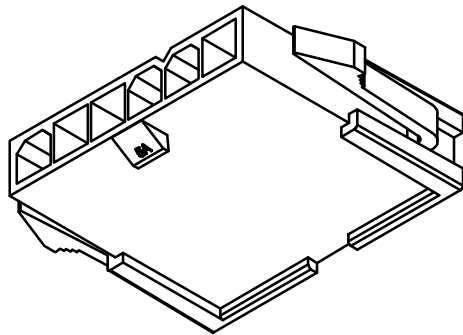
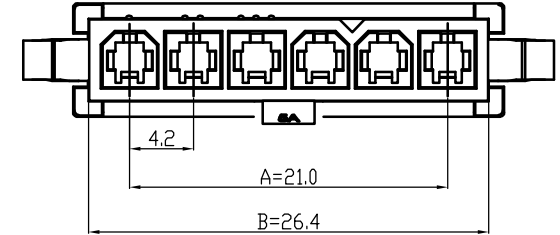
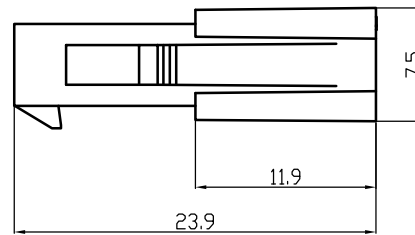
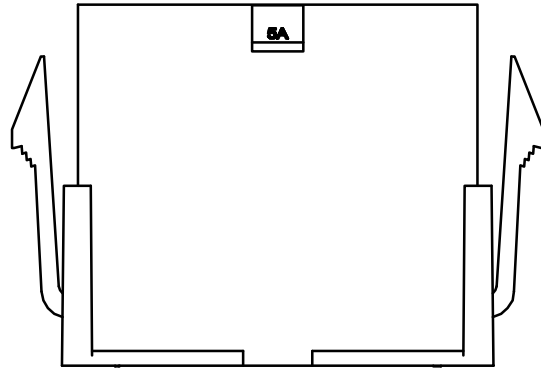
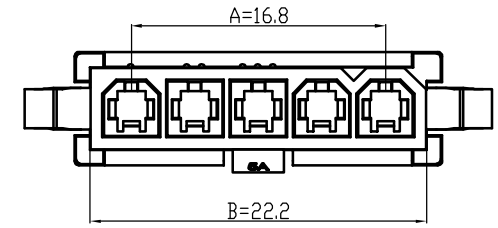
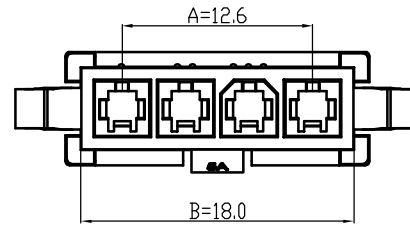
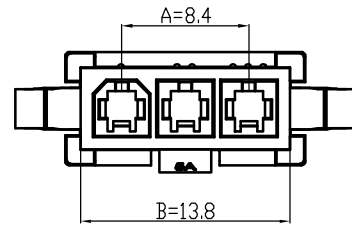
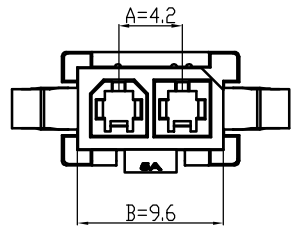

1	Terminal	Phosphor Bronze	1	
No.	Item/Material No.	Material	QTY	Remark
Unmarked Tolerance		 Yueqing Hegxing Electronics Co., Ltd		
X. ° ±3°	X. X ° ±0.5°			
>0-3	>3-18	>18-50	>50-120	
±0.12	±0.15	±0.3	±0.5	
Unit	Scale	Design Unit	Size	Part No.
mm	—	Metric	A4	
Draw	Review	Approve	Material	Drawing No.
			Item	5557-YT low leg

Receptacle Housing



Poles	Part No.		Dimensions	
			A	B
2	WW4202-H02	5559-2A	4.2	9.6
3	WW4202-H03	5559-3A	8.4	13.8
4	WW4202-H04	5559-4A	12.6	18
5	WW4202-H05	5559-5A	16.8	22.2
6	WW4202-H06	5559-6A	21	26.4

1	Receptacle Housing	PA9T (UL94V-0)	1						
No.	Item/Material No.	Material	QTY	Remark					
Unmarked Tolerance		 Yueqing Hegxing Electronics Co., Ltd							
X. ° ±3° X. X° ±0.5°									
>0-3	>3-18	>18-50	>50-120	Unit	Scale	Design Unit	Size	Part No.	 
±0.12	±0.15	±0.3	±0.5	mm	—	Metric	A4		
Draw	Review	Approve	Material	Drawing No.	Part No.				
				Item	5559-NA				

Receptacle Housing

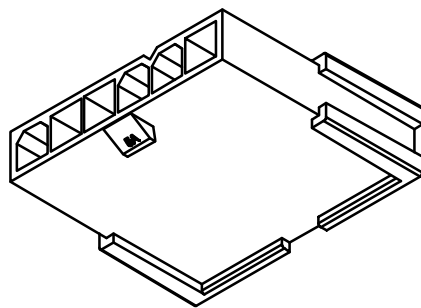
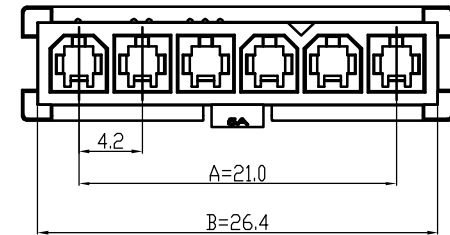
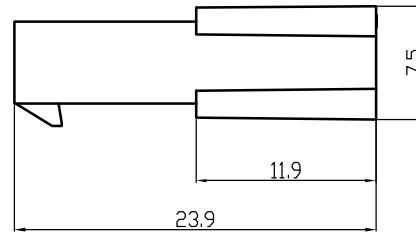
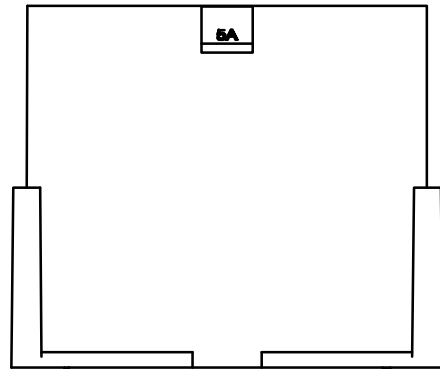
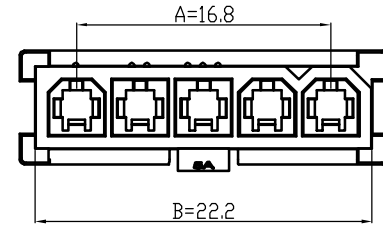
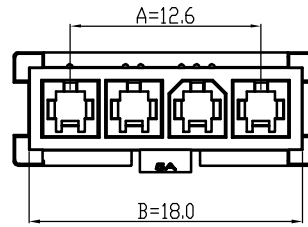
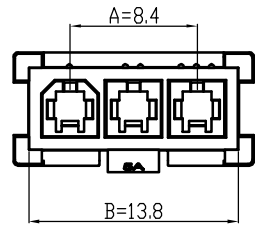
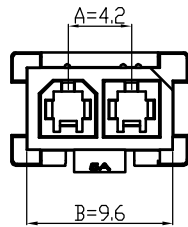



Poles	Part No.		Dimensions	
	A	B	A	B
2	WW4202-HB02	5559-2AF	4.2	9.6
3	WW4202-HB03	5559-3AF	8.4	13.8
4	WW4202-HB04	5559-4AF	12.6	18
5	WW4202-HB05	5559-5AF	16.8	22.2
6	WW4202-HB06	5559-6AF	21	26.4

1	Receptacle Housing	PA9T (UL94V-0)	1						
No.	Item/Material No.	Material	QTY	Remark					
Unmarked Tolerance		Yueqing Hegxing Electronics Co., Ltd							
X. ° ±3° X. X° ±0.5°									
>0-3	>3-18	>18-50	>50-120	Unit	Scale	Design Unit	Size	Part No.	
±0.12	±0.15	±0.3	±0.5	mm	—	Metric	A4		
Draw	Review	Approve	Material	Drawing No.			Part No.		
							Item	5559-NAF	

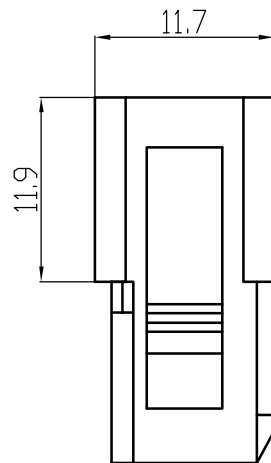
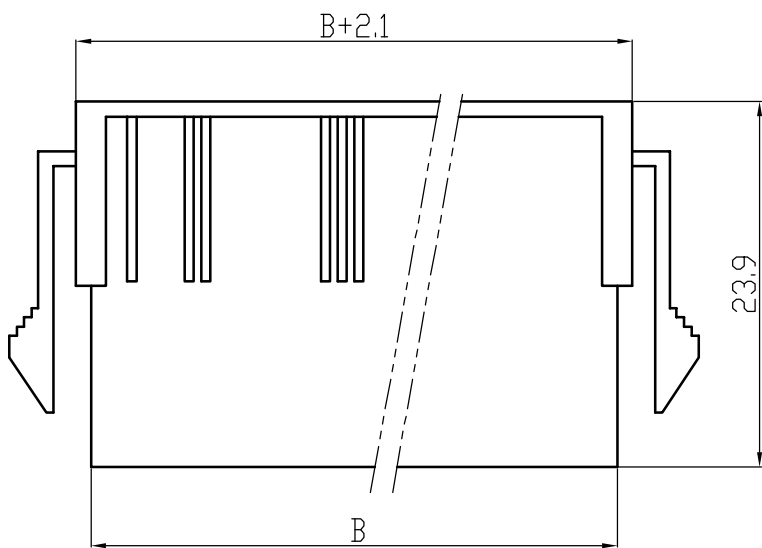
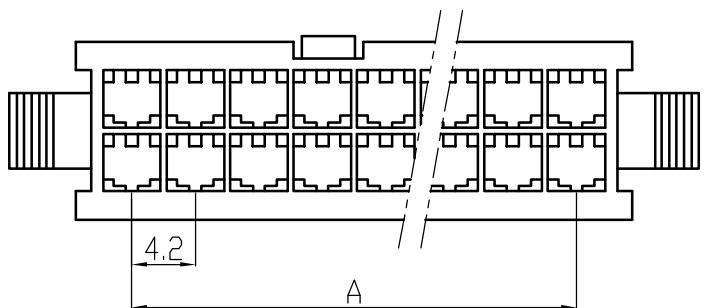
Receptacle Housing



Poles	Part No.		Dimensions	
			A	B
2	WW4202-H01x2	5559-2xx1A	-	5.4
4	WW4202-H02x2	5559-2xx2A	4.2	9.6
6	WW4202-H03x2	5559-2xx3A	8.4	13.8
8	WW4202-H04x2	5559-2xx4A	12.6	18
10	WW4202-H05x2	5559-2xx5A	16.8	22.2
12	WW4202-H06x2	5559-2xx6A	21	26.4
14	WW4202-H07x2	5559-2xx7A	25.2	30.6
16	WW4202-H08x2	5559-2xx8A	29.4	34.8
18	WW4202-H09x2	5559-2xx9A	33.6	39
20	WW4202-H10x2	5559-2xx10A	37.8	43.2
22	WW4202-H11x2	5559-2xx11A	42	47.4
24	WW4202-H12x2	5559-2xx12A	46.2	51.6

1	Receptacle Housing	PA9T (UL94V-0)	1						
No.	Item/Material No.	Material	QTY	Remark					
Unmarked Tolerance		 Yueqing Hegxing Electronics Co., Ltd							
X. ° ±3° X. X° ±0.5°									
>0-3	>3-18	>18-50	>50-120	Unit	Scale	Design Unit	Size	Part No.	 
±0.12	±0.15	±0.3	±0.5	mm	—	Metric	A4		
Draw	Review	Approve	Material	Drawing No.	Part No.				
				Item	5559-2xNA				

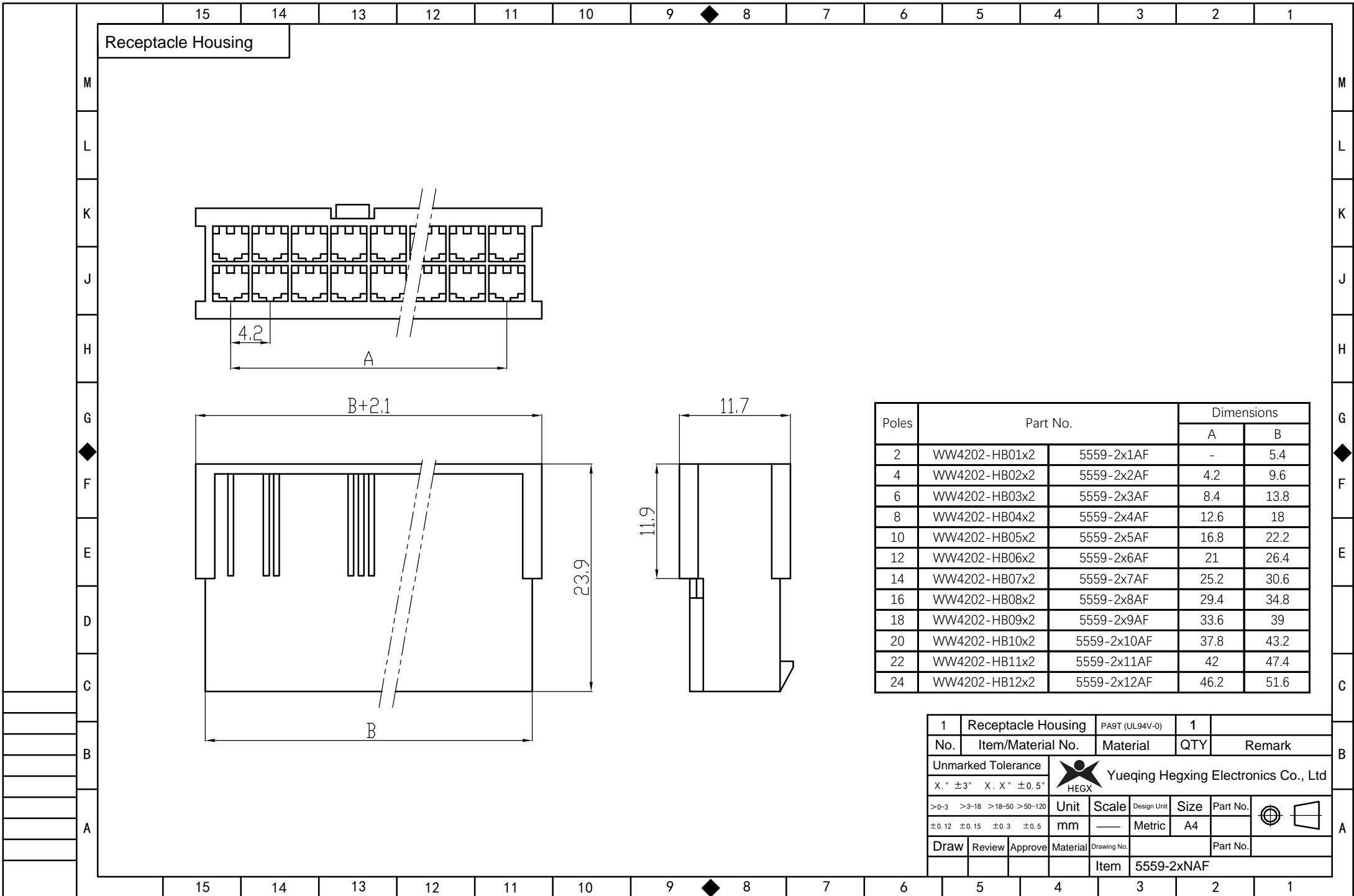

Poles	Part No.		Dimensions	
			A	B
2	WW4202-HB01x2	5559-2x1AF	-	5.4
4	WW4202-HB02x2	5559-2x2AF	4.2	9.6
6	WW4202-HB03x2	5559-2x3AF	8.4	13.8
8	WW4202-HB04x2	5559-2x4AF	12.6	18
10	WW4202-HB05x2	5559-2x5AF	16.8	22.2
12	WW4202-HB06x2	5559-2x6AF	21	26.4
14	WW4202-HB07x2	5559-2x7AF	25.2	30.6
16	WW4202-HB08x2	5559-2x8AF	29.4	34.8
18	WW4202-HB09x2	5559-2x9AF	33.6	39
20	WW4202-HB10x2	5559-2x10AF	37.8	43.2
22	WW4202-HB11x2	5559-2x11AF	42	47.4
24	WW4202-HB12x2	5559-2x12AF	46.2	51.6

1	Receptacle Housing	PA9T (UL94V-0)	1						
No.	Item/Material No.	Material	QTY	Remark					
Unmarked Tolerance		 Yueqing Hegxing Electronics Co., Ltd							
X. ° ±3° X. X° ±0.5°									
>0-3	>3-18	>18-50	>50-120	Unit	Scale	Design Unit	Size	Part No.	 
±0.12	±0.15	±0.3	±0.5	mm	—	Metric	A4		
Draw	Review	Approve	Material	Drawing No.	Part No.				
				Item	5559-2xNAF				

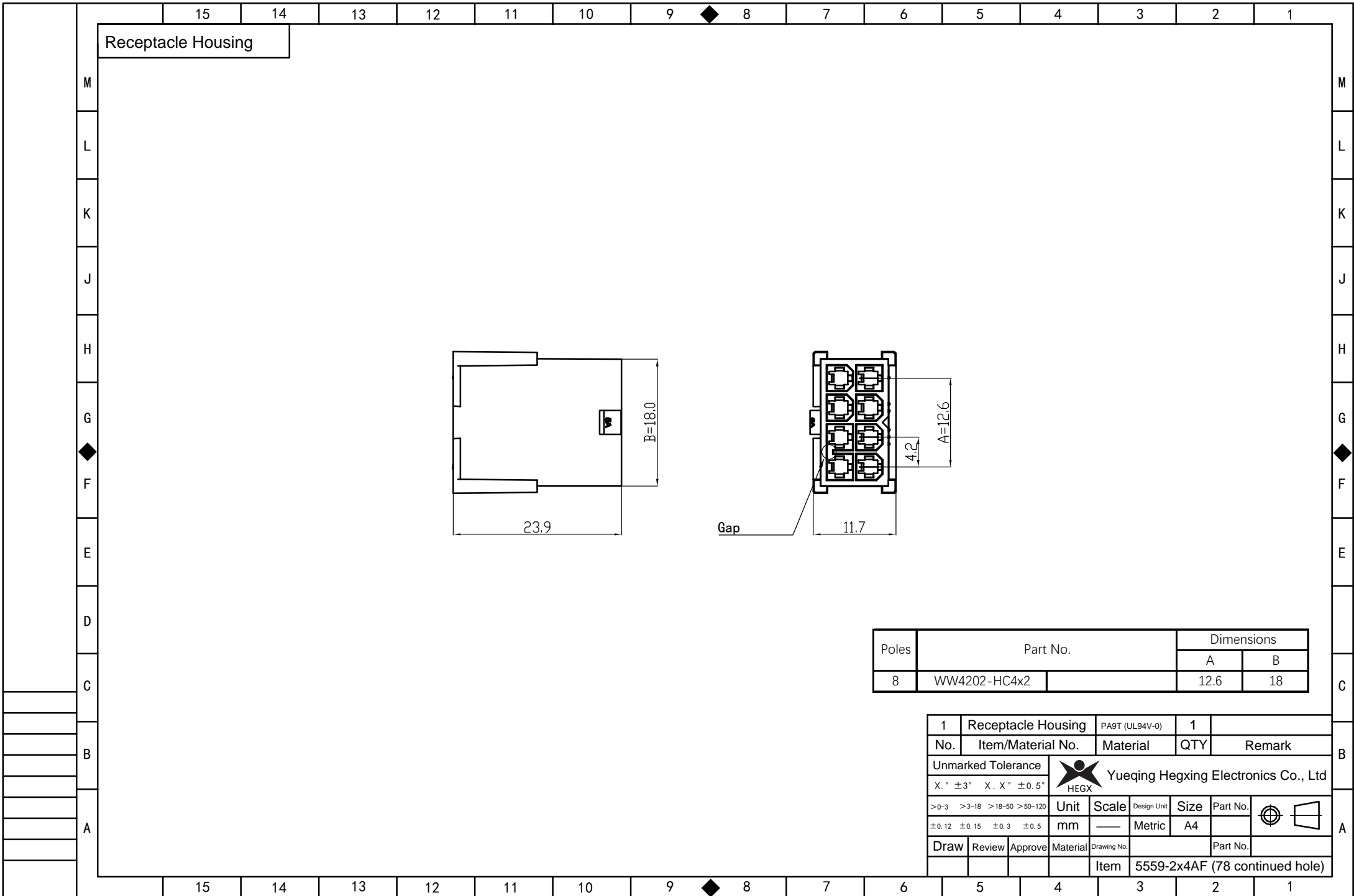

Poles	Part No.	Dimensions	
		A	B
8	WW4202-HC4x2	12.6	18

1	Receptacle Housing	PA9T (UL94V-0)	1						
No.	Item/Material No.	Material	QTY	Remark					
Unmarked Tolerance		Yueqing Hegxing Electronics Co., Ltd							
X. ° ±3° X. X° ±0.5°									
>0-3	>3-18	>18-50	>50-120	Unit	Scale	Design Unit	Size	Part No.	
±0.12	±0.15	±0.3	±0.5	mm	—	Metric	A4		
Draw	Review	Approve	Material	Drawing No.	Part No.				
			Item	5559-2x4AF (78 continued hole)					

Terminal

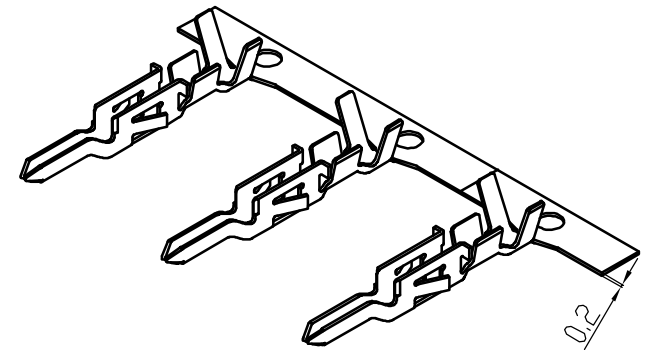
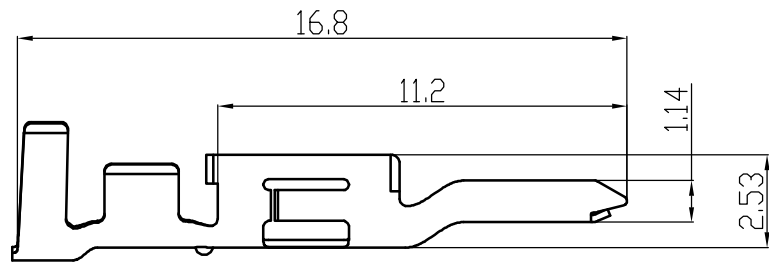
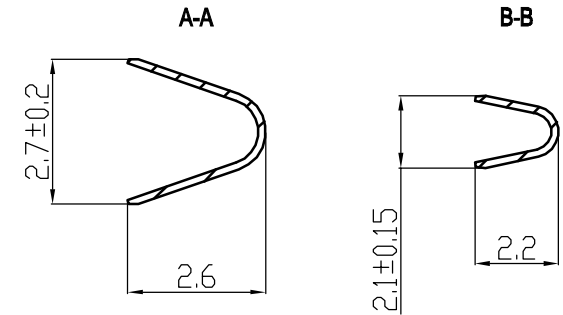
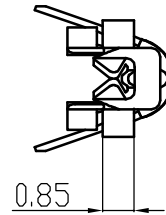
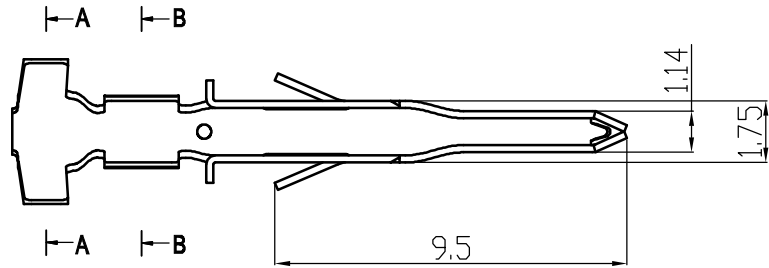

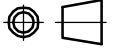
1	Terminal	Phospher Bronze	1						
No.	Item/Material No.	Material	QTY	Remark					
Unmarked Tolerance		 Yueqing Hegxing Electronics Co., Ltd							
X. ° ±3°	X. X° ±0.5°								
>0-3	>3-18	>18-50	>50-120	Unit	Scale	Design Unit	Size	Part No.	
±0.12	±0.15	±0.3	±0.5	mm	—	Metric	A4		
Draw	Review	Approve	Material	Drawing No.	Part No.				
				Item	5559-AT low leg				

Terminal

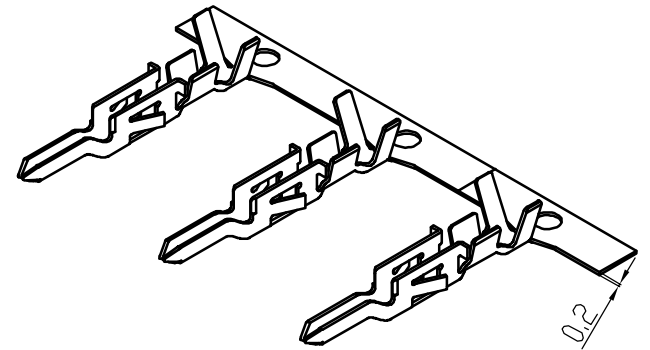
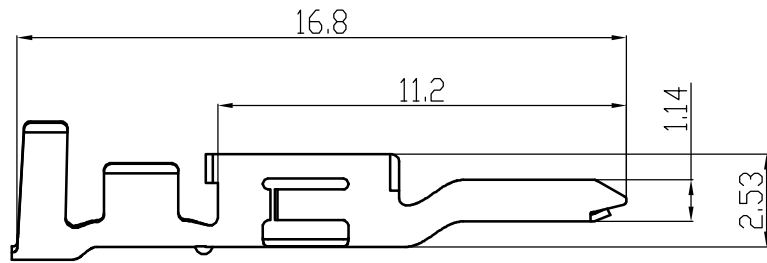
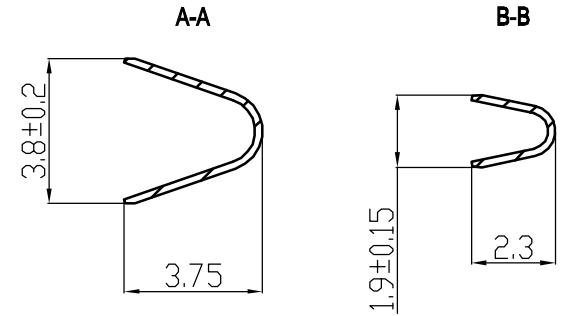
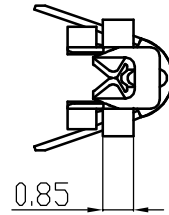
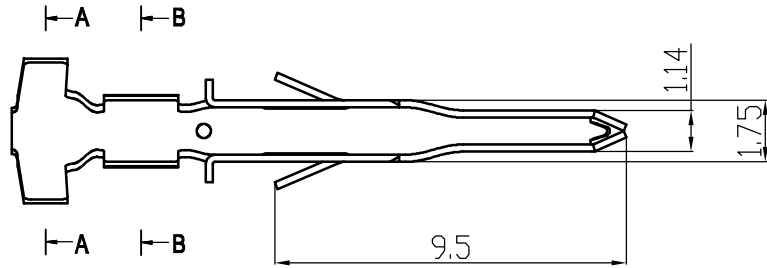

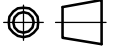
1	Terminal	Phospher Bronze	1						
No.	Item/Material No.	Material	QTY	Remark					
Unmarked Tolerance		 Yueqing Hegxing Electronics Co., Ltd							
X. ° ±3° X. X° ±0.5°									
>0-3	>3-18	>18-50	>50-120	Unit	Scale	Design Unit	Size	Part No.	
±0.12	±0.15	±0.3	±0.5	mm	—	Metric	A4		
Draw	Review	Approve	Material	Drawing No.	Part No.				
			Item	5559-AT high leg					