

Terminal

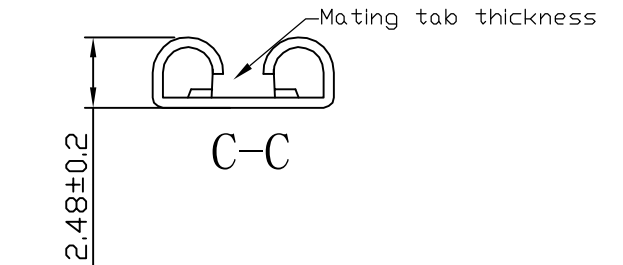

Part No.	Dimensions (mm)			Material Thickness	Mating Tab Thickness	Wire Range
	W	D	L	mm	mm	AWG
T480N-TA303	5.65	6	15.3	0.3	0.3	#24 ~ #20
T480N-TA305	5.65	6	15.3	0.3	0.5	#24 ~ #20
T480N-TA308	5.65	6	15.3	0.3	0.8	#24 ~ #20
T480N-TB303	5.65	6	15.3	0.3	0.3	#20 ~ #16
T480N-TB305	5.65	6	15.3	0.3	0.5	#20 ~ #16
T480N-TB306	5.65	6	15.3	0.3	0.6	#20 ~ #16
T480N-TB308	5.65	6	15.3	0.3	0.8	#20 ~ #16
T480N-TA353	5.65	6	15.3	0.35	0.3	#24 ~ #20
T480N-TB355	5.65	6	15.3	0.35	0.5	#20 ~ #16
T480N-TB358	5.65	6	15.3	0.35	0.8	#20 ~ #16
T480N-T12B353	5.65	6	15.3	0.35	0.3	#20 ~ #16

Item		Yueqing Hegxing Electronics Co., Ltd					
Tab-on Terminal		Unit	Scale	Design Unit	Size	Part No.	
187		mm	—	Metric	A4		
Draw	Review	Approve	Material	Drawing No.	Part No.		
			Material	Brass			

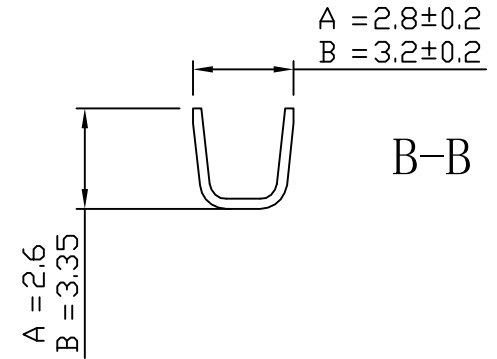
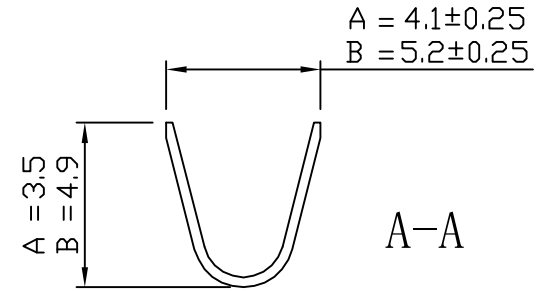
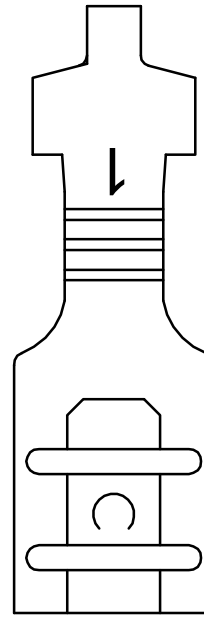
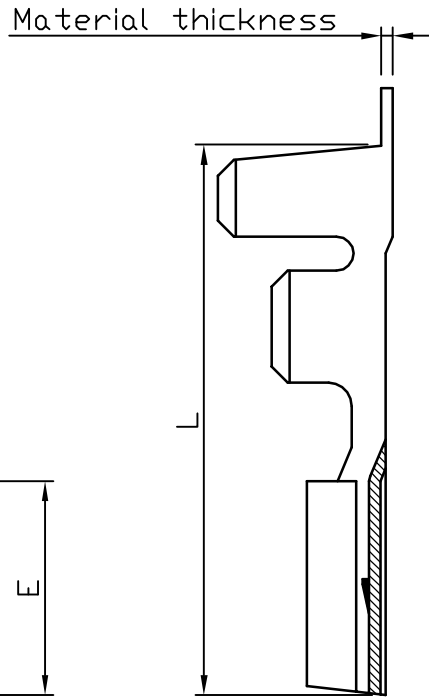
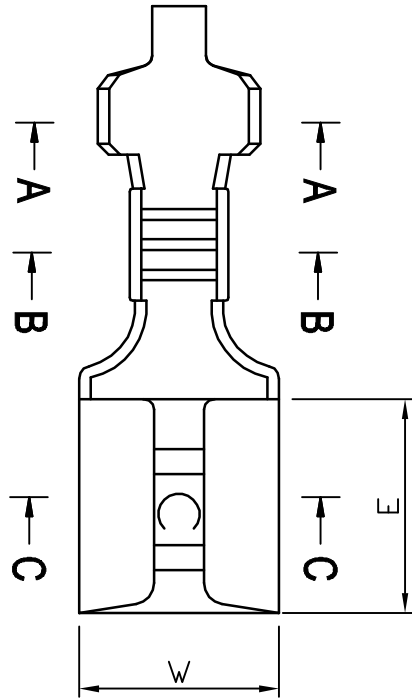
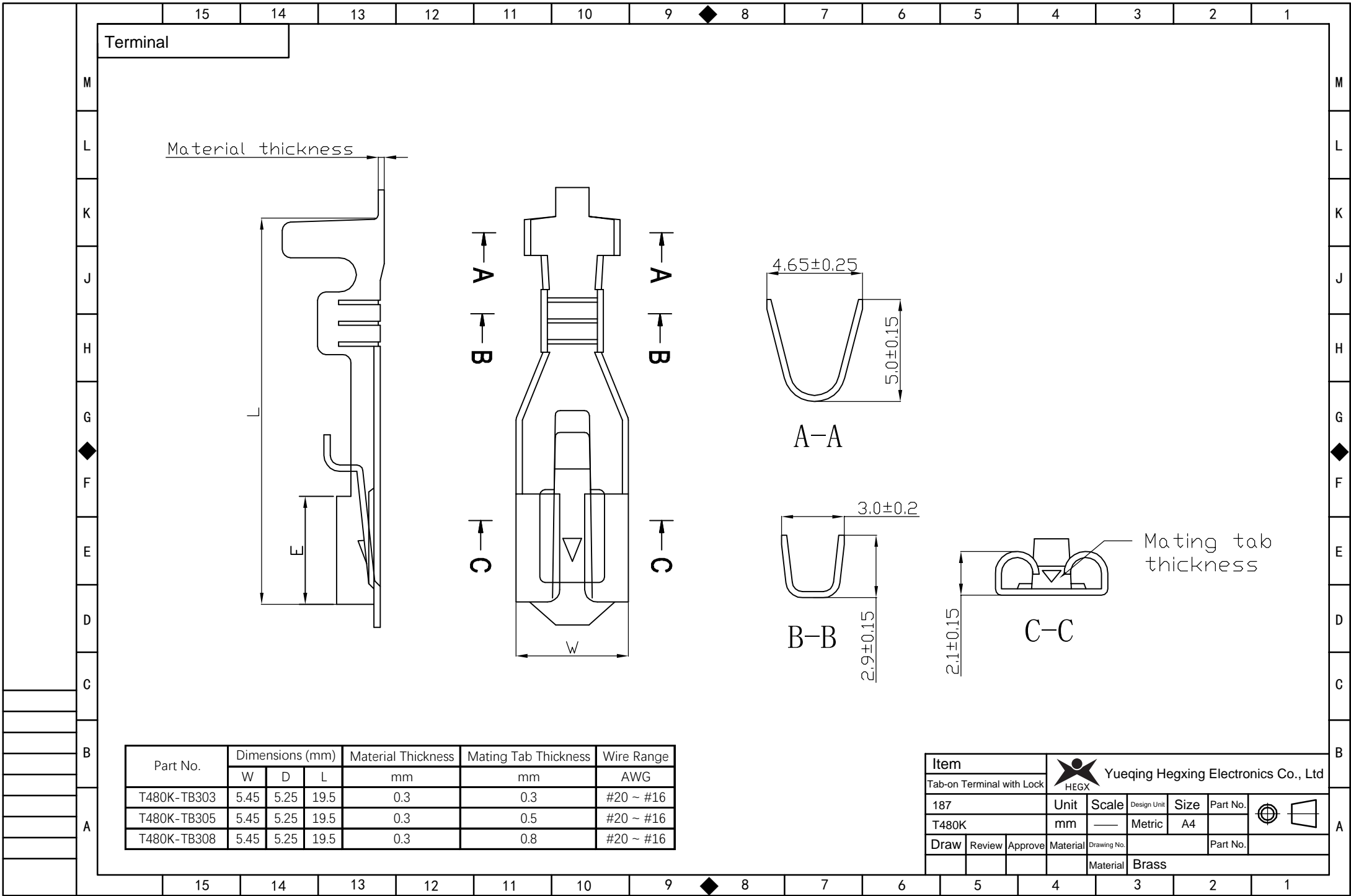

Part No.	Dimensions (mm)			Material Thickness	Mating Tab Thickness	Wire Range
	W	D	L	mm	mm	AWG
T480K-TB303	5.45	5.25	19.5	0.3	0.3	#20 ~ #16
T480K-TB305	5.45	5.25	19.5	0.3	0.5	#20 ~ #16
T480K-TB308	5.45	5.25	19.5	0.3	0.8	#20 ~ #16

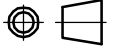
Item		 Yueqing Hegxing Electronics Co., Ltd				
Tab-on Terminal with Lock		Unit	Scale	Design Unit	Size	Part No.
187		mm	—	Metric	A4	
T480K		Material		Drawing No.	Part No.	
Draw	Review	Approve	Material		Brass	