

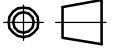

| | | | | | | | | | | | | | | |
|------|-----|-----|-----|------|------|------|------|------|------|------|------|------|------|------|
| B | 6 | 8.5 | 11 | 13.5 | 16 | 18.5 | 21 | 23.5 | 26 | 28.5 | 31 | 33.5 | 36 | 38.5 |
| A | 2.5 | 5 | 7.5 | 10 | 12.5 | 15 | 17.5 | 20 | 22.5 | 25 | 27.5 | 30 | 32.5 | 35 |
| Pole | 2 | 3 | 4 | 5 | 6 | 7 | 8 | 9 | 10 | 11 | 12 | 13 | 14 | 15 |

| | | | | | | | | |
|--------------|--|--|---------|-------------|------|----------------|---|--|
| Item | |  Yueqing Hegxing Electronics Co., Ltd | | | | | | |
| Plug Housing | | Unit | Scale | Design Unit | Size | Part No. |  | |
| 250 | | mm | — | Metric | A4 | | | |
| WB25018-Y | | Material | | Drawing No. | | Part No. | | |
| Draw | | Review | Approve | Material | | PA66 (UL94V-0) | | |

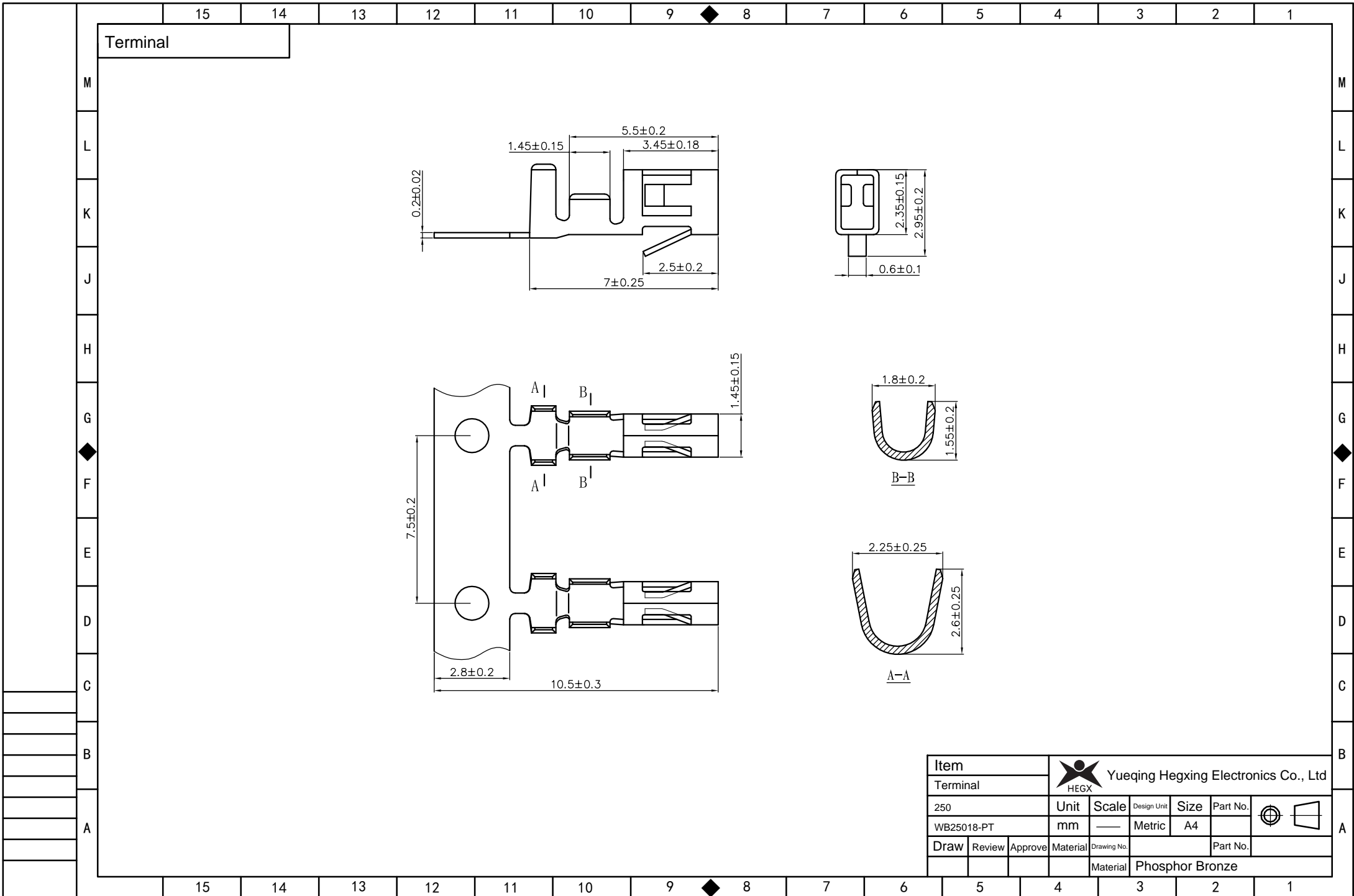

| | | | | | | | |
|----------|--------|--|----------|-----------------|----------|----------|---|
| Item | |  Yueqing Hegxing Electronics Co., Ltd | | | | | |
| Terminal | | Unit | Scale | Design Unit | Size | Part No. |  |
| 250 | | mm | — | Metric | A4 | | |
| Draw | Review | Approve | Material | Drawing No. | Part No. | | |
| | | | Material | Phosphor Bronze | | | |

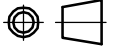
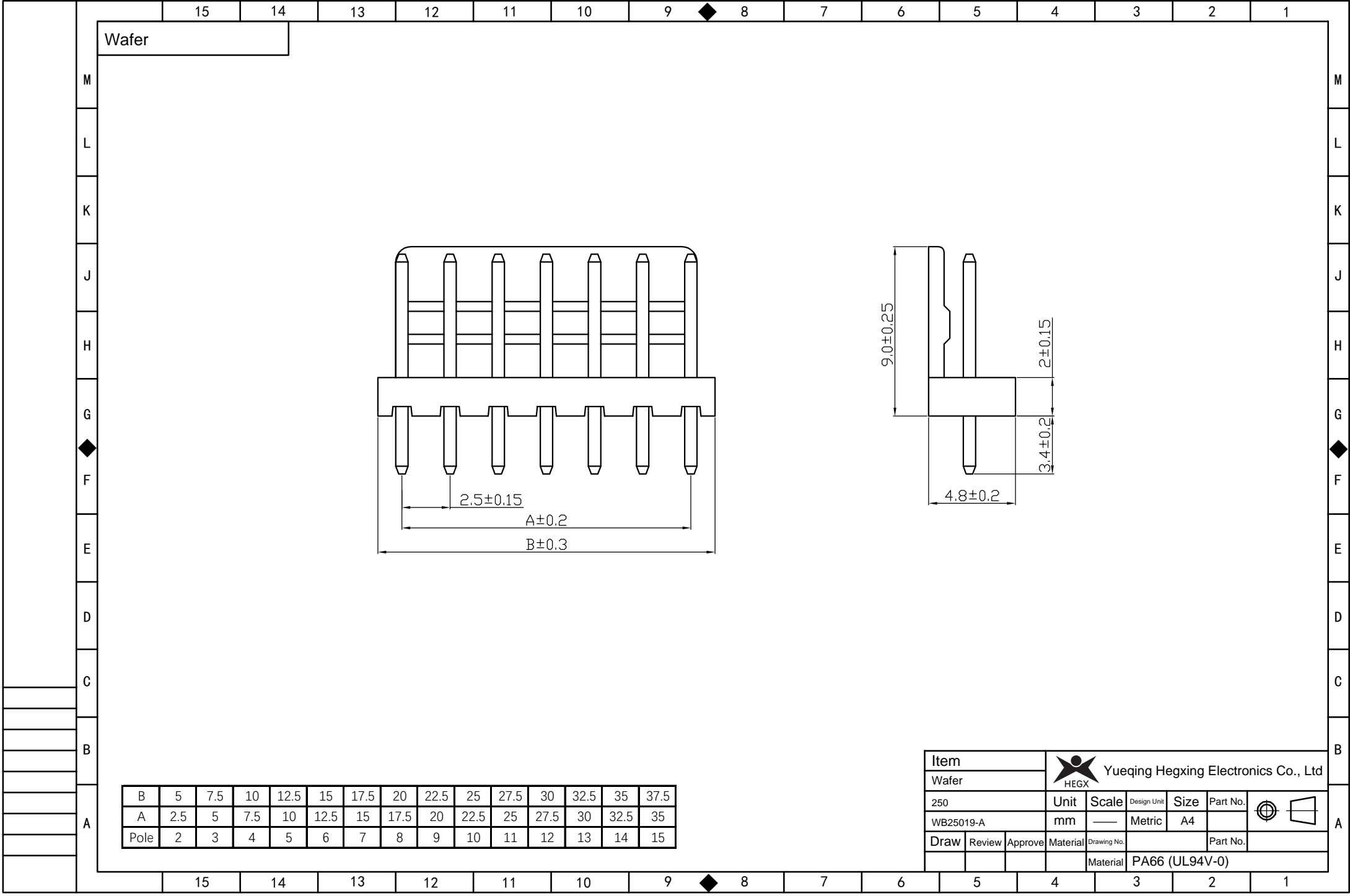

Wafer

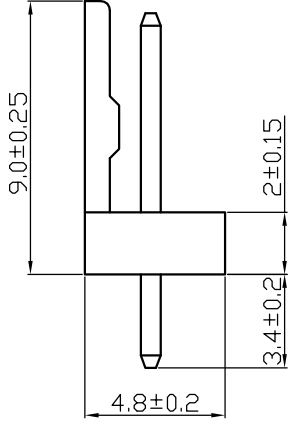
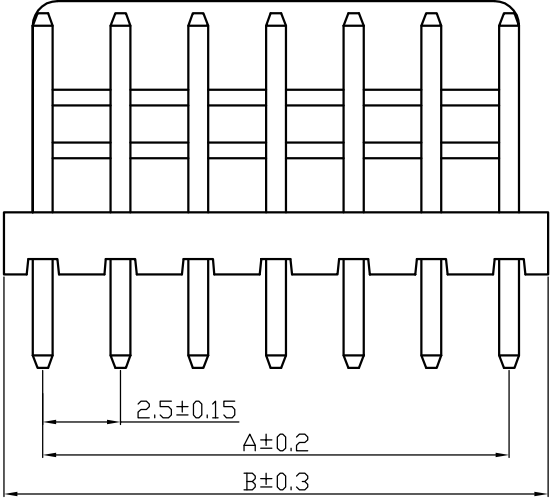

| | | | | | | | | | | | | | | |
|------|-----|-----|-----|------|------|------|------|------|------|------|------|------|------|------|
| B | 5 | 7.5 | 10 | 12.5 | 15 | 17.5 | 20 | 22.5 | 25 | 27.5 | 30 | 32.5 | 35 | 37.5 |
| A | 2.5 | 5 | 7.5 | 10 | 12.5 | 15 | 17.5 | 20 | 22.5 | 25 | 27.5 | 30 | 32.5 | 35 |
| Pole | 2 | 3 | 4 | 5 | 6 | 7 | 8 | 9 | 10 | 11 | 12 | 13 | 14 | 15 |

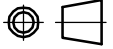
| | | | | | | | | | | | |
|-------|--------|--|----------|-------------|----------------|----------|---|--|--|--|--|
| Item | |  Yueqing Hegxing Electronics Co., Ltd | | | | | | | | | |
| Wafer | | Unit | Scale | Design Unit | Size | Part No. |  | | | | |
| 250 | | mm | — | Metric | A4 | | | | | | |
| Draw | Review | Approve | Material | Drawing No. | Part No. | | | | | | |
| | | | | Material | PA66 (UL94V-0) | | | | | | |

15 14 13 12 11 10 9 8 7 6 5 4 3 2 1

Wafer

M
L
K
J
H
G
F
E
D
C
B
A

M
L
K
J
H
G
F
E
D
C
B
A

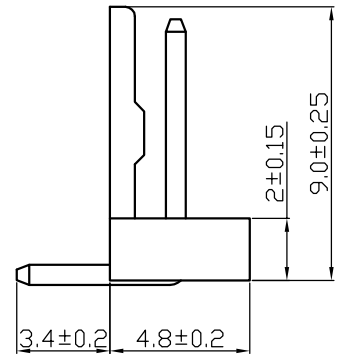
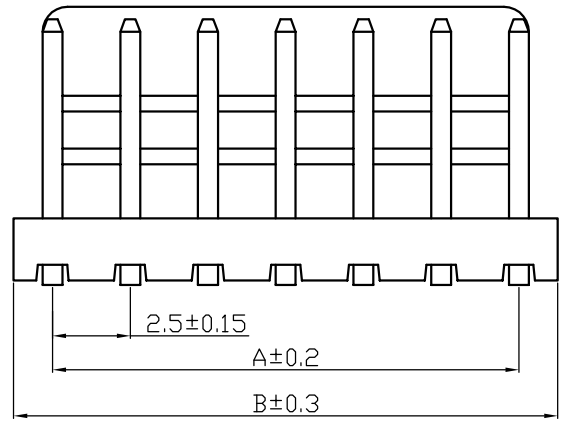

| | | | | | | | | | | | | | | |
|------|-----|-----|-----|------|------|------|------|------|------|------|------|------|------|------|
| B | 5 | 7.5 | 10 | 12.5 | 15 | 17.5 | 20 | 22.5 | 25 | 27.5 | 30 | 32.5 | 35 | 37.5 |
| A | 2.5 | 5 | 7.5 | 10 | 12.5 | 15 | 17.5 | 20 | 22.5 | 25 | 27.5 | 30 | 32.5 | 35 |
| Pole | 2 | 3 | 4 | 5 | 6 | 7 | 8 | 9 | 10 | 11 | 12 | 13 | 14 | 15 |

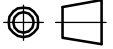
| | | | | | | | | | | | | | | |
|-------|--------|--|----------|-------------|----------|-------------------------|---|--|--|--|--|--|--|--|
| Item | |  Yueqing Hegxing Electronics Co., Ltd | | | | | | | | | | | | |
| Wafer | | Unit | Scale | Design Unit | Size | Part No. |  | | | | | | | |
| 250 | | mm | — | Metric | A4 | | | | | | | | | |
| Draw | Review | Approve | Material | Drawing No. | Part No. | | | | | | | | | |
| | | | | | | Material PA66 (UL94V-0) | | | | | | | | |

15 14 13 12 11 10 9 8 7 6 5 4 3 2 1