

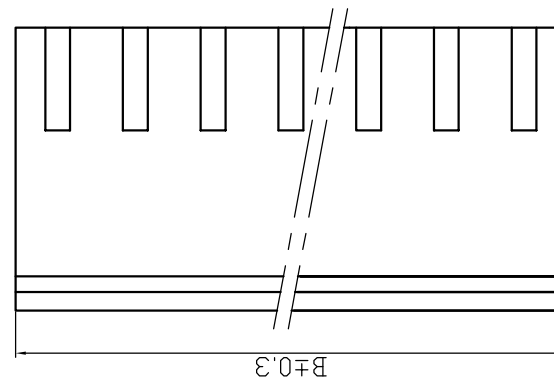

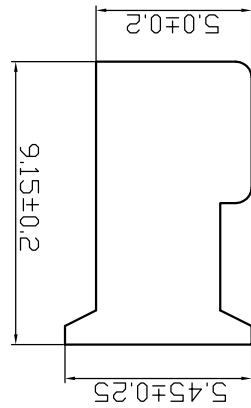

Plug Housing

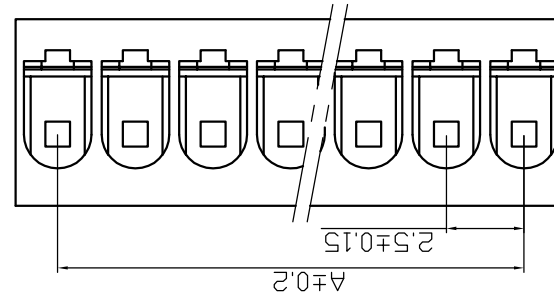

B	5.2	7.7	10.2	12.7	15.2	17.7	20.2	22.7	25.2	27.7	30.2
A	2.5	5	7.5	10	12.5	15	17.5	20	22.5	25	27.5
Pole	2	3	4	5	6	7	8	9	10	11	12

Item		 Yueqing Hegxing Electronics Co., Ltd									
Plug Housing											
S11	Unit	Scale	Design Unit	Size	Part No.	 					
WB25032-Y	mm	—	Metric	A4							
Draw	Review	Approve	Material	Drawing No.	Part No.						
					Material PA66 (UL94V-0)						

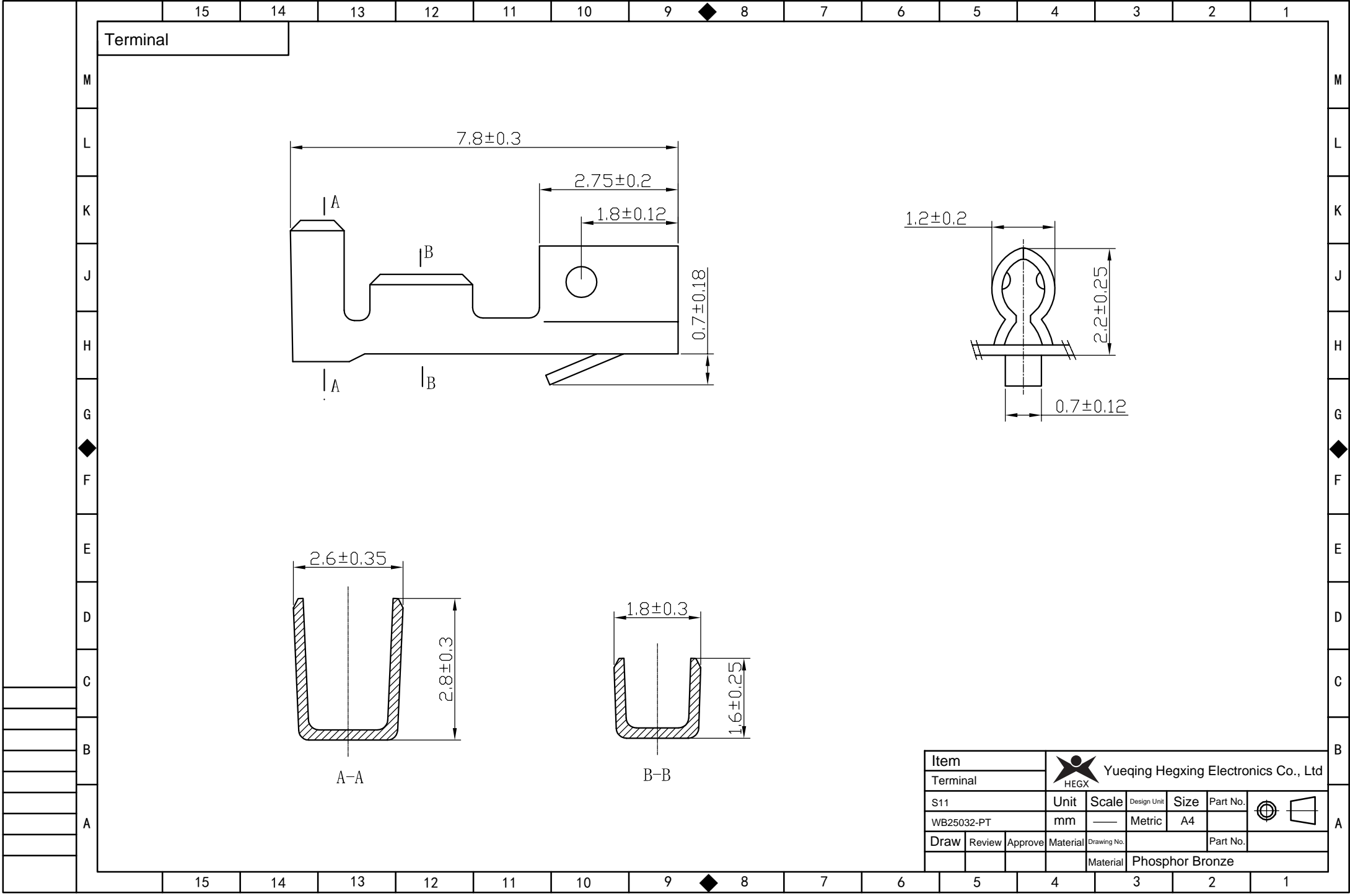

Terminal

Item		 Yueqing Hegxing Electronics Co., Ltd				
Terminal		Unit	Scale	Design Unit	Size	Part No.
S11		mm	—	Metric	A4	
WB25032-PT						
Draw	Review	Approve	Material	Drawing No.	Part No.	
			Material	Phosphor Bronze		

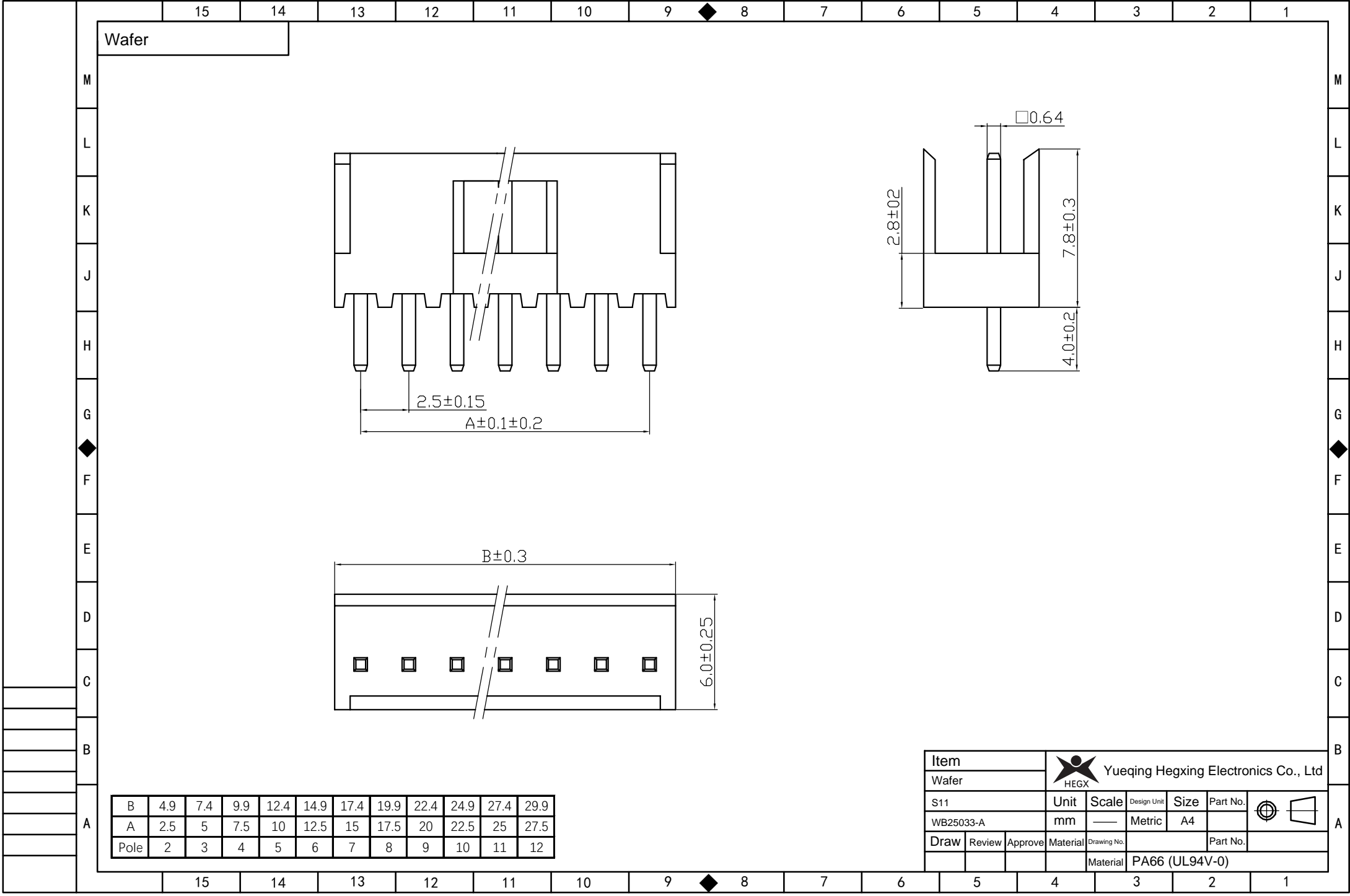

B	4.9	7.4	9.9	12.4	14.9	17.4	19.9	22.4	24.9	27.4	29.9
A	2.5	5	7.5	10	12.5	15	17.5	20	22.5	25	27.5
Pole	2	3	4	5	6	7	8	9	10	11	12

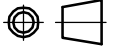
Item		 Yueqing Hegxing Electronics Co., Ltd					
Wafer		Unit	Scale	Design Unit	Size	Part No.	
S11		mm	—	Metric	A4		
Draw	Review	Approve	Material	Drawing No.		Part No.	
			Material	PA66 (UL94V-0)			

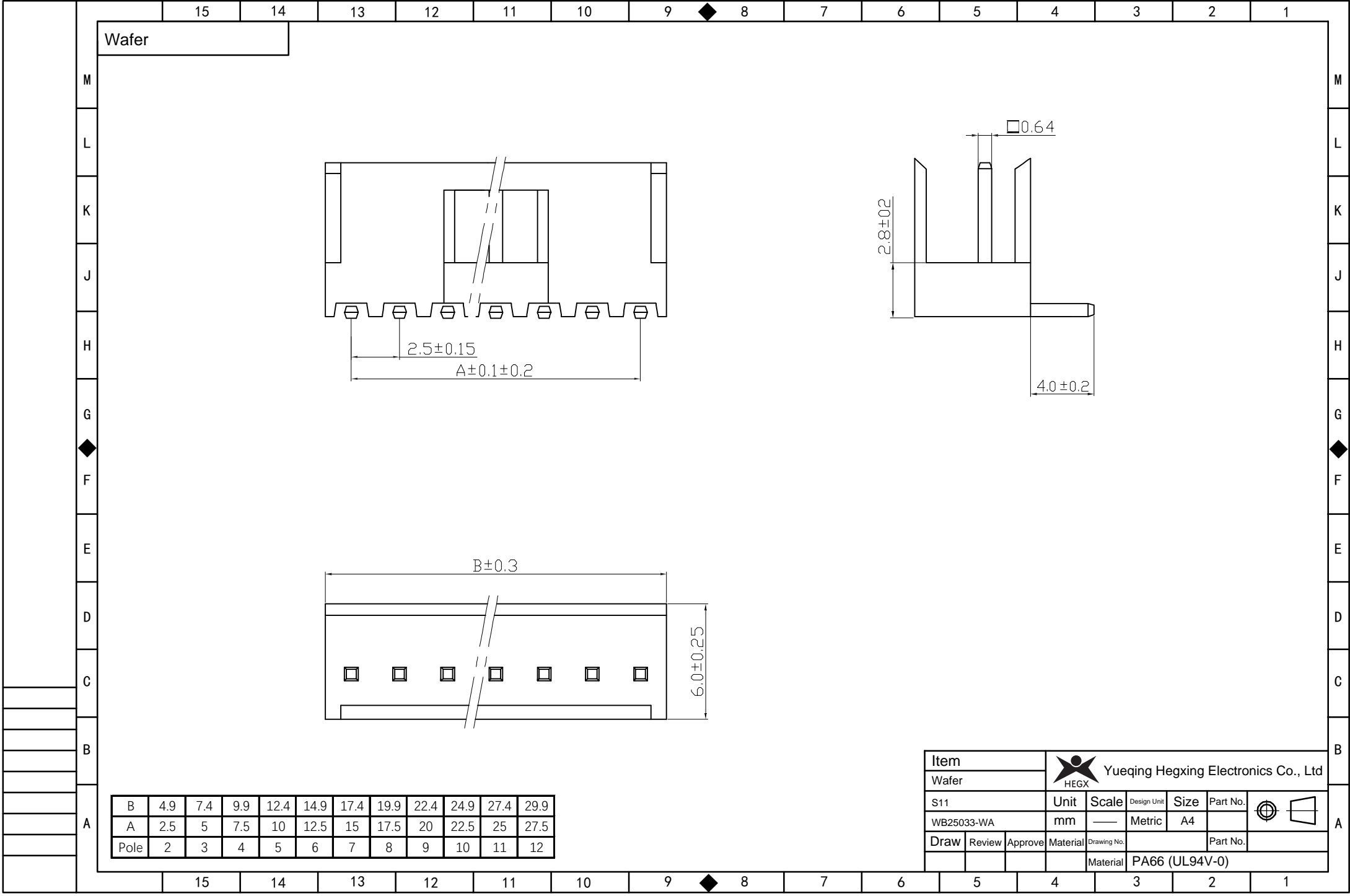

Wafer

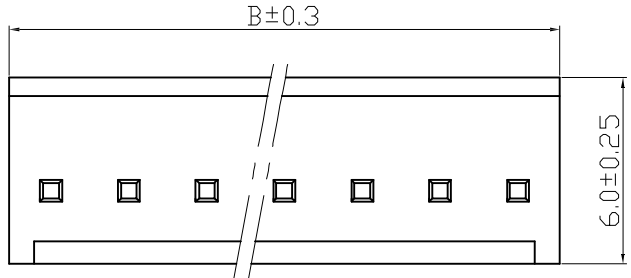
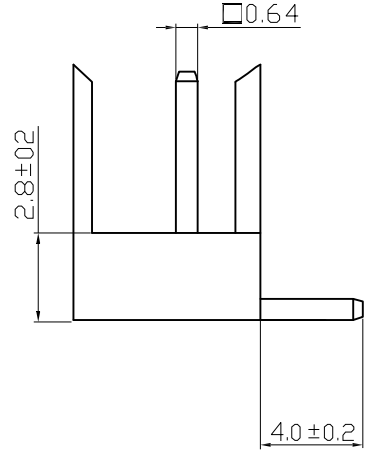
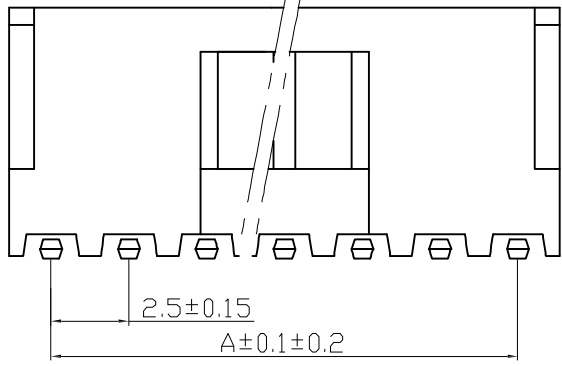

B	4.9	7.4	9.9	12.4	14.9	17.4	19.9	22.4	24.9	27.4	29.9
A	2.5	5	7.5	10	12.5	15	17.5	20	22.5	25	27.5
Pole	2	3	4	5	6	7	8	9	10	11	12

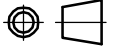
Item		 Yueqing Hegxing Electronics Co., Ltd									
Wafer		Unit	Scale	Design Unit	Size	Part No.					
S11		mm	—	Metric	A4						
WB25033-WA											
Draw	Review	Approve	Material	Drawing No.	Part No.						
					Material PA66 (UL94V-0)						