

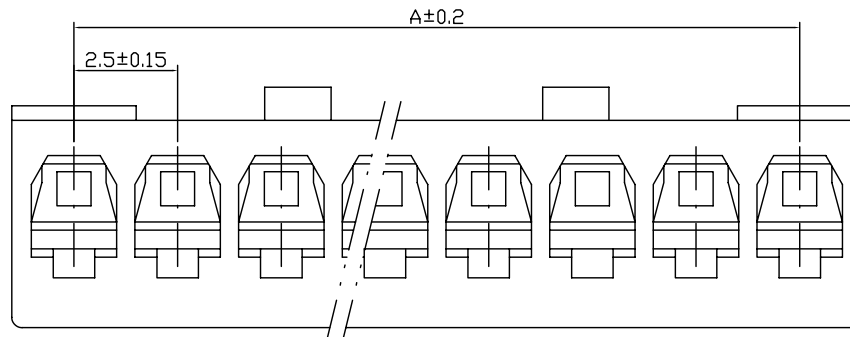

Plug Housing

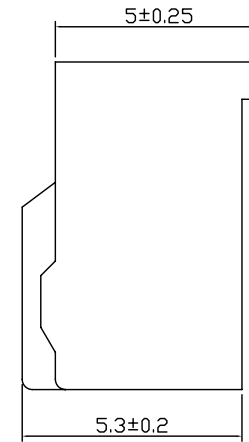

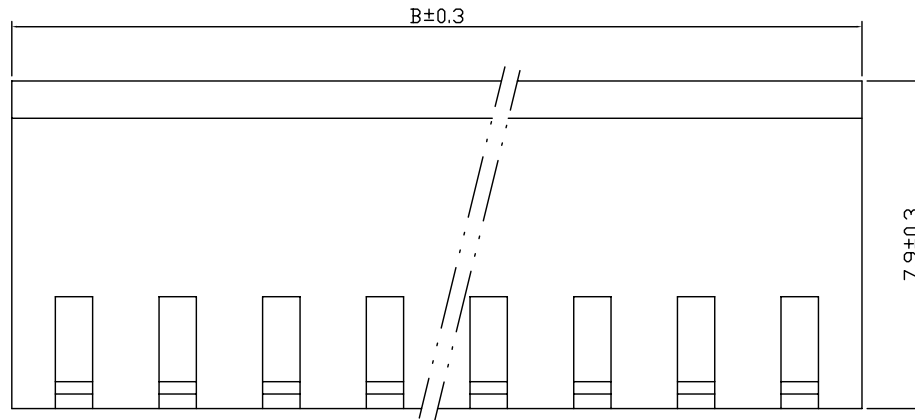

B	5.5	8	10.5	13	15.5	18	20.5	23	25.5	28	30.5
A	2.5	5	7.5	10	12.5	15	17.5	20	22.5	25	27.5
Pole	2	3	4	5	6	7	8	9	10	11	12

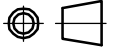
Item		 Yueqing Hegxing Electronics Co., Ltd									
Plug Housing		Unit	Scale	Design Unit	Size	Part No.					
LGC		mm	—	Metric	A4						
Draw	Review	Approve	Material	Drawing No.	Part No.						
			Material	PA66 (UL94V-0)							

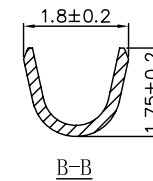
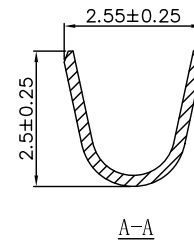
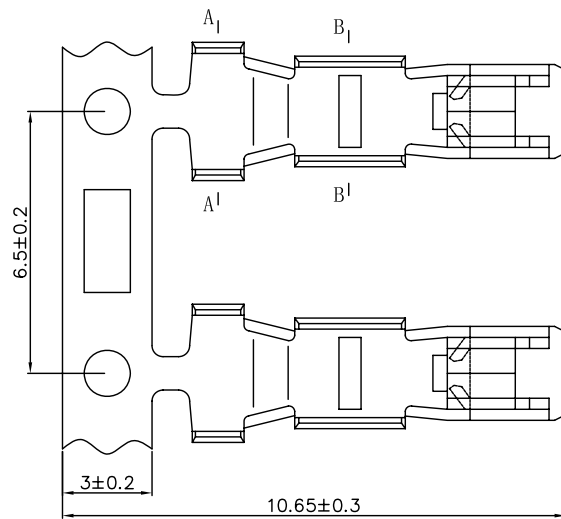
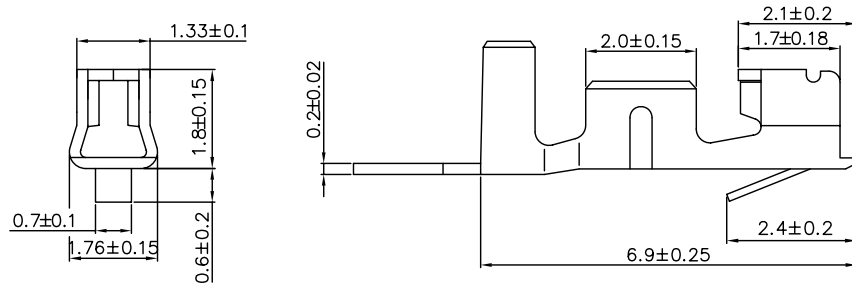
Terminal



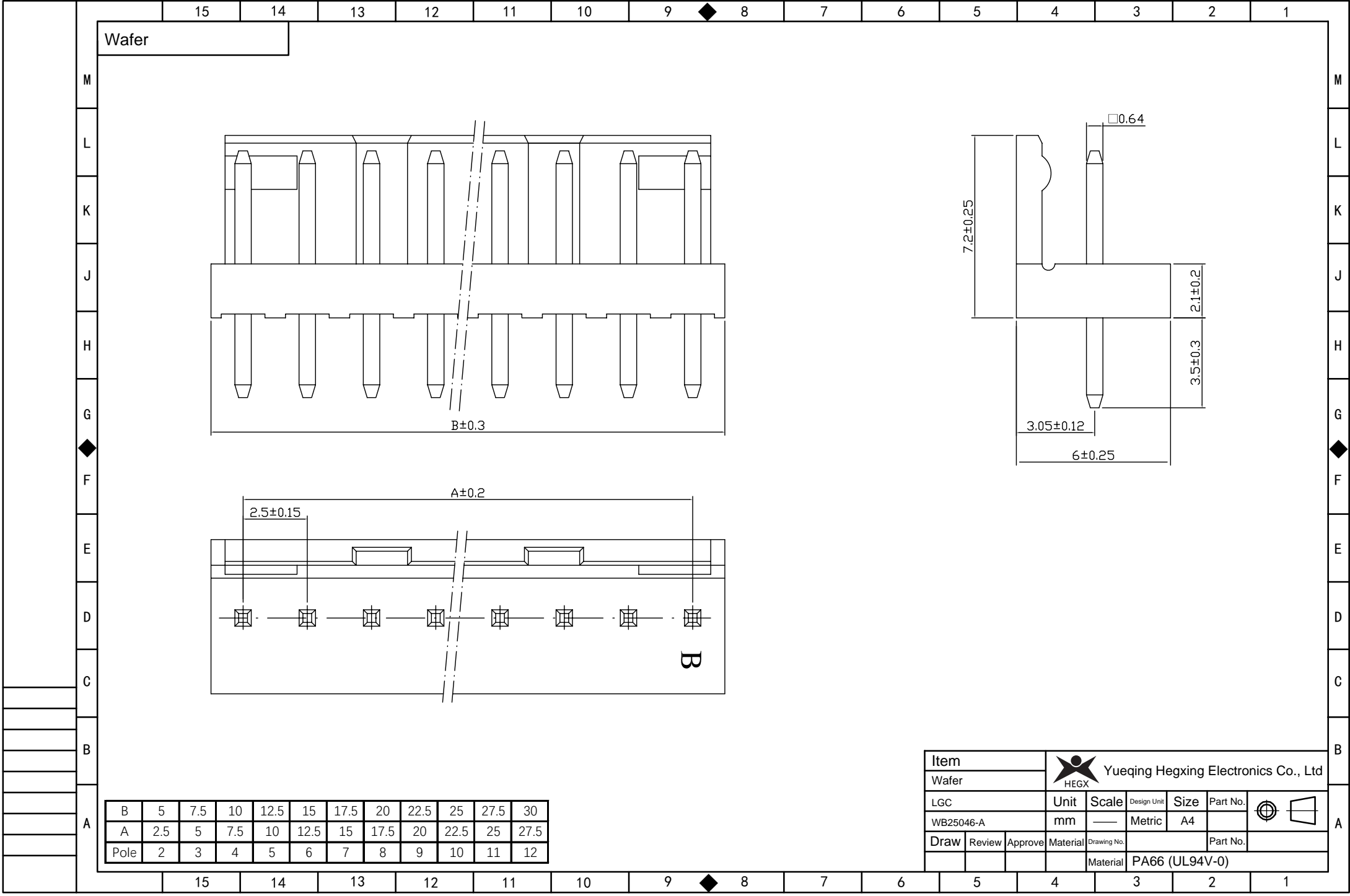

Item		 Yueqing Hegxing Electronics Co., Ltd				
Terminal		Unit	Scale	Design Unit	Size	Part No.
LGC		mm	—	Metric	A4	 
WB25045-PT		Material	Drawing No.	Part No.		
Draw	Review	Approve	Material	Phosphor Bronze		

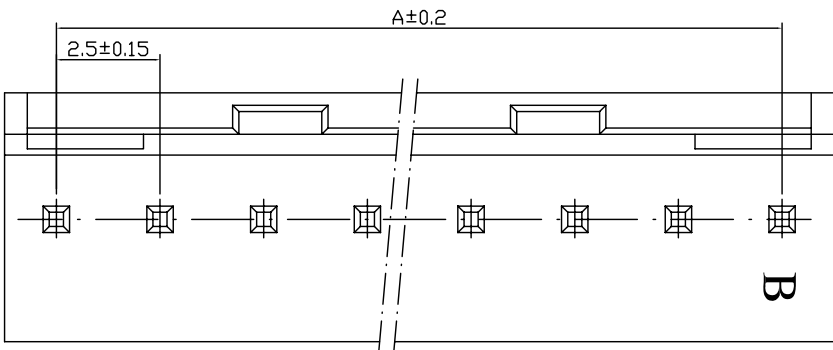
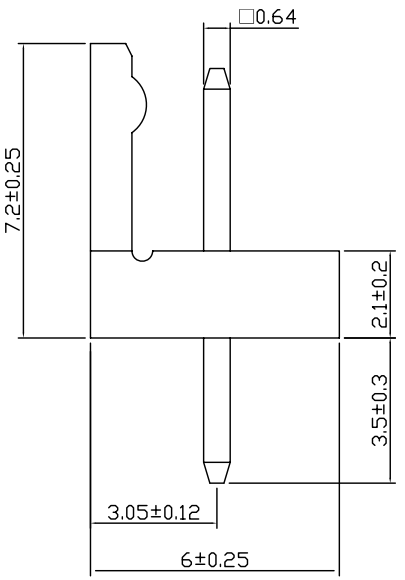
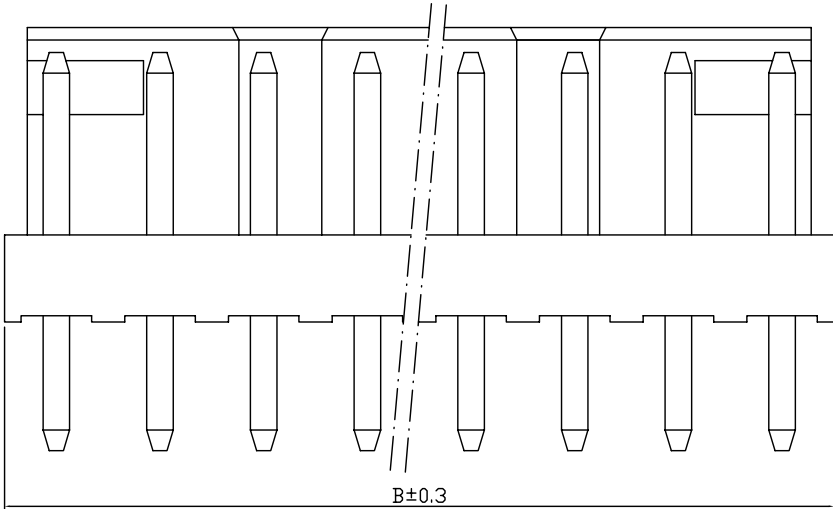

Wafer



B	5	7.5	10	12.5	15	17.5	20	22.5	25	27.5	30
A	2.5	5	7.5	10	12.5	15	17.5	20	22.5	25	27.5
Pole	2	3	4	5	6	7	8	9	10	11	12

Item		 Yueqing Hegxing Electronics Co., Ltd				
Wafer		Unit	Scale	Design Unit	Size	Part No.
LGC		mm	—	Metric	A4	 
WB25046-A		Material		Drawing No.	Part No.	
Draw	Review	Approve	Material		PA66 (UL94V-0)	

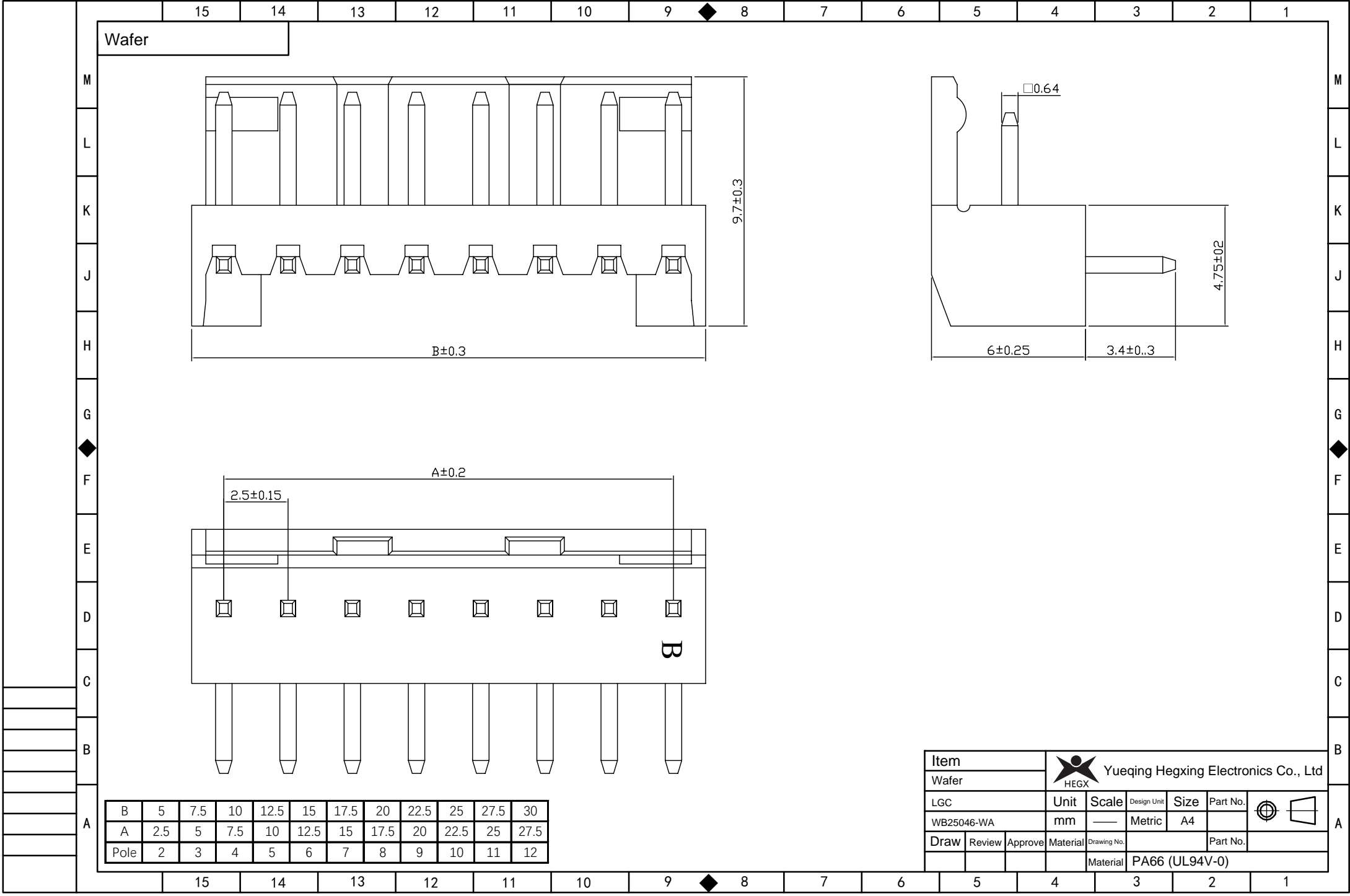

Wafer

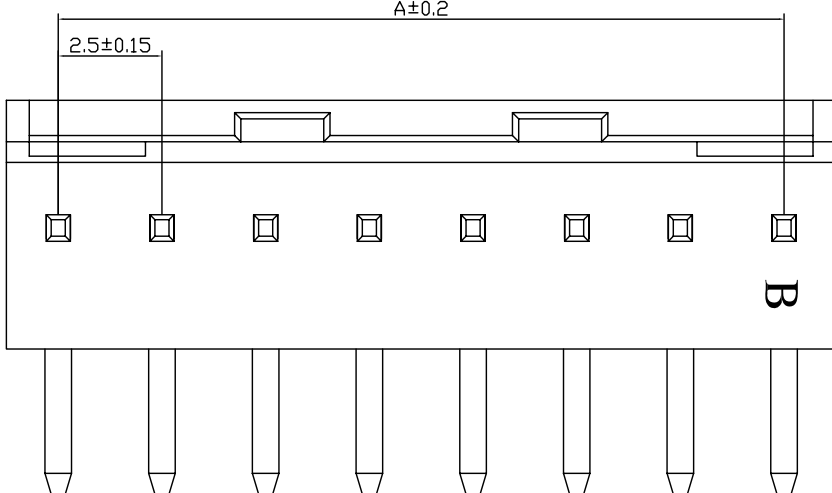
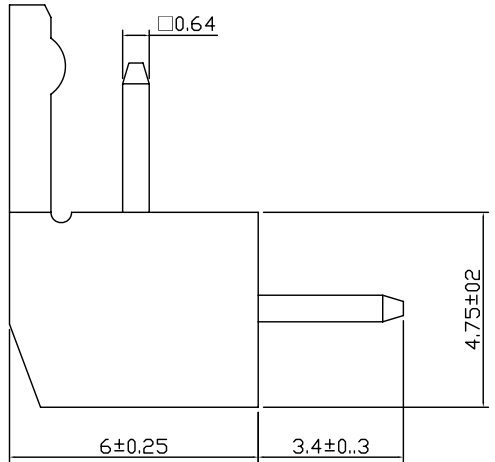
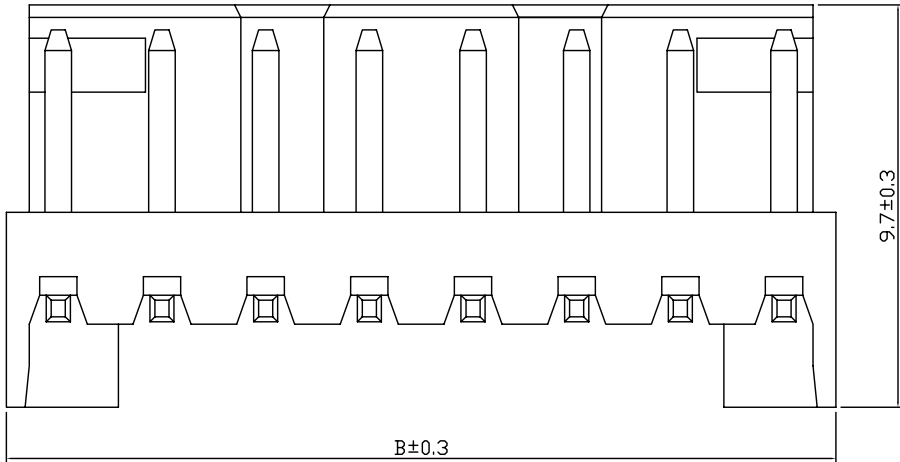

B	5	7.5	10	12.5	15	17.5	20	22.5	25	27.5	30
A	2.5	5	7.5	10	12.5	15	17.5	20	22.5	25	27.5
Pole	2	3	4	5	6	7	8	9	10	11	12

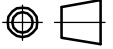
Item		 Yueqing Hegxing Electronics Co., Ltd					
Wafer		Unit	Scale	Design Unit	Size	Part No.	
LGC		mm	—	Metric	A4		
Draw	Review	Approve	Material	Drawing No.		Part No.	
			Material	PA66 (UL94V-0)			