

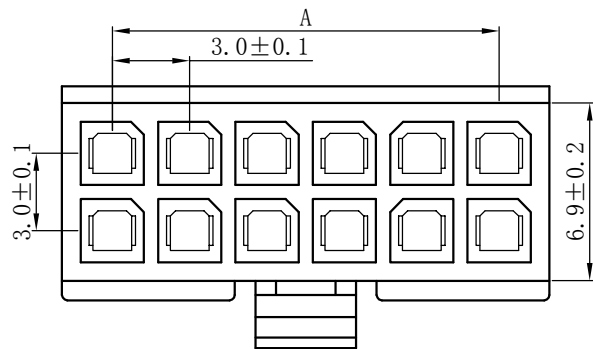

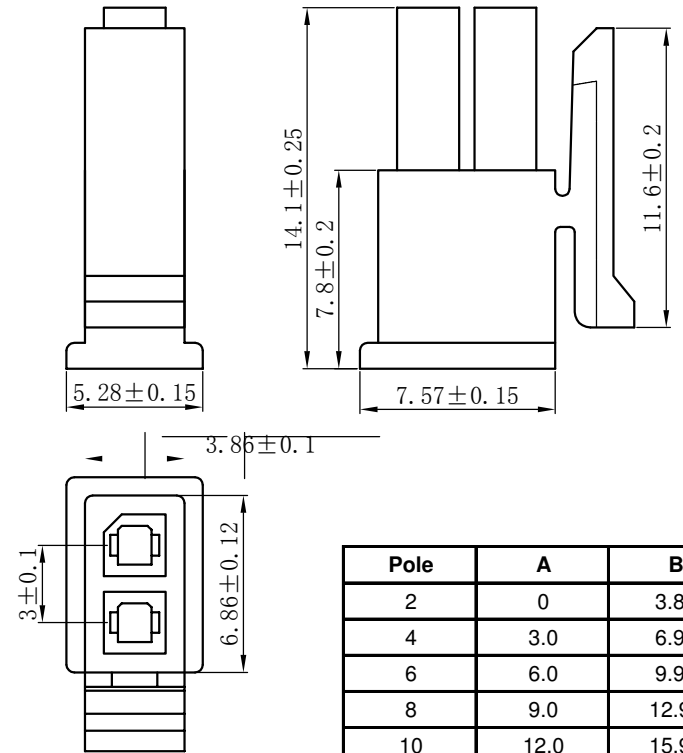

Plug Housing

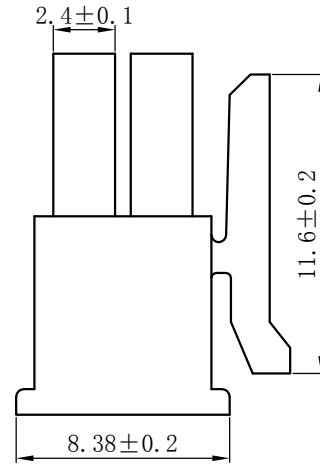
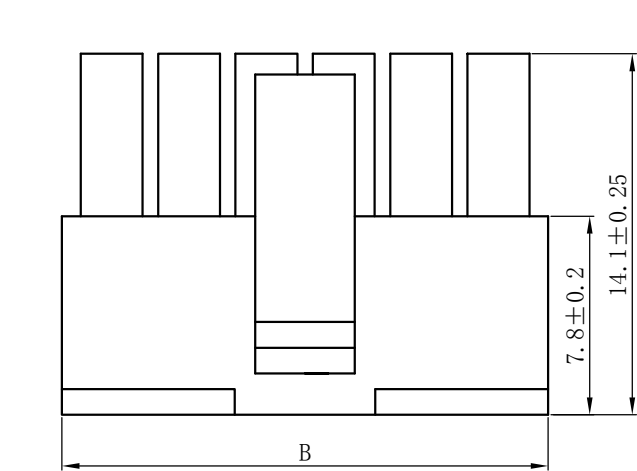

Pole	A	B
2	0	3.86
4	3.0	6.91
6	6.0	9.91
8	9.0	12.91
10	12.0	15.91
12	15.0	19.06
14	18.0	22.06
16	21.0	25.06
18	24.0	28.06
20	27.0	31.11
22	30.0	34.11
24	33.0	37.11

Item		 Yueqing Hegxing Electronics Co., Ltd					
Plug Housing		Unit	Scale	Design Unit	Size	Part No.	 
Model		mm	—	Metric	A4		
Draw	Review	Approve	Material	Drawing No.	Part No.		
			Material	PA66 (UL94V-0)			

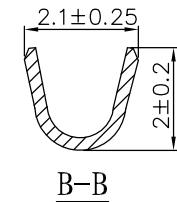
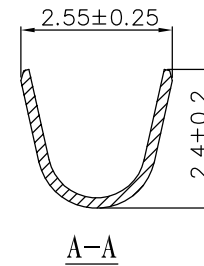
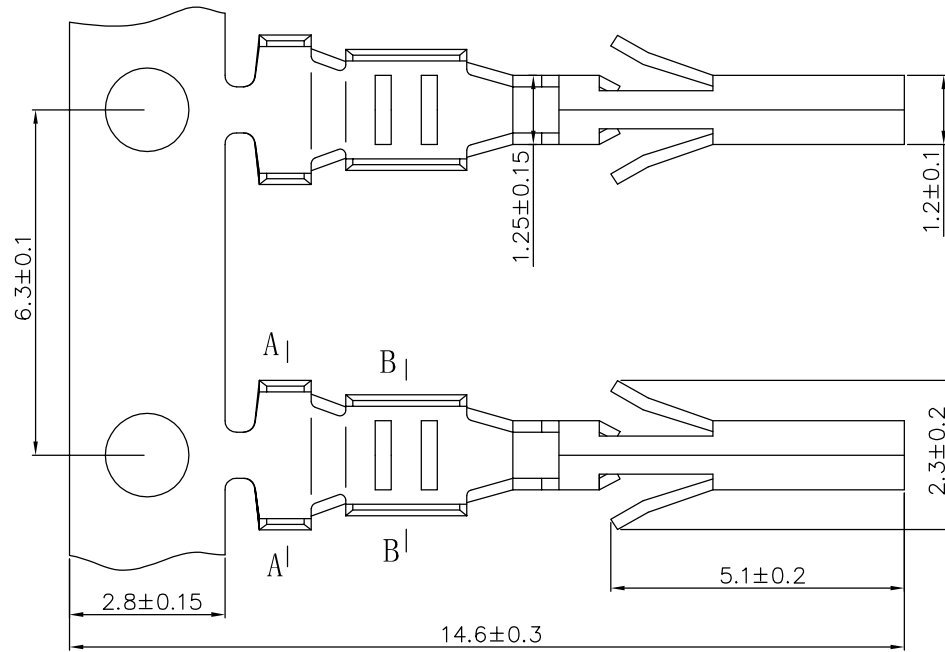
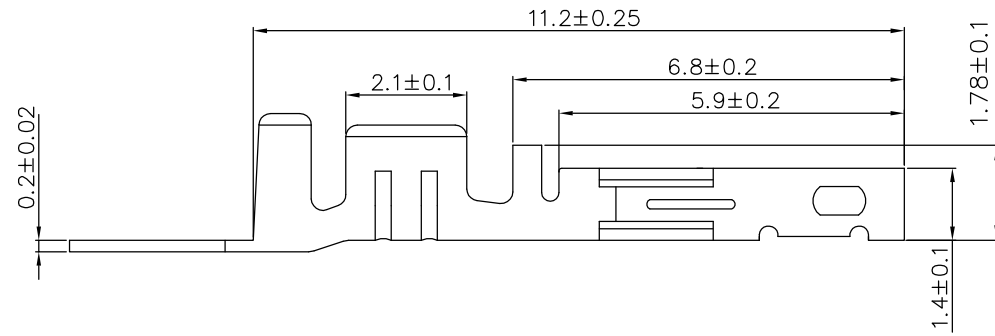

Plug Terminal

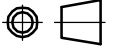

Item		 Yueqing Hegxing Electronics Co., Ltd					
Plug Terminal		Unit	Scale	Design Unit	Size	Part No.	
Model		mm	—	Metric	A4		
Draw	Review	Approve	Material	Drawing No.	Part No.		
			Material	Tinned Phosphor Bronze			

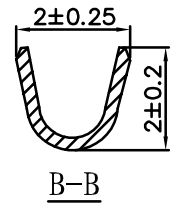
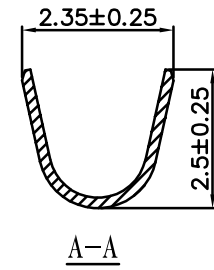
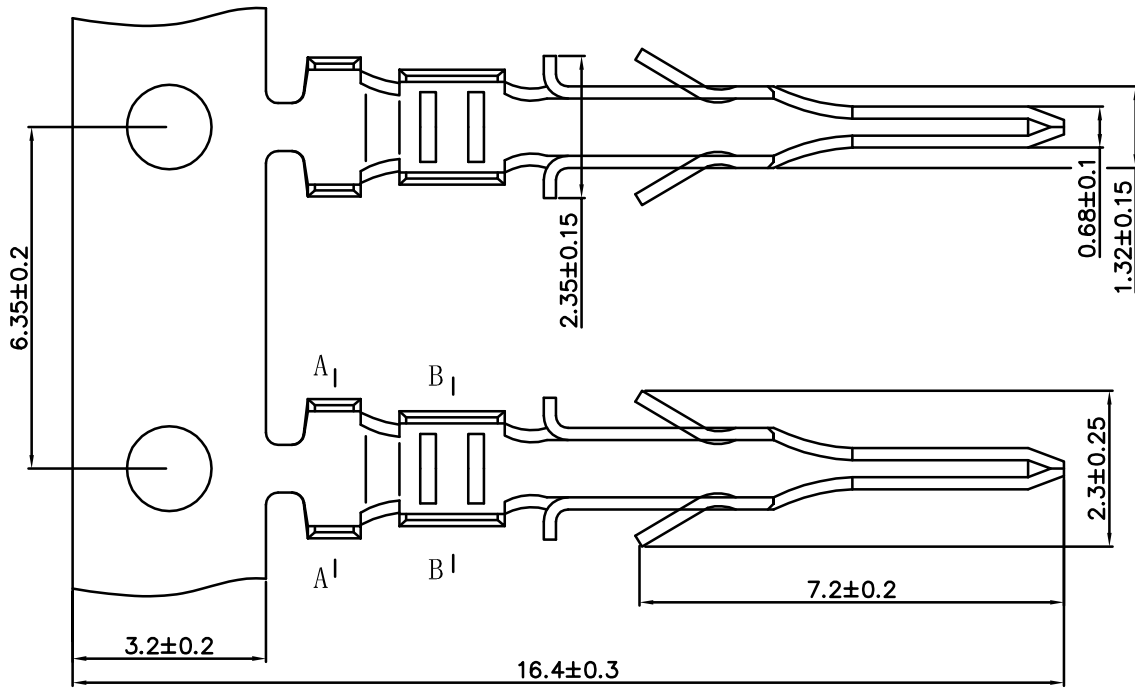
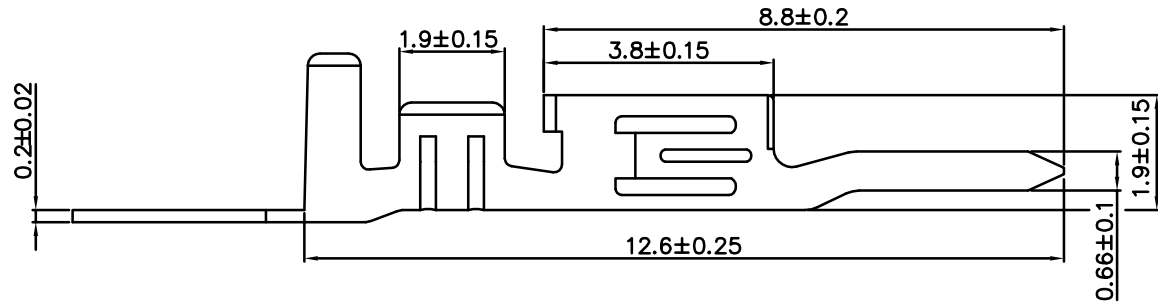
Receptacle Terminal



Item		 Yueqing Hegxing Electronics Co., Ltd					
Receptacle Terminal		Unit	Scale	Design Unit	Size	Part No.	
Model		mm	—	Metric	A4		
43031							
Draw	Review	Approve	Material	Drawing No.	Part No.		
					Material Tinned Phosphor Bronze		

Receptacle Housing

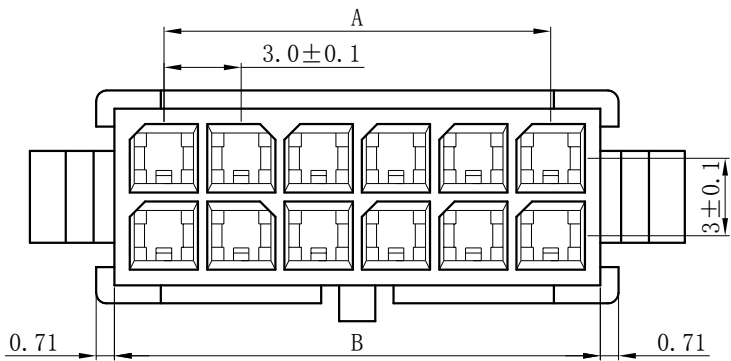
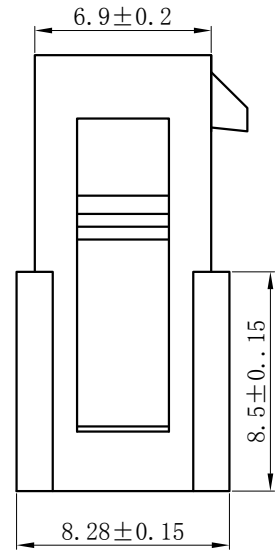
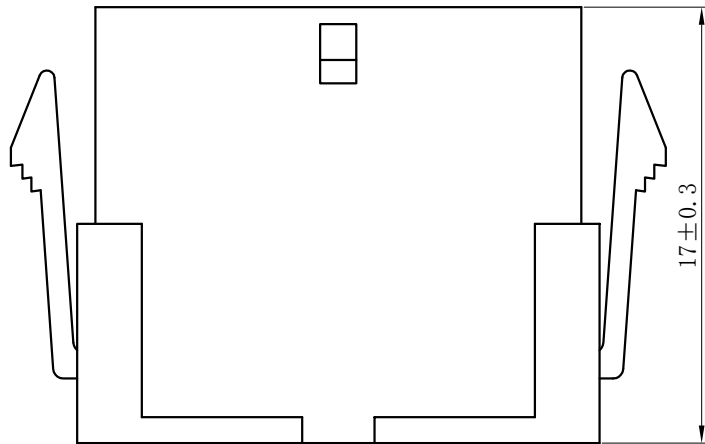

Pole	A	B
2	0	3.86
4	3.0	6.85
6	6.0	9.84
8	9.0	12.83
10	12.0	15.82
12	15.0	18.81
14	18.0	21.8
16	21.0	24.79
18	24.0	27.78
20	27.0	30.77
22	30.0	33.76
24	33.0	36.75

Item		 Yueqing Hegxing Electronics Co., Ltd				
Receptacle Housing		Unit	Scale	Design Unit	Size	Part No.
Model		mm	—	Metric	A4	
43020	Draw	Review	Approve	Material	Drawing No.	Part No.
				PA66 (UL94V-0)		