

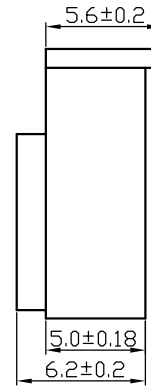

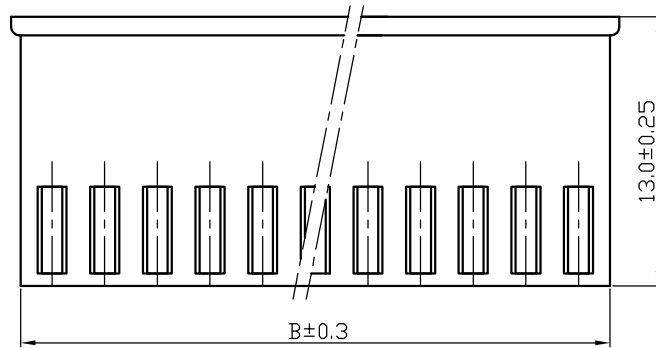

Plug Housing

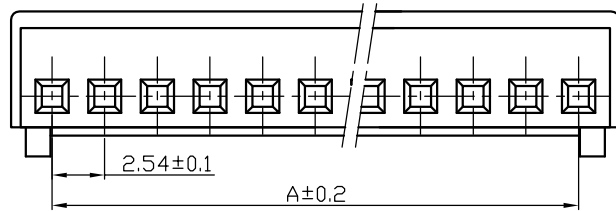



Pole	A	B
2	2.54	5.58
3	5.08	8.12
4	7.62	10.66
5	10.16	13.2
6	12.7	15.74
7	15.24	18.28
8	17.78	20.82
9	20.32	23.36
10	22.86	25.9
11	25.4	28.44
12	27.94	30.98
13	30.48	33.52
14	33.02	36.06
15	35.56	38.6

Item		 Yueqing Hegxing Electronics Co., Ltd					
Plug Housing		Unit	Scale	Design Unit	Size	Part No.	 
Model		mm	—	Metric	A4		
CH10	Draw	Review	Approve	Material	Drawing No.	Part No.	
				Material	PA66 (UL94V-0)		

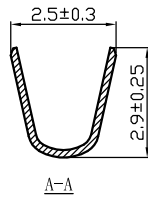
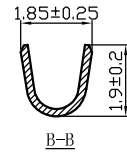
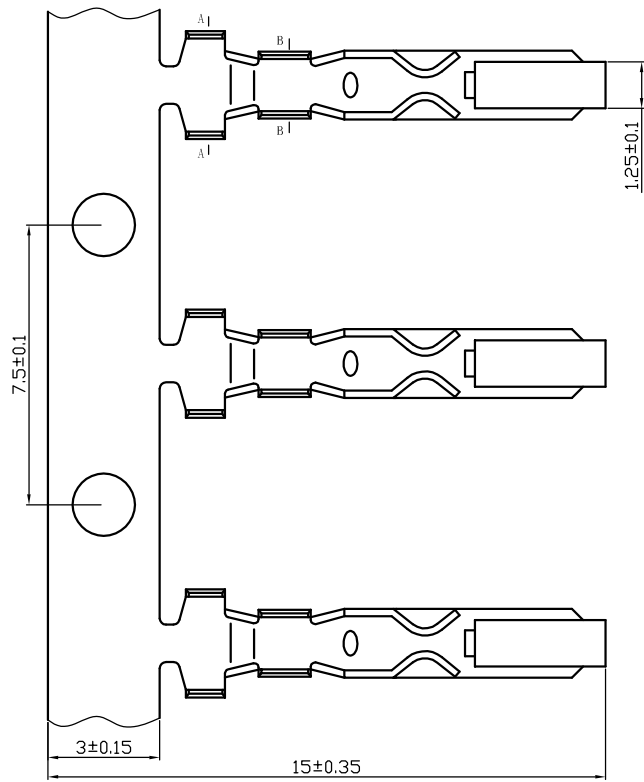
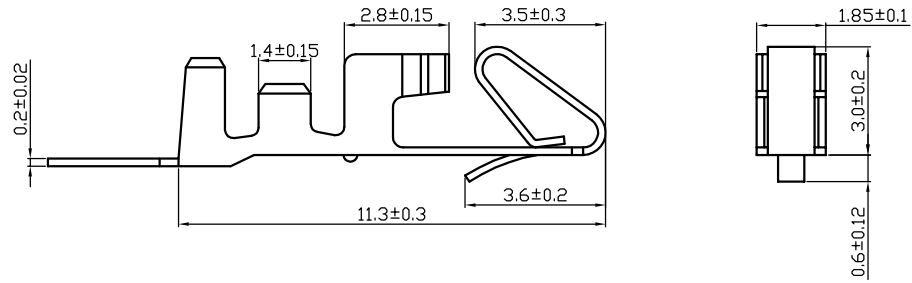
Plug Terminal



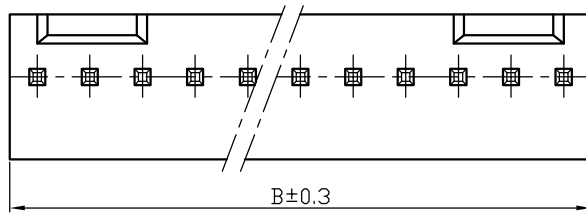
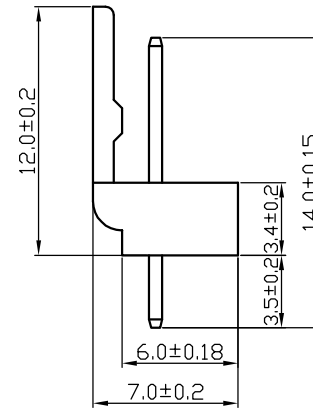
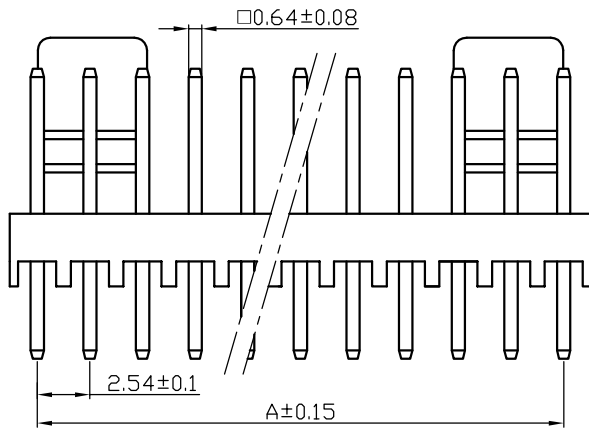

Item		 Yueqing Hegxing Electronics Co., Ltd				
Plug Terminal		Unit	Scale	Design Unit	Size	Part No.
Model		mm	—	Metric	A4	 
CH10						
Draw	Review	Approve	Material	Drawing No.	Part No.	
			Material	Tinned Phosphor Bronze		

Wafer



Pole	A	B
2	2.54	5.18
3	5.08	7.72
4	7.62	10.26
5	10.16	12.8
6	12.7	15.34
7	15.24	17.88
8	17.78	20.42
9	20.32	22.96
10	22.86	25.5
11	25.4	28.04
12	27.94	30.58
13	30.48	33.12
14	33.02	35.66
15	35.56	38.2

Item		 Yueqing Hegxing Electronics Co., Ltd				
Wafer		Unit	Scale	Design Unit	Size	Part No.
5045		mm	—	Metric	A4	 
Draw	Review	Approve	Material	Drawing No.	Part No.	
			Material	PA66 (UL94V-0)		

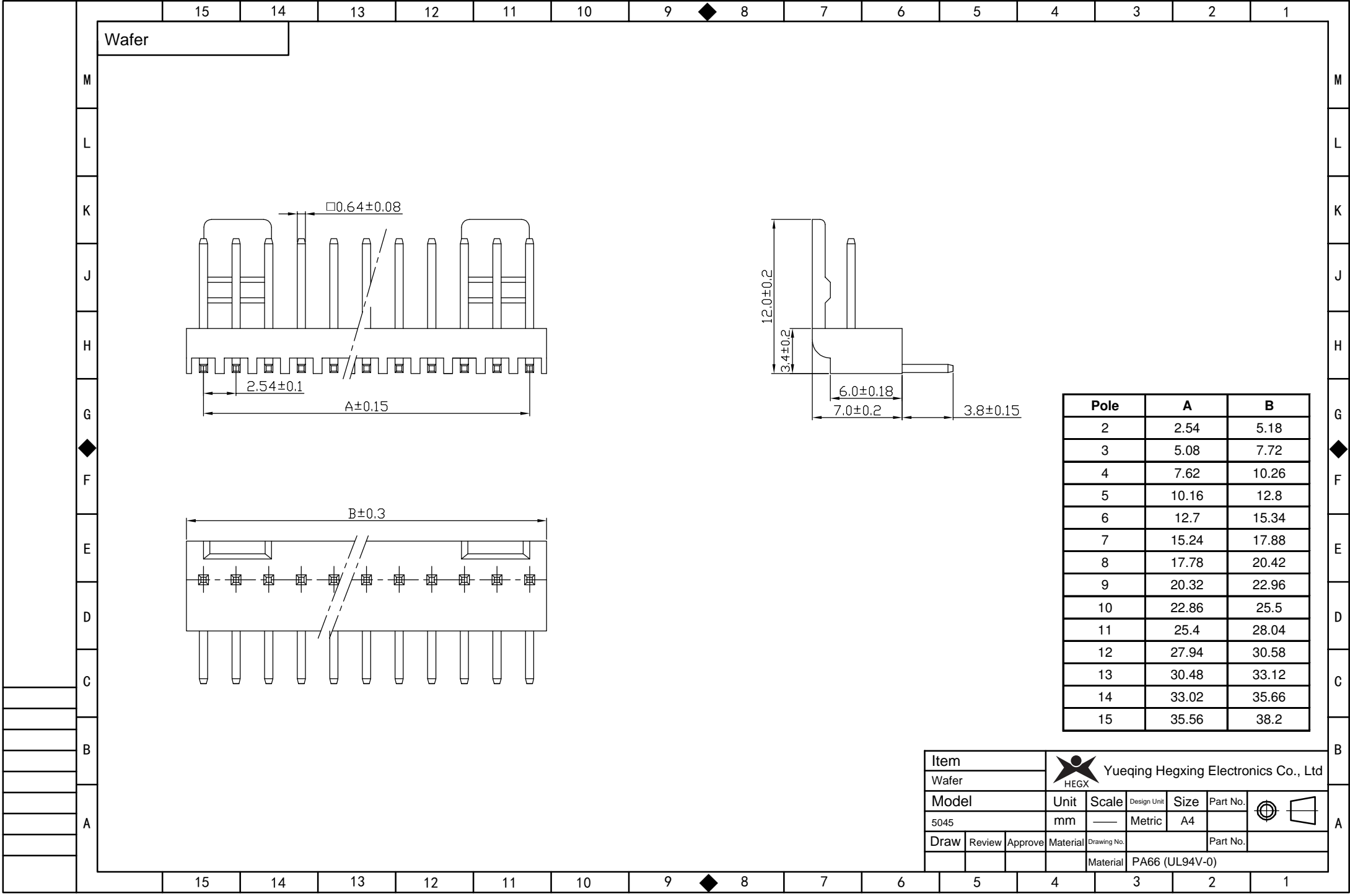

Wafer

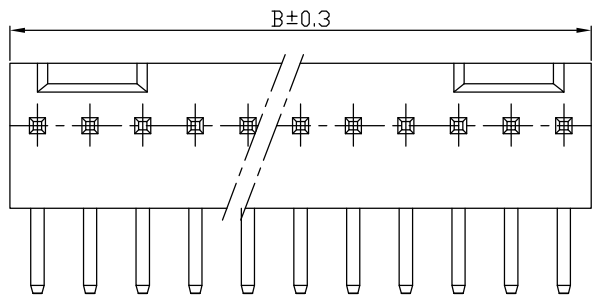
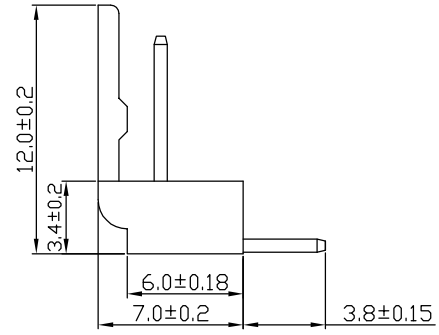
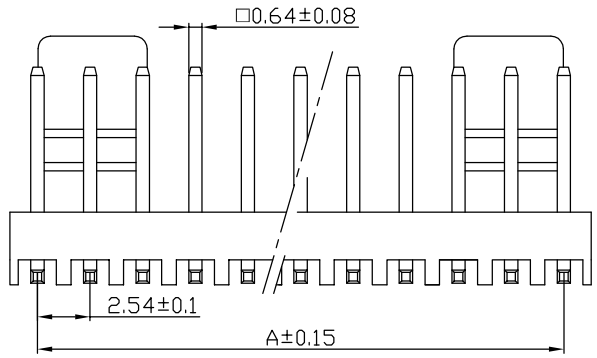

Pole	A	B
2	2.54	5.18
3	5.08	7.72
4	7.62	10.26
5	10.16	12.8
6	12.7	15.34
7	15.24	17.88
8	17.78	20.42
9	20.32	22.96
10	22.86	25.5
11	25.4	28.04
12	27.94	30.58
13	30.48	33.12
14	33.02	35.66
15	35.56	38.2

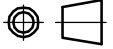
Item		 Yueqing Hegxing Electronics Co., Ltd				
Wafer		Unit	Scale	Design Unit	Size	Part No.
5045		mm	—	Metric	A4	
Draw	Review	Approve	Material	Drawing No.	Part No.	
			Material	PA66 (UL94V-0)		