

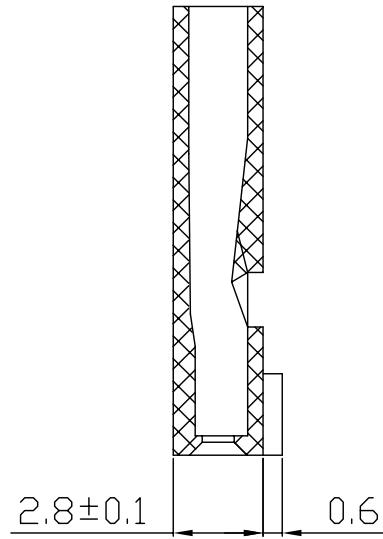

Plug Housing

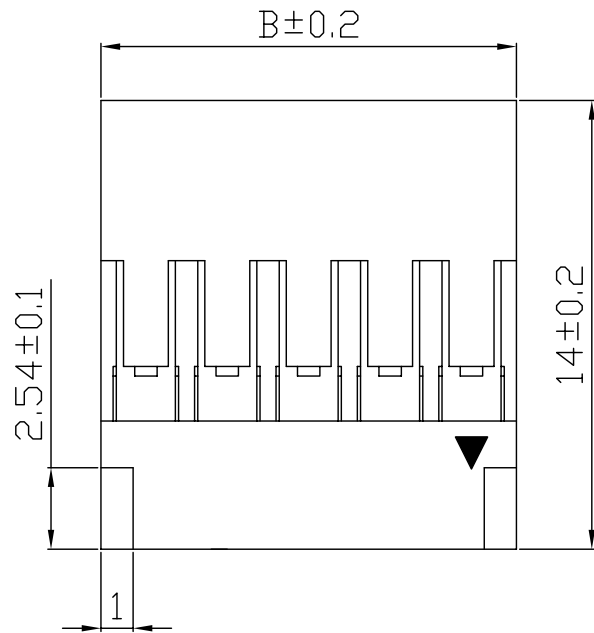

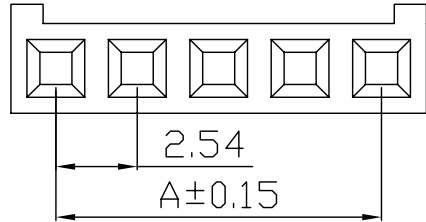

Pole	A	B
2	2.54	5.34
3	5.08	7.88
4	7.62	10.42
5	10.16	12.96
6	12.7	15.5
7	15.24	18.04
8	17.78	20.58
9	20.32	23.12
10	22.86	25.66
11	25.4	28.2
12	27.94	30.74

Item		 Yueqing Hegxing Electronics Co., Ltd				
Plug Housing		Unit	Scale	Design Unit	Size	Part No.
Model		mm	—	Metric	A4	
Draw	Review	Approve	Material	Drawing No.	Part No.	
			Material	PA66 (UL94V-0)		

Grid labels: 15, 14, 13, 12, 11, 10, 9, 8, 7, 6, 5, 4, 3, 2, 1 (horizontal); M, L, K, J, H, G, F, E, D, C, B, A (vertical)

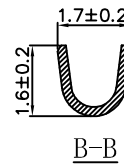
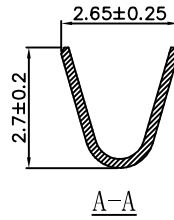
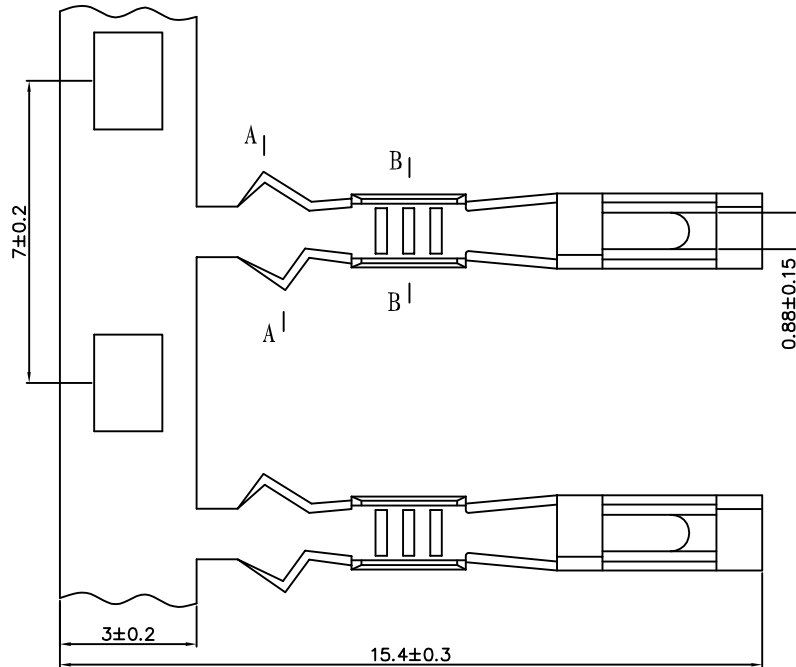
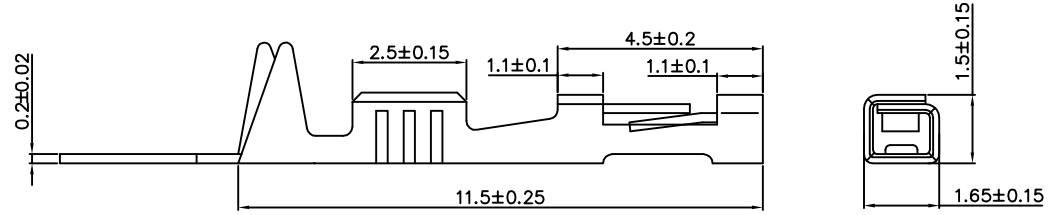
Receptacle Terminal

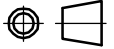

Item		 Yueqing Hegxing Electronics Co., Ltd					
Receptacle Terminal		Unit	Scale	Design Unit	Size	Part No.	
Model		mm	—	Metric	A4		
Draw	Review	Approve	Material	Drawing No.		Part No.	
			Material	Tinned Phosphor Bronze			

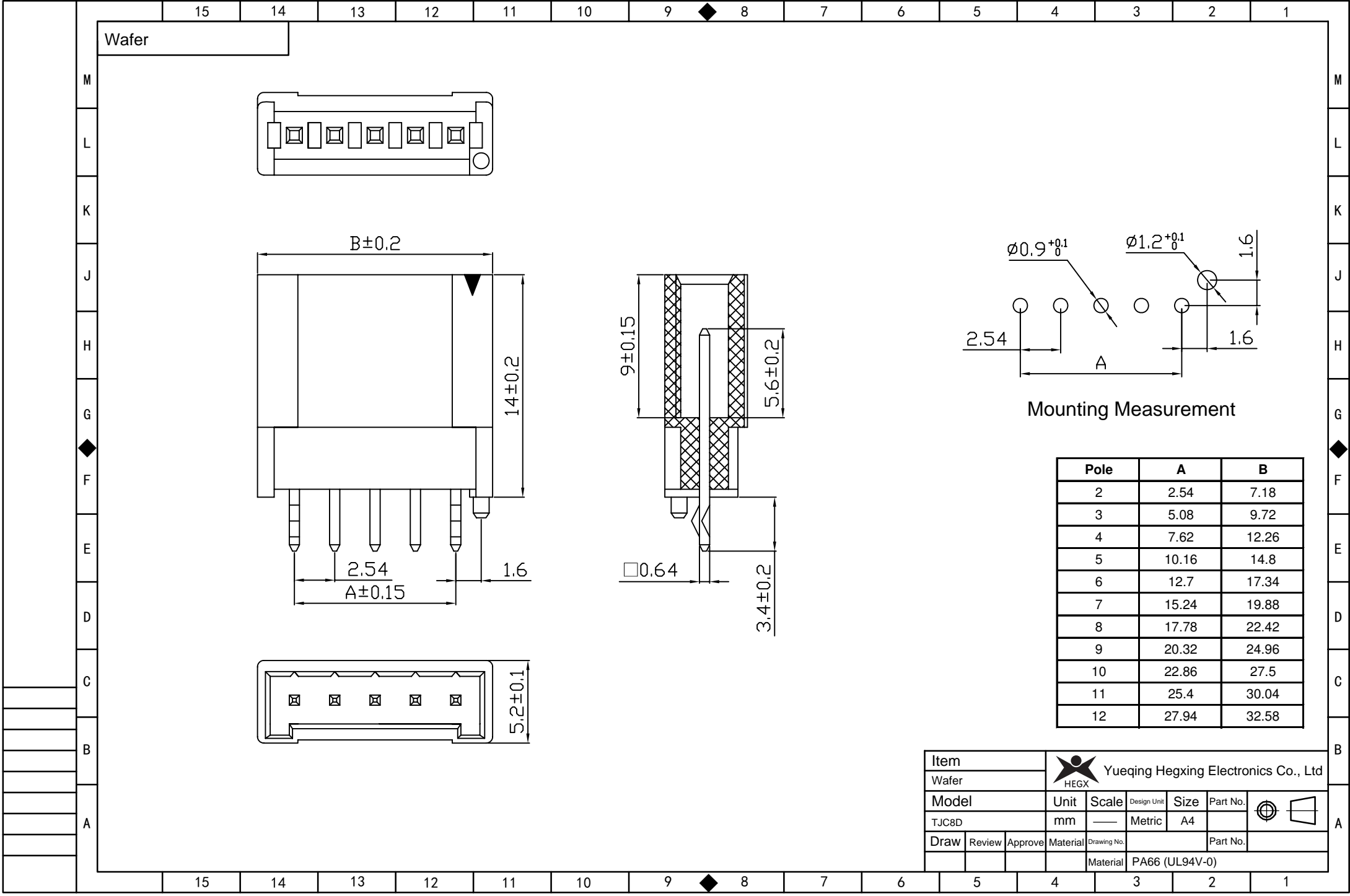

Mounting Measurement

Pole	A	B
2	2.54	7.18
3	5.08	9.72
4	7.62	12.26
5	10.16	14.8
6	12.7	17.34
7	15.24	19.88
8	17.78	22.42
9	20.32	24.96
10	22.86	27.5
11	25.4	30.04
12	27.94	32.58

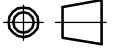
Item		 Yueqing Hegxing Electronics Co., Ltd				
Wafer		Unit	Scale	Design Unit	Size	Part No.
TJC8D		mm	—	Metric	A4	
Draw	Review	Approve	Material	Drawing No.	Part No.	
			Material	PA66 (UL94V-0)		