

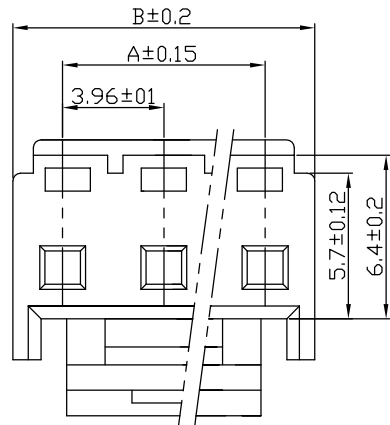

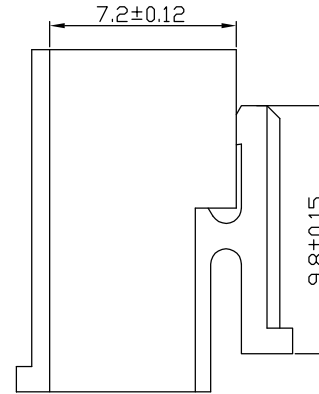

Plug Housing

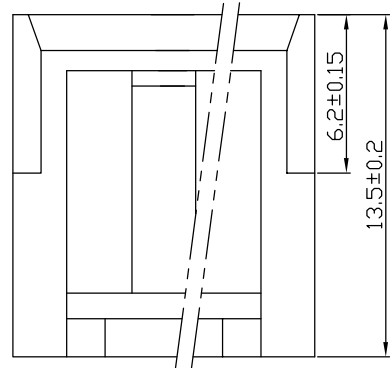

Pole	A	B
2	3.96	7.92
3	7.92	11.88
4	11.88	15.78
5	15.84	19.71
6	19.8	23.7
7	23.76	27.66
8	27.72	31.62
9	31.68	35.58
10	35.64	39.54
11	39.6	43.5
12	43.56	47.46

Item		 Yueqing Hegxing Electronics Co., Ltd				
Plug Housing						
Model	Unit	Scale	Design Unit	Size	Part No.	 
VHR	mm	—	Metric	A4		
Draw	Review	Approve	Material	Drawing No.	Part No.	
			Material	PA66 (UL94V-0)		

Plug Terminal

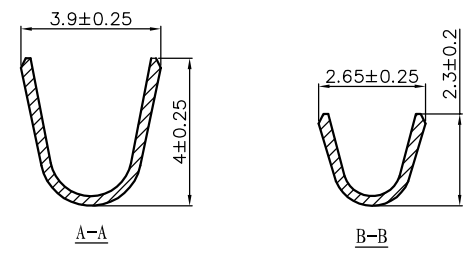
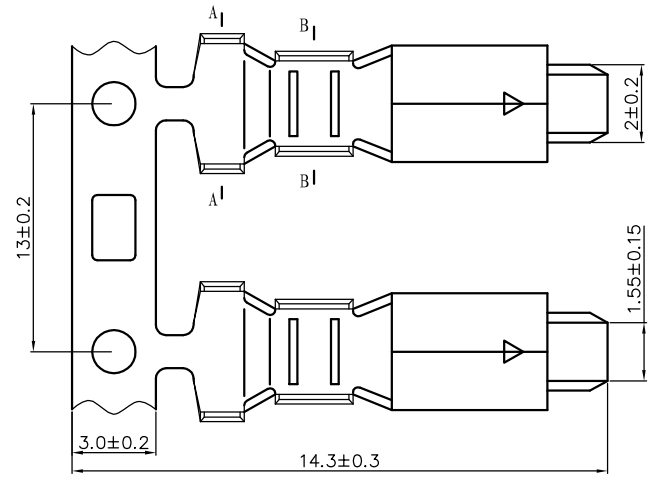
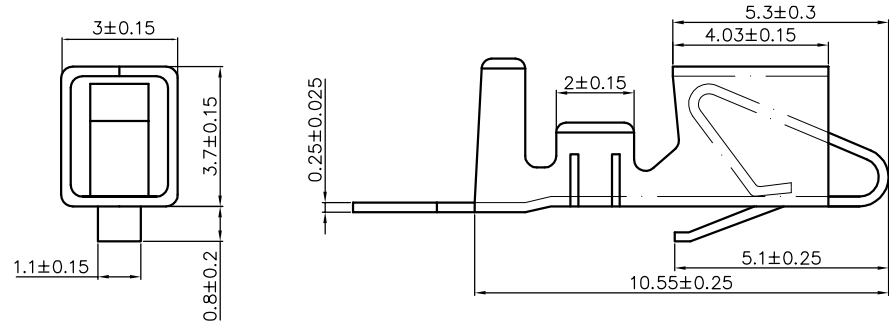

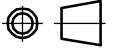
Item		 Yueqing Hegxing Electronics Co., Ltd				
Receptacle Terminal		Unit	Scale	Design Unit	Size	Part No.
VHR-PT		mm	—	Metric	A4	
Draw	Review	Approve	Material	Drawing No.	Part No.	
			Material	Tinned Phosphor Bronze		

Receptacle Housing

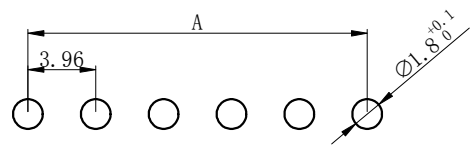
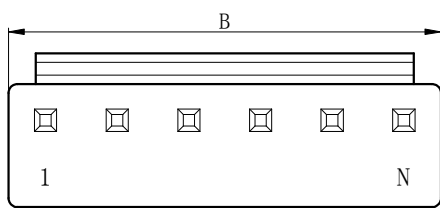
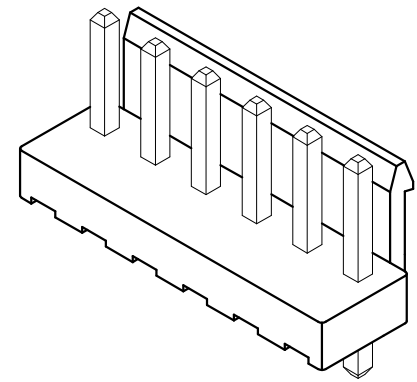
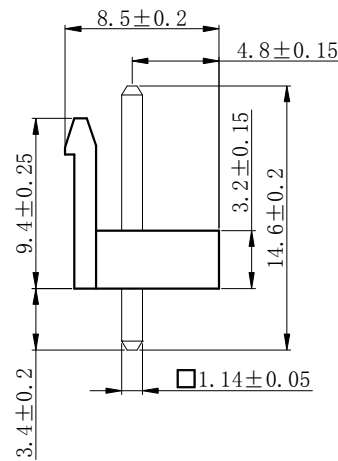
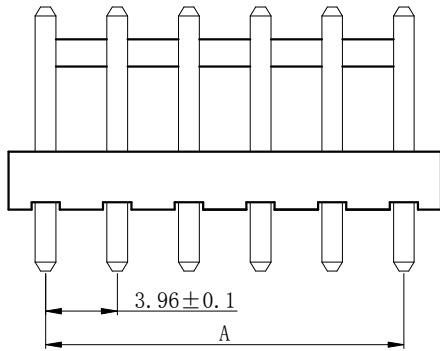

P. C. B Board Layout (t=1.6mm)

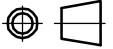

Pole	A	B
2	3.96	7.92
3	7.92	11.88
4	11.88	15.84
5	15.84	19.8
6	19.8	23.76
7	23.76	27.72
8	27.72	31.68
9	31.68	35.64
10	35.64	39.6
11	39.6	43.56
12	43.56	47.52
13	47.52	51.48
14	51.48	55.44
15	55.44	59.4

Item		 Yueqing Hegxing Electronics Co., Ltd					
Receptacle Housing		Unit	Scale	Design Unit	Size	Part No.	
Model		mm	—	Metric	A4		
Draw	Review	Approve	Material	Drawing No.	Part No.		
			Material	PA66 (UL94V-0)			

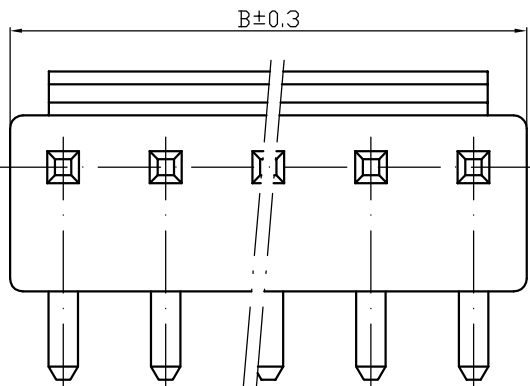
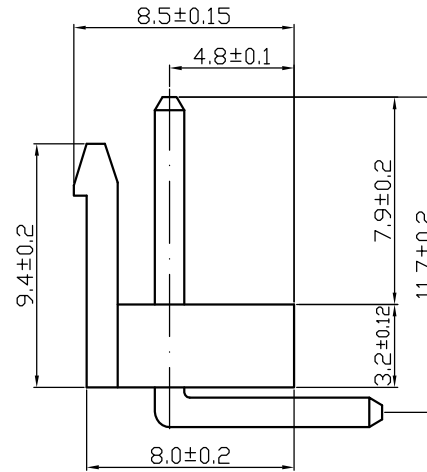
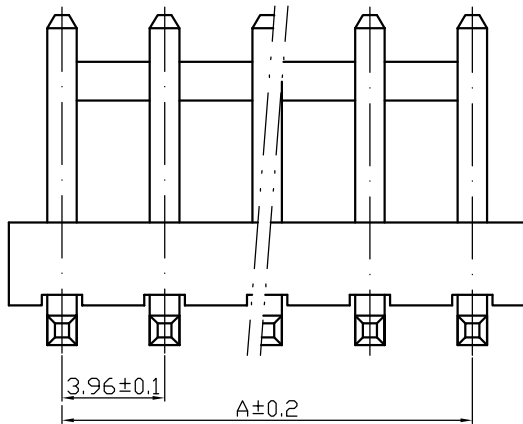
Wafer



Pole	A	B
2	3.96	7.92
3	7.92	11.88
4	11.88	15.84
5	15.84	19.8
6	19.8	23.76
7	23.76	27.72
8	27.72	31.68
9	31.68	35.64
10	35.64	39.6
11	39.6	43.56
12	43.56	47.52
13	47.52	51.48
14	51.48	55.44
15	55.44	59.4

Item		 Yueqing Hegxing Electronics Co., Ltd				
Wafer		Unit	Scale	Design Unit	Size	Part No.
VHR-WAP		mm	—	Metric	A4	 
Draw	Review	Approve	Material	Drawing No.	Part No.	
			Material	PA66 (UL94V-0)		

Wafer

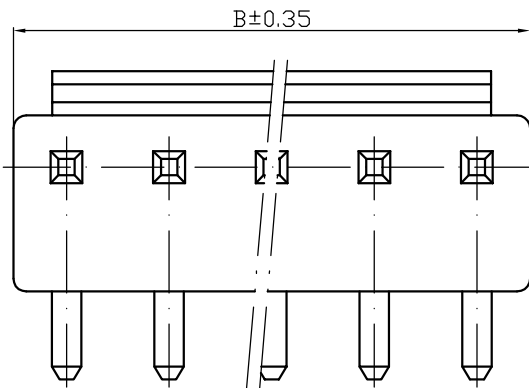
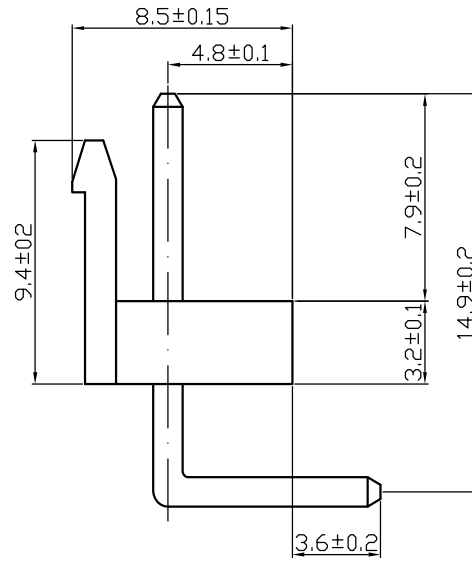
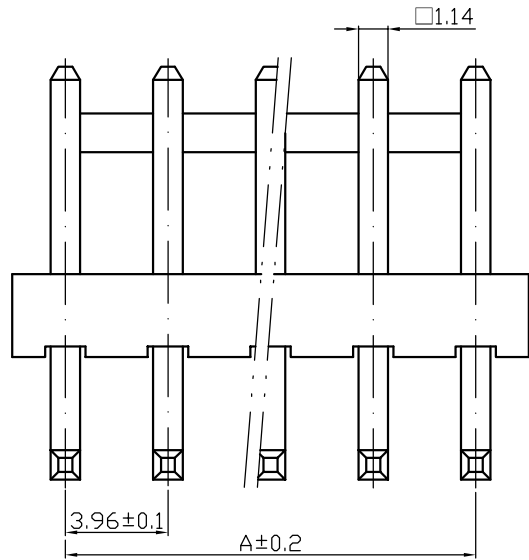

Pole	A	B
2	3.96	7.92
3	7.92	11.88
4	11.88	15.84
5	15.84	19.8
6	19.8	23.76
7	23.76	27.72
8	27.72	31.68
9	31.68	35.64
10	35.64	39.6
11	39.6	43.56
12	43.56	47.52
13	47.52	51.48
14	51.48	55.44
15	55.44	59.4

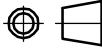
Item		 Yueqing Hegxing Electronics Co., Ltd				
Wafer		Unit	Scale	Design Unit	Size	Part No.
VHR-WAG		mm	—	Metric	A4	
Draw	Review	Approve	Material	Drawing No.	Part No.	
			Material	PA66 (UL94V-0)		