

15 14 13 12 11 10 9 8 7 6 5 4 3 2 1

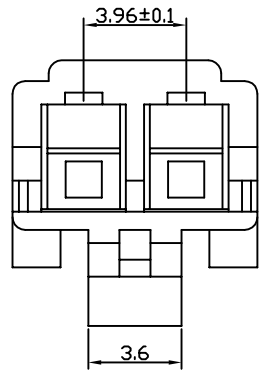
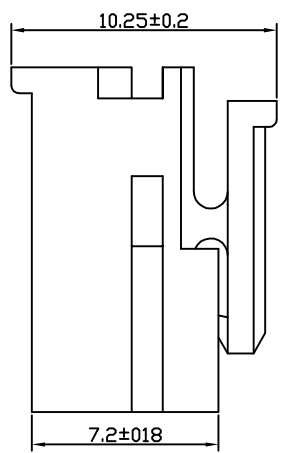
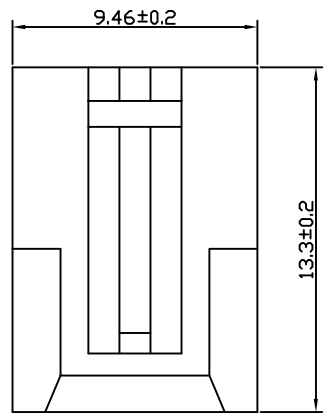

Plug Housing

M
L
K
J
H
G
F
E
D
C
B
A

M
L
K
J
H
G
F
E
D
C
B
A



2P

Item		 Yueqing Hegxing Electronics Co., Ltd						
Plug Housing		Unit	Scale	Design Unit	Size	Part No.	 	
Model		mm	—	Metric	A4			
VHRR / 39616								
Draw	Review	Approve	Material	Drawing No.	Part No.			
			Material	PA66 (UL94V-0)				

15 14 13 12 11 10 9 8 7 6 5 4 3 2 1

15 14 13 12 11 10 9 8 7 6 5 4 3 2 1



Plug Housing

M
L
K
J
H
G
F
E
D
C
B
A

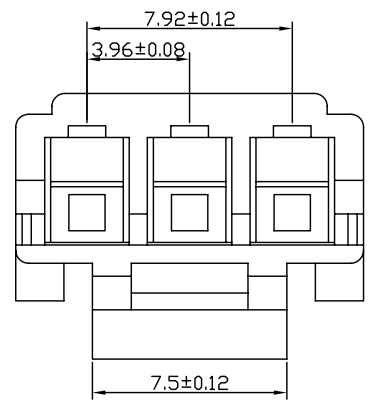
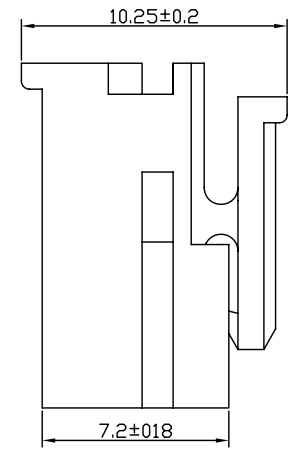
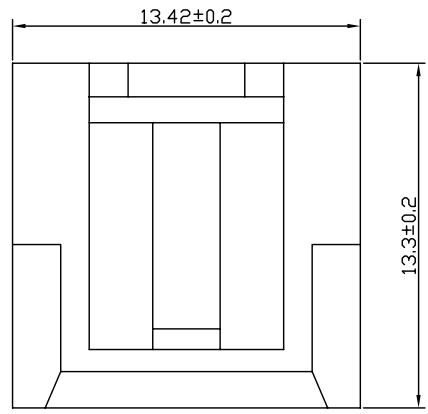
M
L
K
J
H
G
F
E
D
C
B
A



3P



Item		 Yueqing Hegxing Electronics Co., Ltd						
Plug Housing		Unit	Scale	Design Unit	Size	Part No.	 	
Model		mm	—	Metric	A4			
Draw	Review	Approve	Material	Drawing No.	Part No.			
			Material	PA66 (UL94V-0)				

15 14 13 12 11 10 9 8 7 6 5 4 3 2 1

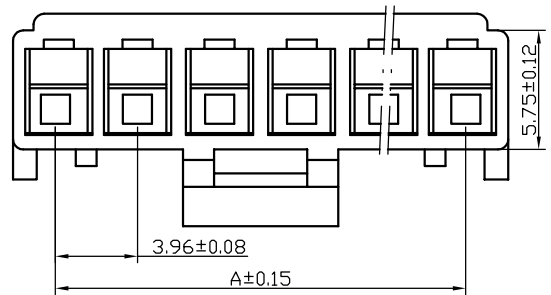
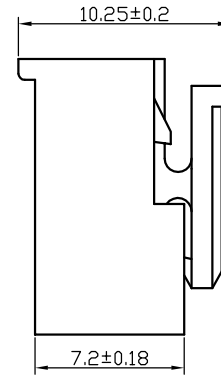
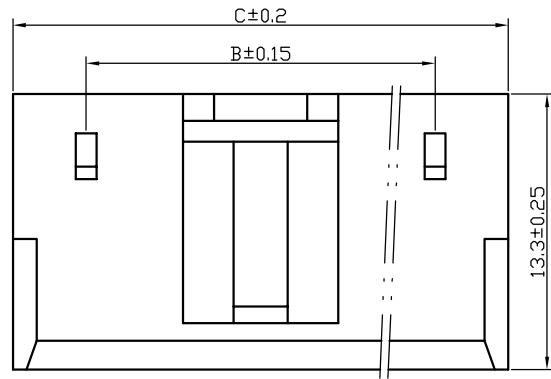
Plug Housing



Pole	A	B	C
4	11.88	8.92	15.98
5	15.84	12.88	19.94
6	19.8	16.84	23.9
7	23.76	20.8	27.86
8	27.72	24.76	31.82
9	31.68	28.72	35.78
10	35.64	32.68	39.74
11	39.6	36.64	43.7
12	43.56	40.6	47.66
13	47.52	44.56	51.62
14	51.48	48.52	55.58
15	55.44	52.48	59.54

Item		 Yueqing Hegxing Electronics Co., Ltd				
Plug Housing		Unit	Scale	Design Unit	Size	Part No.
VHRR / 39616		mm	—	Metric	A4	
Draw	Review	Approve	Material	Drawing No.	Part No.	
			Material	PA66 (UL94V-0)		

Plug Terminal

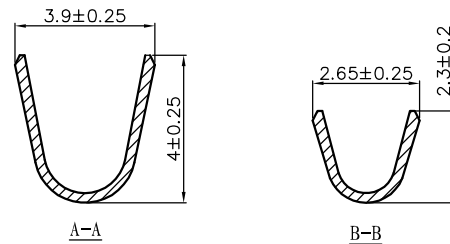
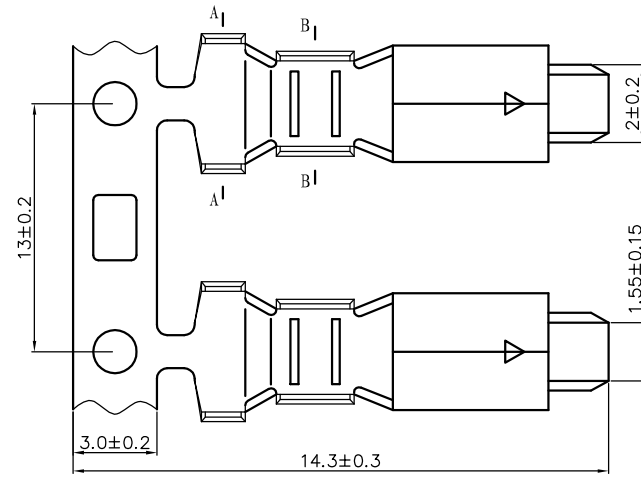
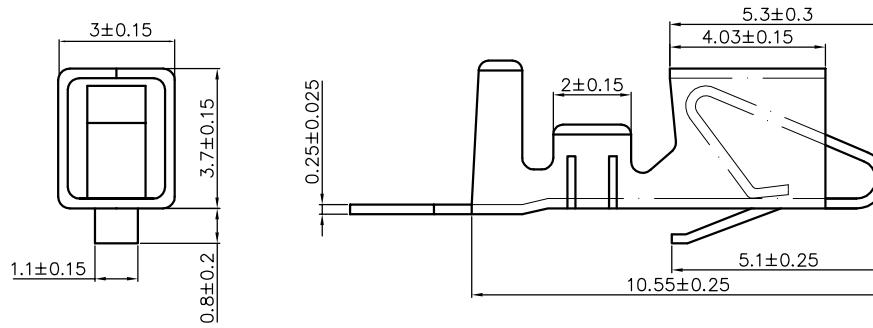

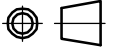
Item		 Yueqing Hegxing Electronics Co., Ltd				
Plug Terminal		Unit	Scale	Design Unit	Size	Part No.
Model		mm	—	Metric	A4	
VHRR / 39616 - PT		Draw	Review	Approve	Material	Part No.
					Material	Tinned Phosphor Bronze

Receptacle Terminal

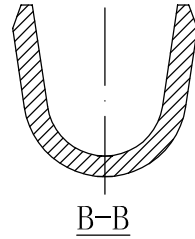
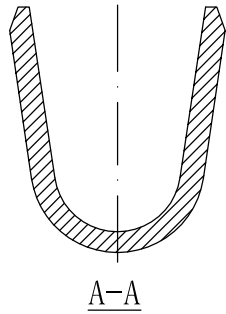
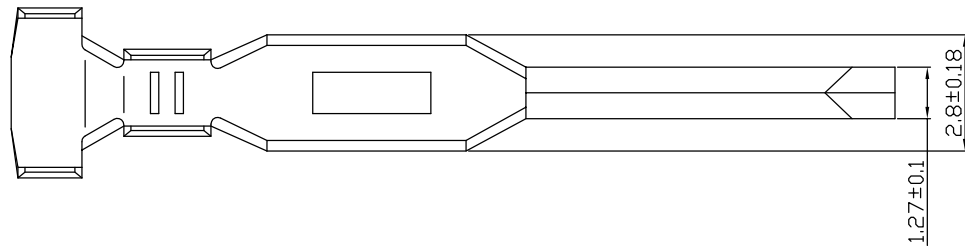
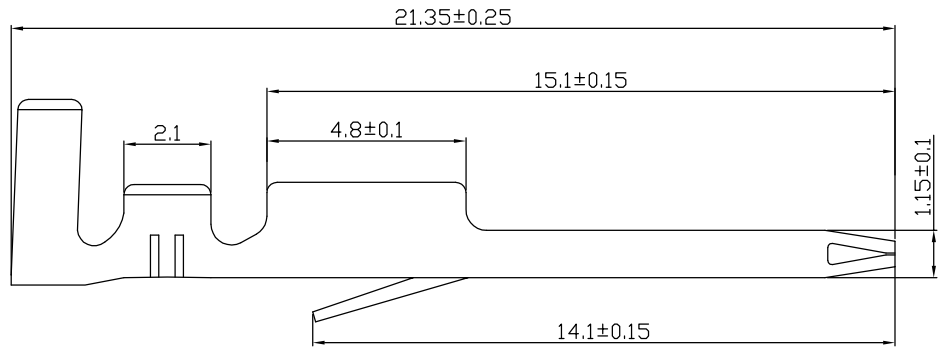

Item		 Yueqing Hegxing Electronics Co., Ltd				
Receptacle Terminal		Unit	Scale	Design Unit	Size	Part No.
Model		mm	—	Metric	A4	
Draw	Review	Approve	Material	Drawing No.	Part No.	
			Material	Tinned Phosphor Bronze		

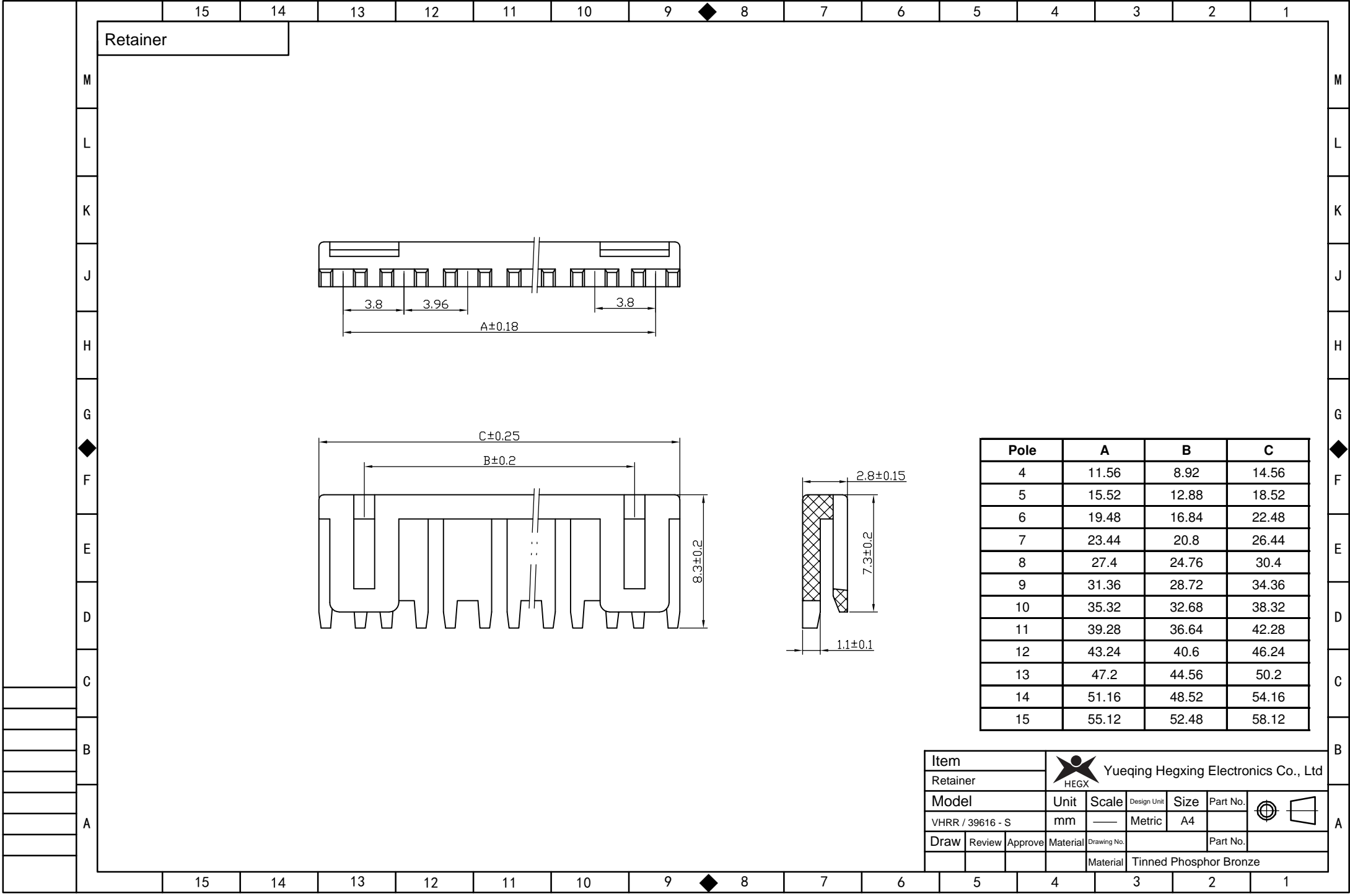



Pole	A	B	C
4	11.56	8.92	14.56
5	15.52	12.88	18.52
6	19.48	16.84	22.48
7	23.44	20.8	26.44
8	27.4	24.76	30.4
9	31.36	28.72	34.36
10	35.32	32.68	38.32
11	39.28	36.64	42.28
12	43.24	40.6	46.24
13	47.2	44.56	50.2
14	51.16	48.52	54.16
15	55.12	52.48	58.12

Item		 Yueqing Hegxing Electronics Co., Ltd				
Retainer		Unit	Scale	Design Unit	Size	Part No.
VHRR / 39616 - S		mm	—	Metric	A4	
Draw	Review	Approve	Material	Drawing No.	Part No.	
			Material	Tinned Phosphor Bronze		

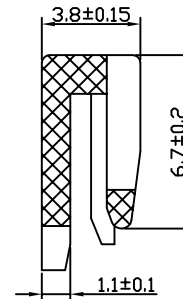
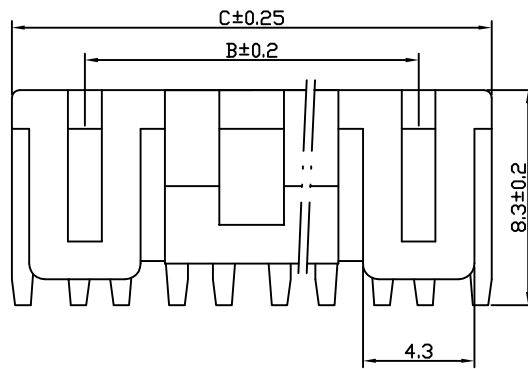
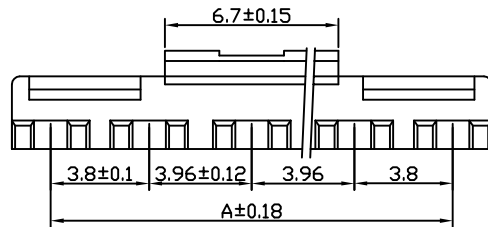
Retainer



Pole	A	B	C
4	11.56	8.92	14.56
5	15.52	12.88	18.52
6	19.48	16.84	22.48
7	23.44	20.8	26.44
8	27.4	24.76	30.4
9	31.36	28.72	34.36
10	35.32	32.68	38.32
11	39.28	36.64	42.28
12	43.24	40.6	46.24
13	47.2	44.56	50.2
14	51.16	48.52	54.16
15	55.12	52.48	58.12

Item		 Yueqing Hegxing Electronics Co., Ltd				
Retainer		Unit	Scale	Design Unit	Size	Part No.
Model		mm	—	Metric	A4	 
VHRR / 39616 - HS						
Draw	Review	Approve	Material	Drawing No.	Part No.	
			Material	Tinned Phosphor Bronze		

Receptacle Housing

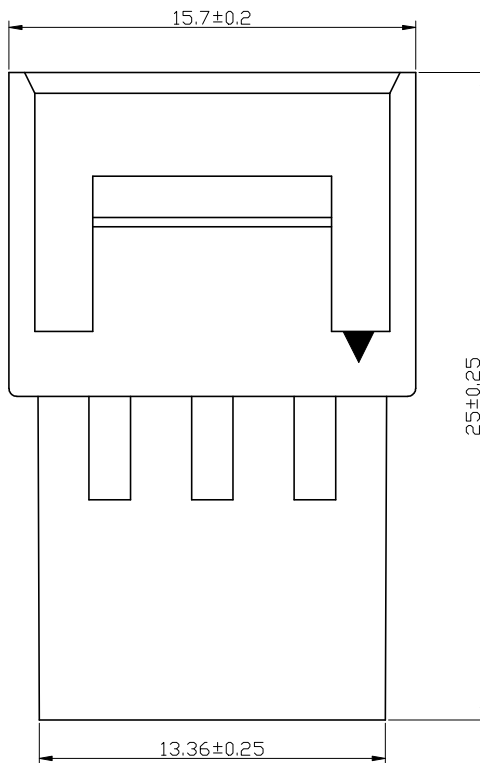
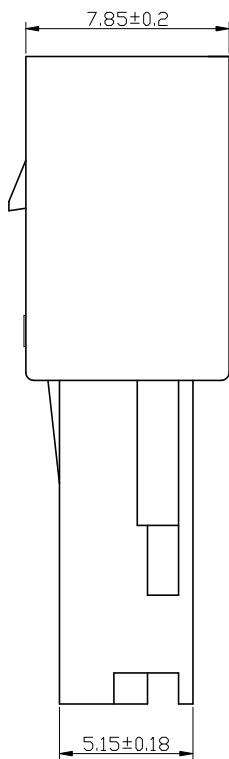
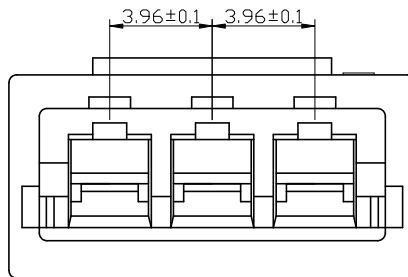



3P

Item		 Yueqing Hegxing Electronics Co., Ltd				
Receptacle Housing		Unit	Scale	Design Unit	Size	Part No.
Model		mm	—	Metric	A4	
VHRR / 39616 - R						
Draw	Review	Approve	Material	Drawing No.	Part No.	
			Material	PA66 (UL94V-0)		

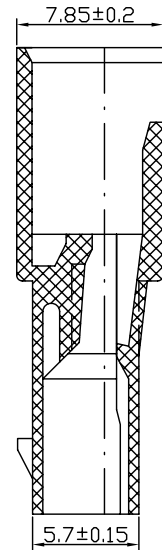
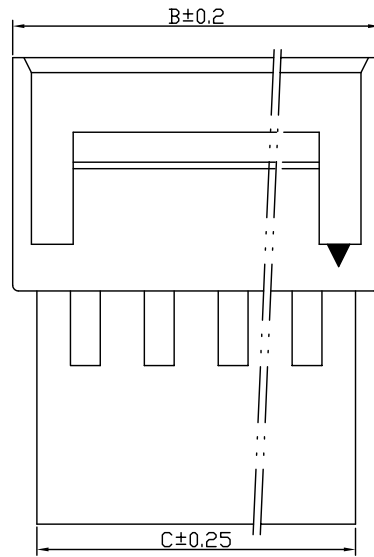
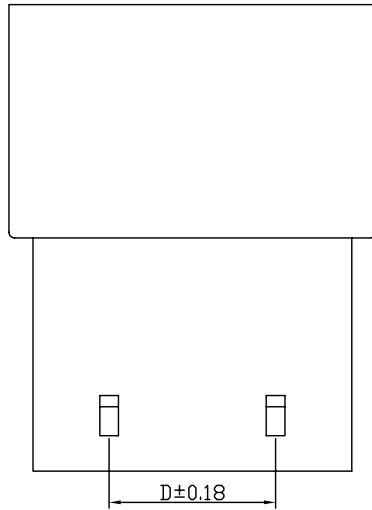
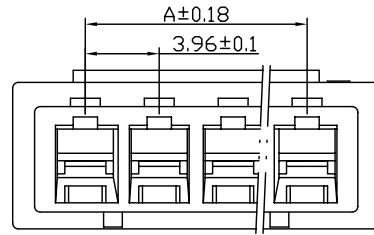
Receptacle Housing



Pole	A	B	C	D
3	7.92	15.7	13.12	4.96
4	11.88	19.66	17.08	8.92
5	15.84	23.62	21.04	12.88
6	19.8	27.58	25	16.84
7	23.76	31.54	28.96	20.8
8	27.72	35.5	32.92	24.76
9	31.68	39.46	36.88	28.72
10	35.64	43.42	40.84	32.68
11	39.6	47.38	44.8	36.64
12	43.56	51.34	48.76	40.6
13	47.52	55.3	52.72	44.56
14	51.48	59.26	56.68	48.52
15	55.44	63.22	60.64	52.48

Item		 Yueqing Hegxing Electronics Co., Ltd				
Receptacle Housing		Unit	Scale	Design Unit	Size	Part No.
Model		mm	—	Metric	A4	 
VHRR / 39616 - R						
Draw	Review	Approve	Material	Drawing No.	Part No.	
			Material	PA66 (UL94V-0)		