

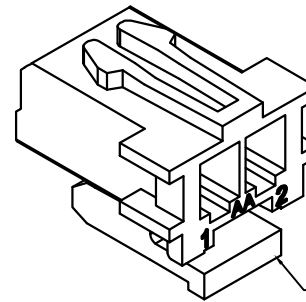

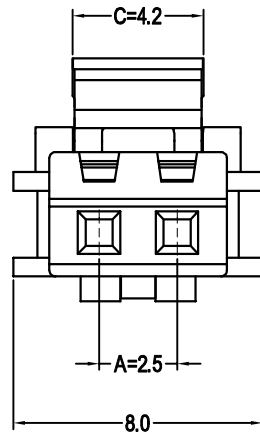

Plug Housing

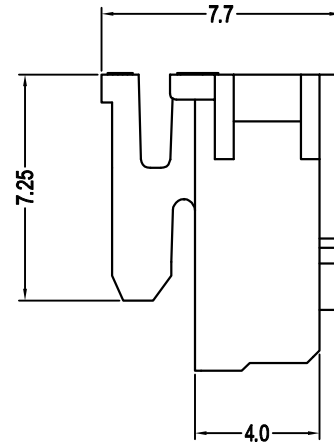
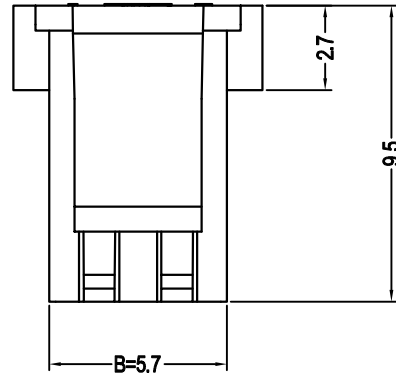

Opposite to the other pole.

Pole	Part No.	A	B	C
2	XHD-2Y	2.5	5.7	4.2

Item		 Yueqing Hegxing Electronics Co., Ltd				
Plug Housing		Unit	Scale	Design Unit	Size	Part No.
Model		mm	—	Metric	A4	 
XHD-2Y						
Draw	Review	Approve	Material	Drawing No.	Part No.	
			Material	PA66 (UL94V-0)		

Plug Housing

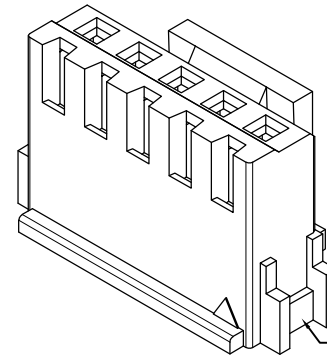
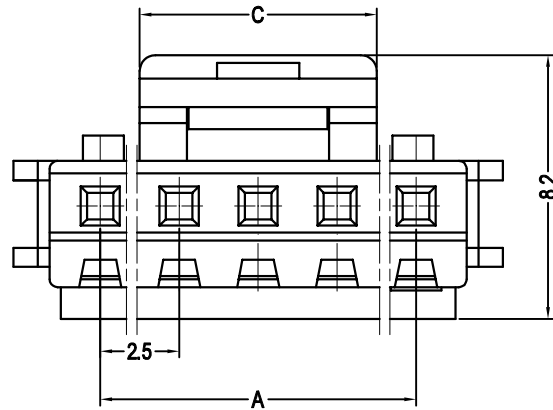
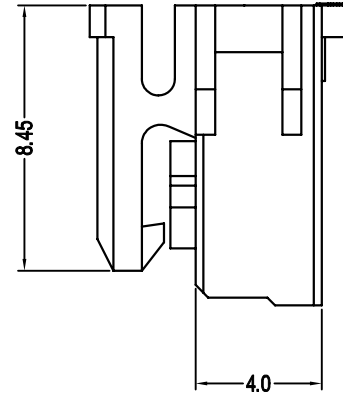
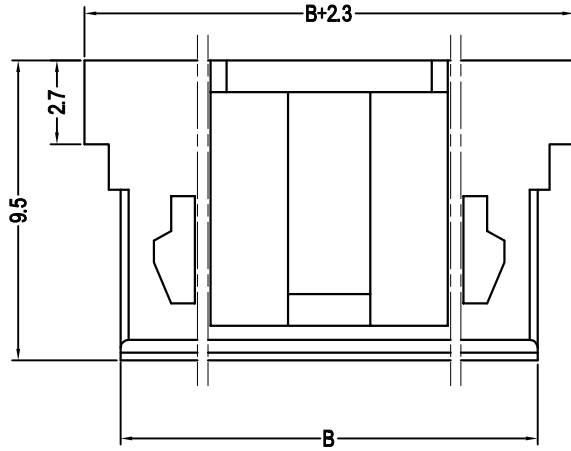

Different to YB, YC.

Pole	Part No.	A	B	C
3	XHD-3Y	5	8.2	3.6
4	XHD-4Y	7.5	10.7	6.1
5	XHD-5Y	10	13.2	7.5
6	XHD-6Y	12.5	15.7	7.5
7	XHD-7Y	15	18.2	7.5
8	XHD-8Y	17.5	20.7	7.5
9	XHD-9Y	20	23.2	7.5
10	XHD-10Y	22.5	25.7	7.5
11	XHD-11Y	25	28.2	7.5
12	XHD-12Y	27.5	30.7	7.5
13	XHD-13Y	30	33.2	7.5
14	XHD-14Y	32.5	35.7	7.5
15	XHD-15Y	35	38.2	7.5
16	XHD-16Y	37.5	40.7	7.5

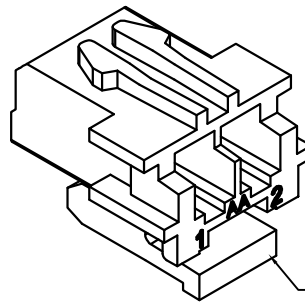
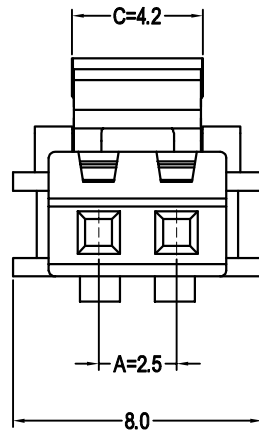
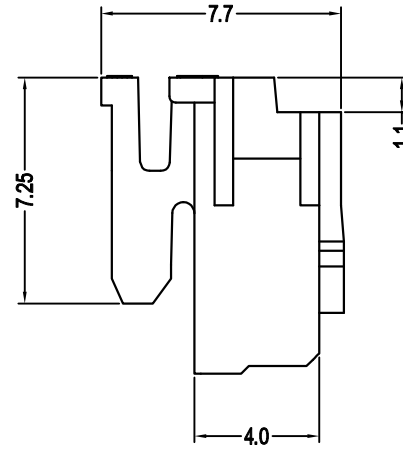
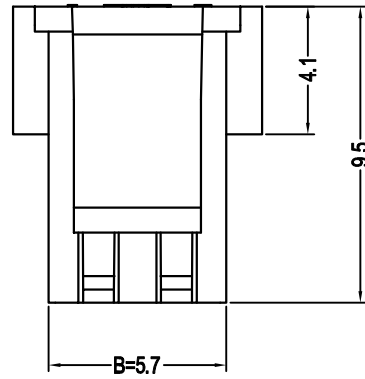

Item		Yueqing Hegxing Electronics Co., Ltd			
Plug Housing		HEGX			
Model	Unit	Scale	Design Unit	Size	Part No.
XHD-NY	mm	—	Metric	A4	
Draw	Review	Approve	Material	Drawing No.	Part No.
			Material	PA66 (UL94V-0)	

Plug Housing



Opposite to the others.

Pole	Part No.	A	B	C
2	XHD-2YB	2.5	5.7	4.2

Item		 Yueqing Hegxing Electronics Co., Ltd				
Plug Housing		Unit	Scale	Design Unit	Size	Part No.
Model		mm	—	Metric	A4	 
XHD-2YB						
Draw	Review	Approve	Material	Drawing No.	Part No.	
			Material	PA66 (UL94V-0)		

Plug Housing

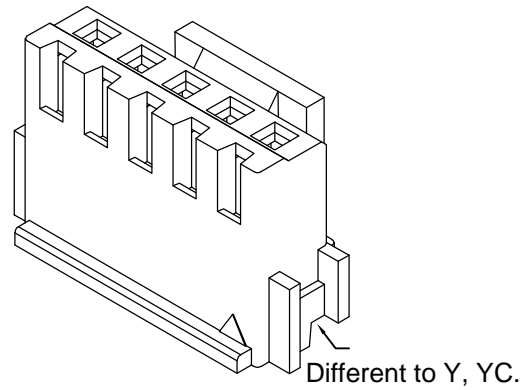
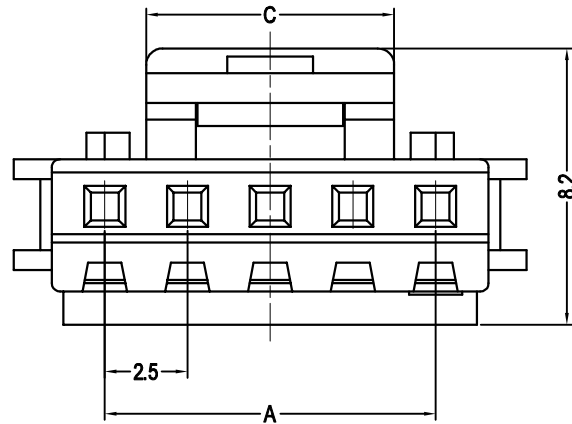
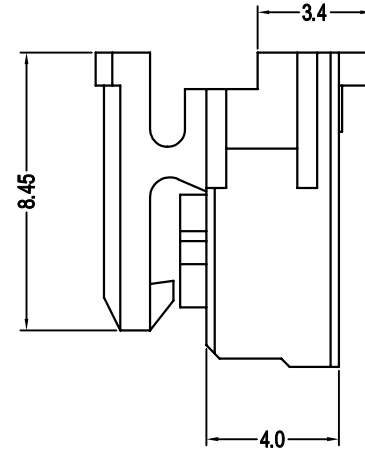
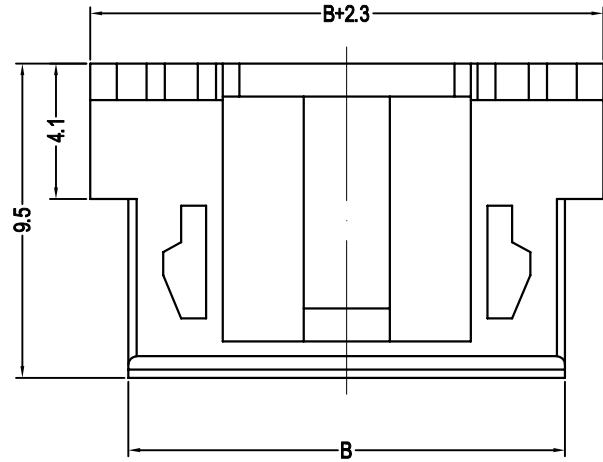

Pole	Part No.	A	B	C
3	XHD-3YB	5	8.2	3.6
4	XHD-4YB	7.5	10.7	6.1
5	XHD-5YB	10	13.2	7.5
6	XHD-6YB	12.5	15.7	7.5
7	XHD-7YB	15	18.2	7.5
8	XHD-8YB	17.5	20.7	7.5
9	XHD-9YB	20	23.2	7.5
10	XHD-10YB	22.5	25.7	7.5
11	XHD-11YB	25	28.2	7.5
12	XHD-12YB	27.5	30.7	7.5
13	XHD-13YB	30	33.2	7.5
14	XHD-14YB	32.5	35.7	7.5
15	XHD-15YB	35	38.2	7.5
16	XHD-16YB	37.5	40.7	7.5

Item		Yueqing Hegxing Electronics Co., Ltd			
Plug Housing		HEGX			
Model	Unit	Scale	Design Unit	Size	Part No.
XHD-NYB	mm	—	Metric	A4	
Draw	Review	Approve	Material	Drawing No.	Part No.
			Material	PA66 (UL94V-0)	

Plug Housing

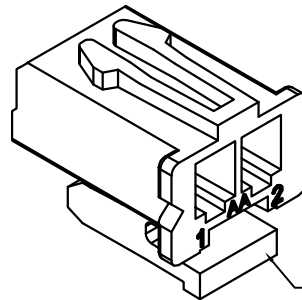
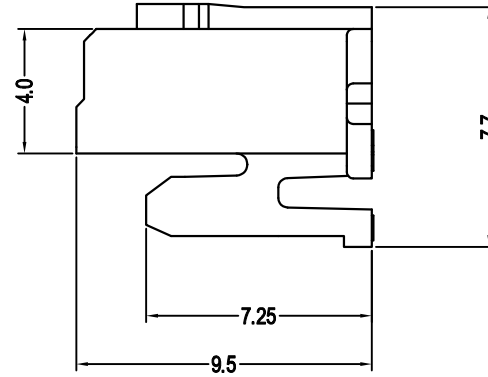
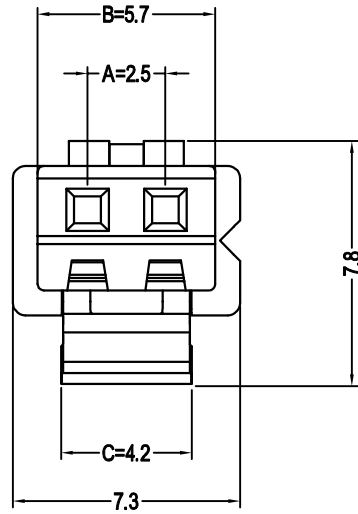

Opposite with the others.

Pole	Part No.	A	B	C
2	XHD-2YC	2.5	5.7	4.2

Item		 Yueqing Hegxing Electronics Co., Ltd				
Plug Housing		Unit	Scale	Design Unit	Size	Part No.
Model		mm	—	Metric	A4	
Draw	Review	Approve	Material	Drawing No.	Part No.	
			Material	PA66 (UL94V-0)		

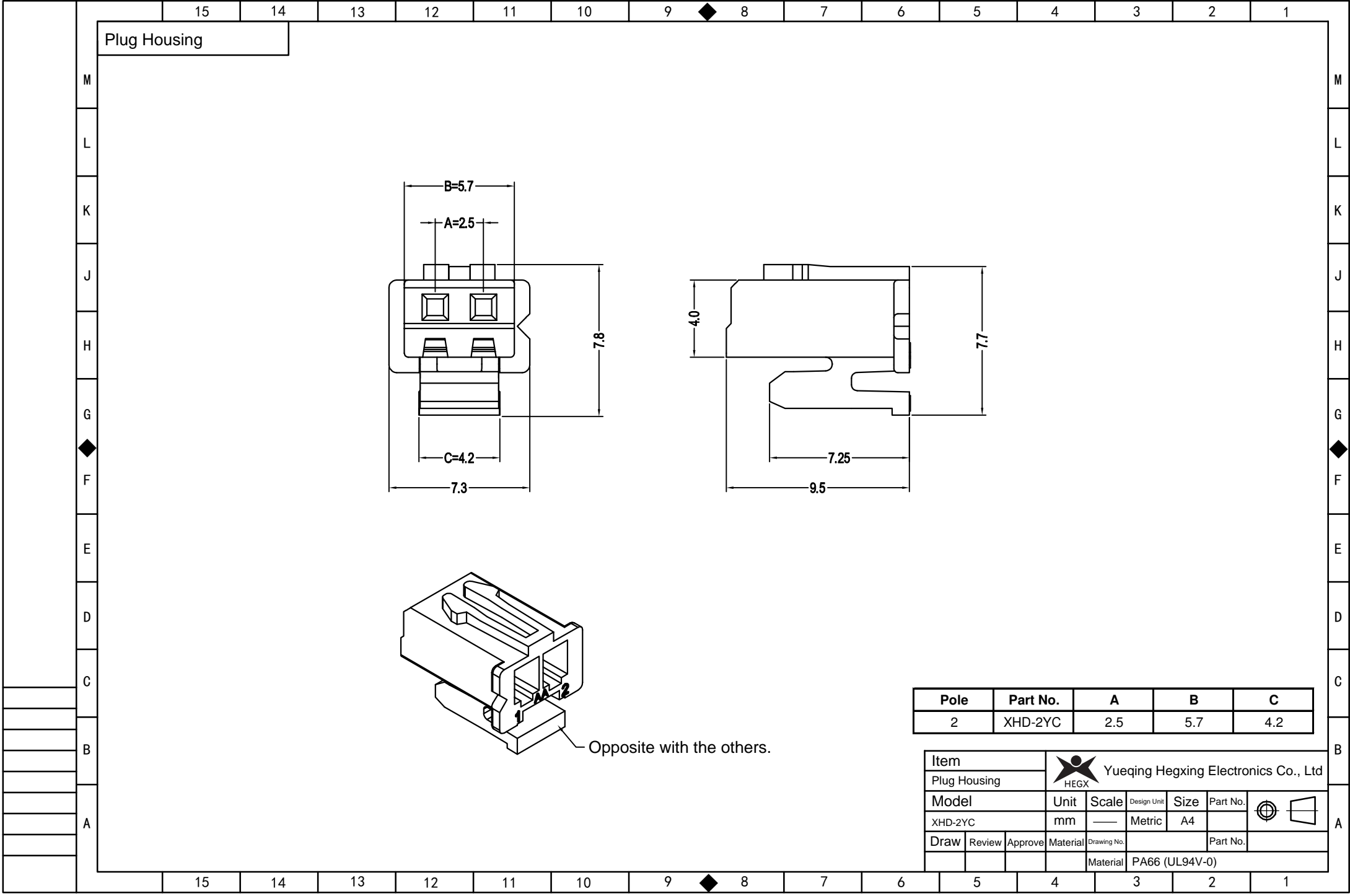

Plug Housing

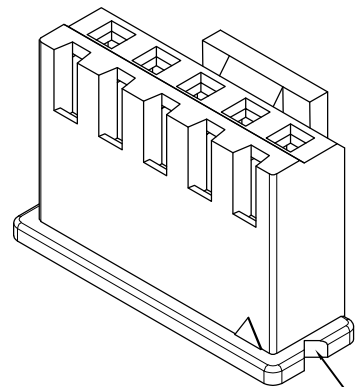
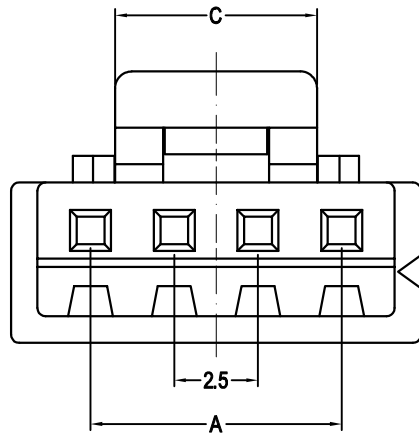
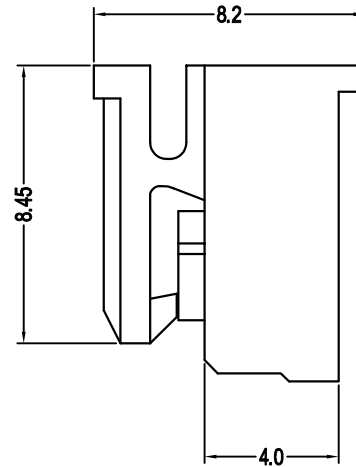
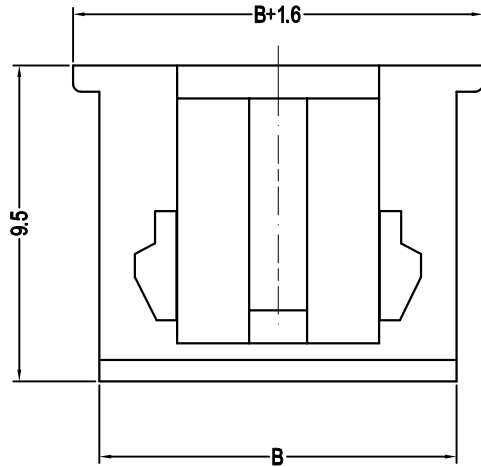

Pole	Part No.	A	B	C
3	XHD-3YC	5	8.2	3.6
4	XHD-4YC	7.5	10.7	6.1
5	XHD-5YC	10	13.2	7.5
6	XHD-6YC	12.5	15.7	7.5
7	XHD-7YC	15	18.2	7.5
8	XHD-8YC	17.5	20.7	7.5
9	XHD-9YC	20	23.2	7.5
10	XHD-10YC	22.5	25.7	7.5
11	XHD-11YC	25	28.2	7.5
12	XHD-12YC	27.5	30.7	7.5
13	XHD-13YC	30	33.2	7.5
14	XHD-14YC	32.5	35.7	7.5
15	XHD-15YC	35	38.2	7.5
16	XHD-16YC	37.5	40.7	7.5

Item		Yueqing Hegxing Electronics Co., Ltd			
Plug Housing		HEGX			
Model	Unit	Scale	Design Unit	Size	Part No.
XHD-NYC	mm	—	Metric	A4	
Draw	Review	Approve	Material	Drawing No.	Part No.
			Material	PA66 (UL94V-0)	

Plug Terminal

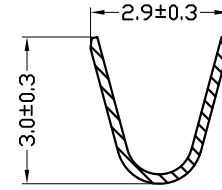
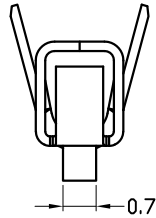
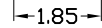
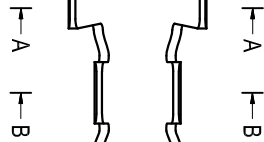
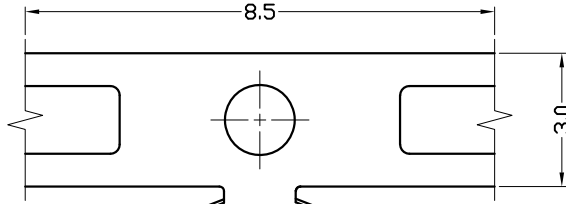
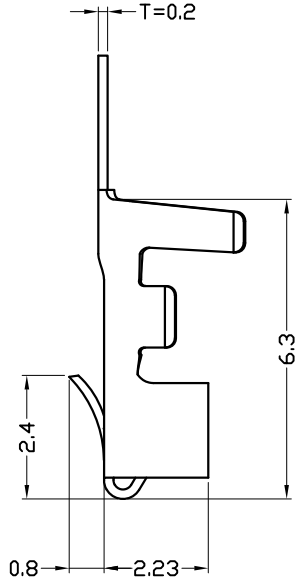

A-A

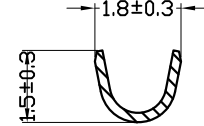

B-B

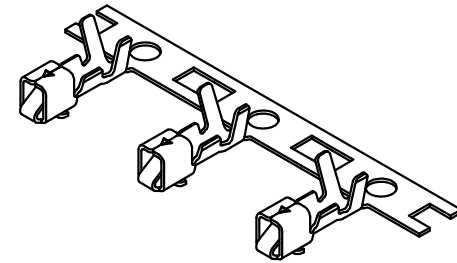

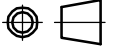

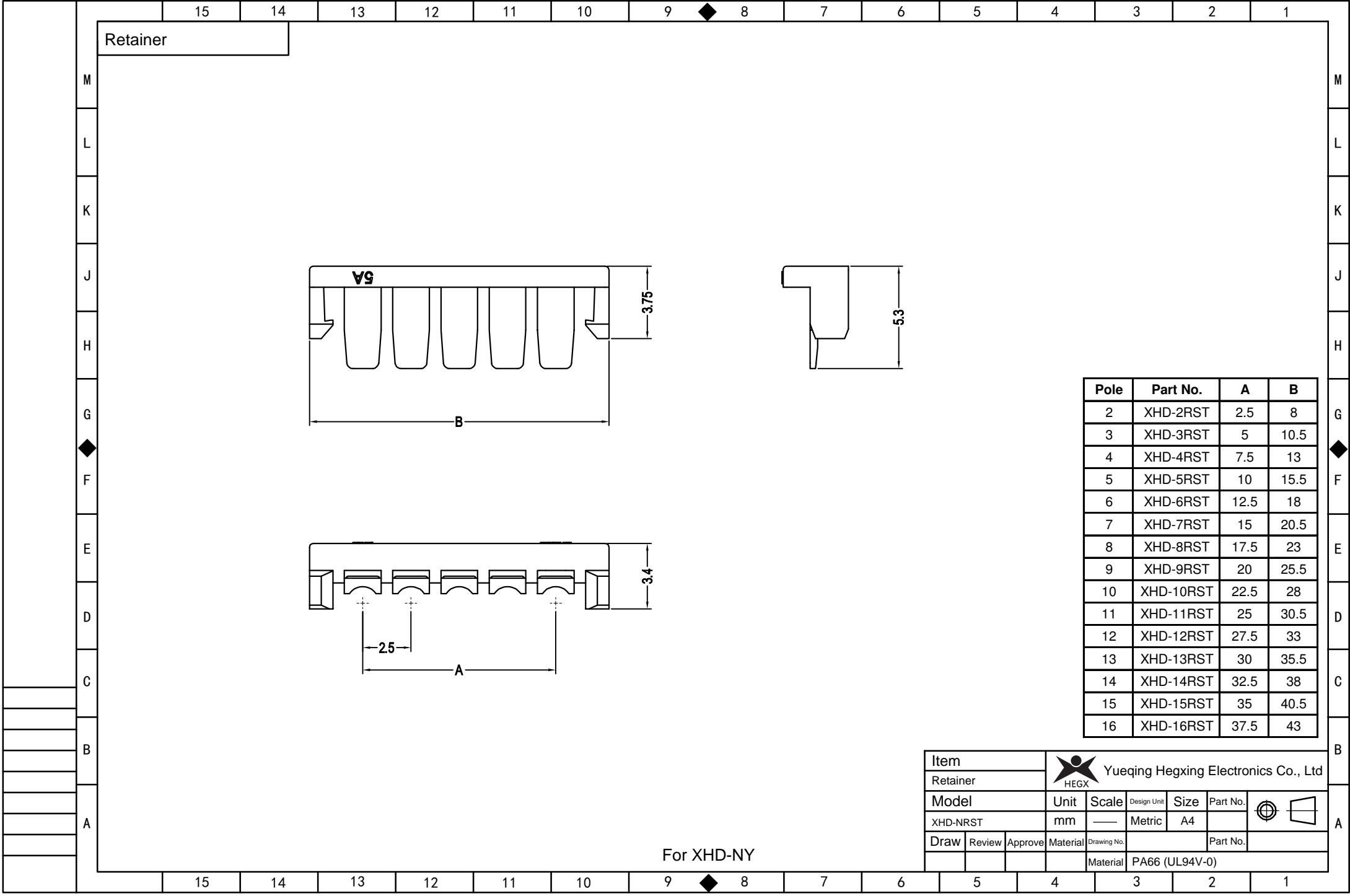
Item		 Yueqing Hegxing Electronics Co., Ltd					
Plug Terminal		Unit	Scale	Design Unit	Size	Part No.	
Model		mm	—	Metric	A4		
Draw	Review	Approve	Material	Drawing No.	Part No.		
			Material	Tinned Phosphor Bronze			



Pole	Part No.	A	B
2	XHD-2RST	2.5	8
3	XHD-3RST	5	10.5
4	XHD-4RST	7.5	13
5	XHD-5RST	10	15.5
6	XHD-6RST	12.5	18
7	XHD-7RST	15	20.5
8	XHD-8RST	17.5	23
9	XHD-9RST	20	25.5
10	XHD-10RST	22.5	28
11	XHD-11RST	25	30.5
12	XHD-12RST	27.5	33
13	XHD-13RST	30	35.5
14	XHD-14RST	32.5	38
15	XHD-15RST	35	40.5
16	XHD-16RST	37.5	43

For XHD-NY

Item		 Yueqing Hegxing Electronics Co., Ltd					
Retainer		Unit	Scale	Design Unit	Size	Part No.	 
XHD-NRST		mm	—	Metric	A4		
Draw	Review	Approve	Material	Drawing No.	Part No.		
			Material	PA66 (UL94V-0)			

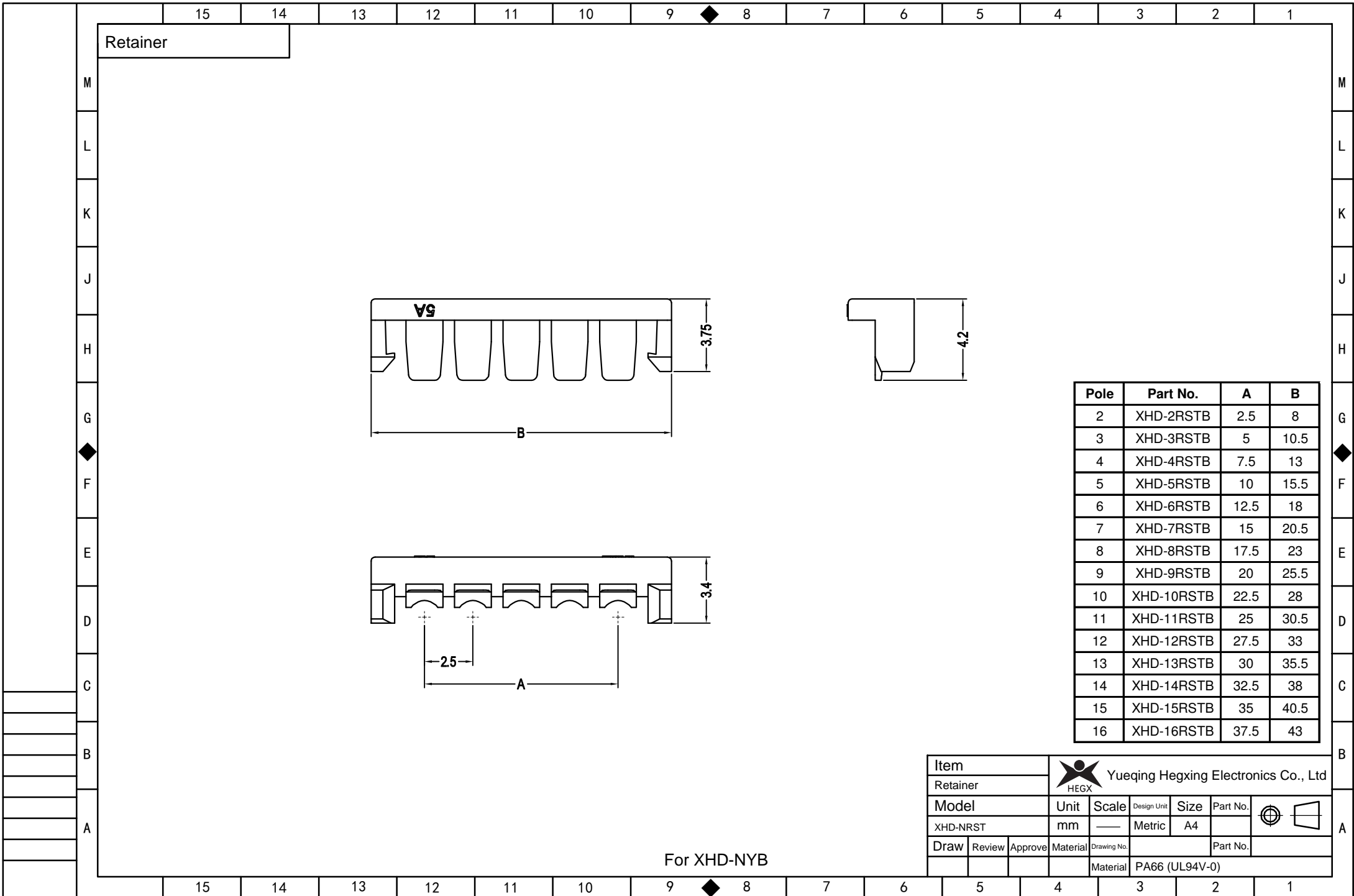

Retainer

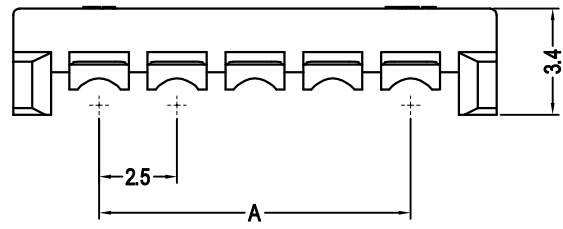
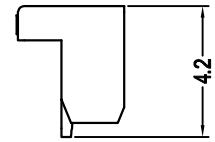
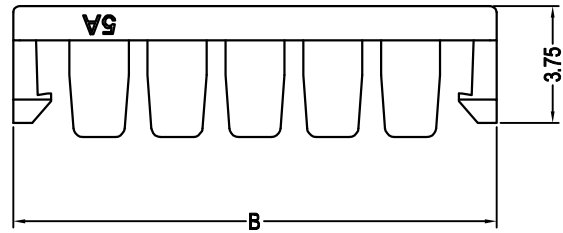

Pole	Part No.	A	B
2	XHD-2RSTB	2.5	8
3	XHD-3RSTB	5	10.5
4	XHD-4RSTB	7.5	13
5	XHD-5RSTB	10	15.5
6	XHD-6RSTB	12.5	18
7	XHD-7RSTB	15	20.5
8	XHD-8RSTB	17.5	23
9	XHD-9RSTB	20	25.5
10	XHD-10RSTB	22.5	28
11	XHD-11RSTB	25	30.5
12	XHD-12RSTB	27.5	33
13	XHD-13RSTB	30	35.5
14	XHD-14RSTB	32.5	38
15	XHD-15RSTB	35	40.5
16	XHD-16RSTB	37.5	43

Item		 Yueqing Hegxing Electronics Co., Ltd				
Retainer		Unit	Scale	Design Unit	Size	Part No.
XHD-NRST		mm	—	Metric	A4	
Draw	Review	Approve	Material	Drawing No.	Part No.	
				Material	PA66 (UL94V-0)	

For XHD-NYB

Wafer

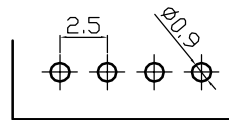
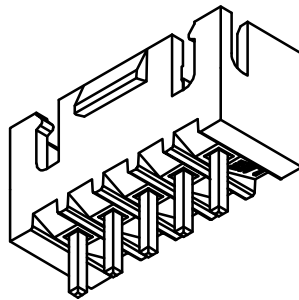
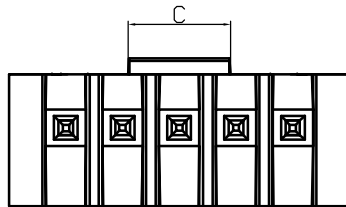
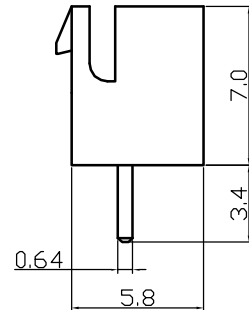
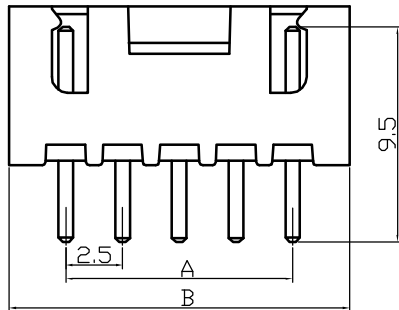



PCB Layout

Pole	Part No.	A	B	C
3	XHD-3A	5	10	3
4	XHD-4A	7.5	12.5	3
5	XHD-5A	10	15	4.5
6	XHD-6A	12.5	17.5	4.5
7	XHD-7A	15	20	4.5
8	XHD-8A	17.5	22.5	4.5
9	XHD-9A	20	25	4.5
10	XHD-10A	22.5	27.5	4.5
11	XHD-11A	25	30	4.5
12	XHD-12A	27.5	32.5	4.5
13	XHD-13A	30	35	4.5
14	XHD-14A	32.5	37.5	4.5
15	XHD-15A	35	40	4.5
16	XHD-16A	37.5	42.5	4.5

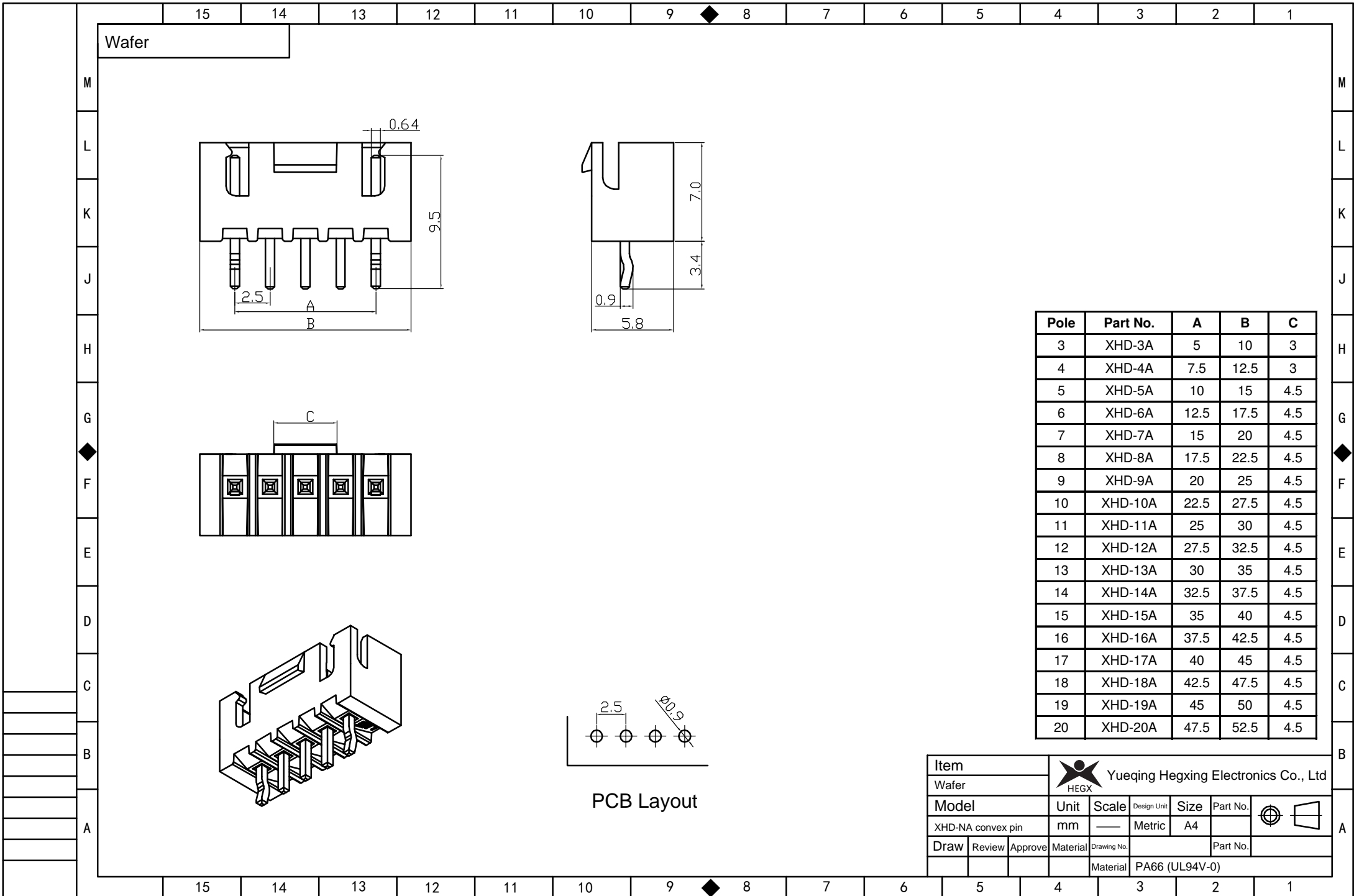
Item		 Yueqing Hegxing Electronics Co., Ltd				
Wafer		Unit	Scale	Design Unit	Size	Part No.
XHD-NA		mm	—	Metric	A4	
Draw	Review	Approve	Material	Drawing No.	Part No.	
			Material	PA66 (UL94V-0)		



Pole	Part No.	A	B	C
3	XHD-3A	5	10	3
4	XHD-4A	7.5	12.5	3
5	XHD-5A	10	15	4.5
6	XHD-6A	12.5	17.5	4.5
7	XHD-7A	15	20	4.5
8	XHD-8A	17.5	22.5	4.5
9	XHD-9A	20	25	4.5
10	XHD-10A	22.5	27.5	4.5
11	XHD-11A	25	30	4.5
12	XHD-12A	27.5	32.5	4.5
13	XHD-13A	30	35	4.5
14	XHD-14A	32.5	37.5	4.5
15	XHD-15A	35	40	4.5
16	XHD-16A	37.5	42.5	4.5
17	XHD-17A	40	45	4.5
18	XHD-18A	42.5	47.5	4.5
19	XHD-19A	45	50	4.5
20	XHD-20A	47.5	52.5	4.5

Item		 Yueqing Hegxing Electronics Co., Ltd				
Wafer						
Model	Unit	Scale	Design Unit	Size	Part No.	 
XHD-NA convex pin	mm	—	Metric	A4		
Draw	Review	Approve	Material	Drawing No.	Part No.	
			Material	PA66 (UL94V-0)		

PCB Layout

Wafer convex pin

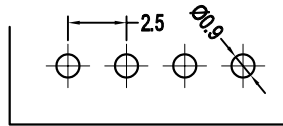
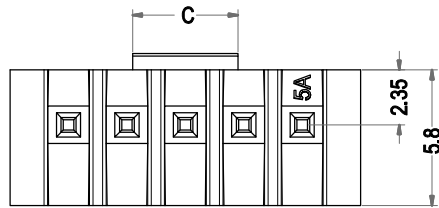
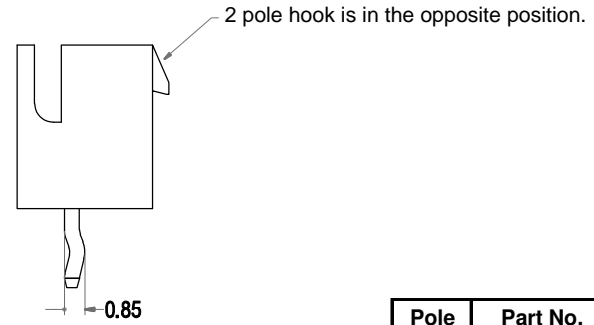
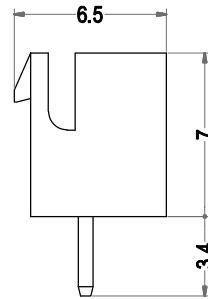
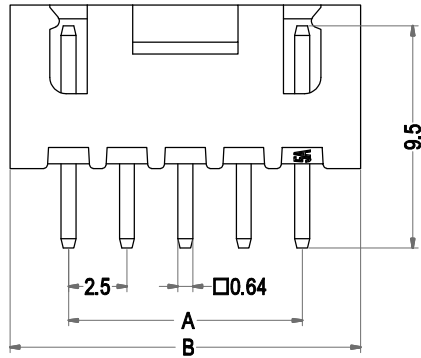

P. C. B LAYOUT

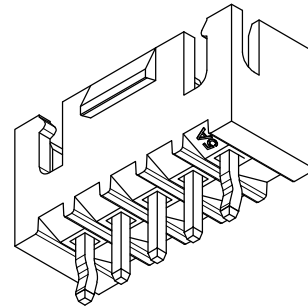

Pole	Part No.	A	B	C
3	XHD-3AD	5	10	3
4	XHD-4AD	7.5	12.5	3
5	XHD-5AD	10	15	4.5
6	XHD-6AD	12.5	17.5	4.5
7	XHD-7AD	15	20	4.5
8	XHD-8AD	17.5	22.5	4.5
9	XHD-9AD	20	25	4.5
10	XHD-10AD	22.5	27.5	4.5
11	XHD-11AD	25	30	4.5
12	XHD-12AD	27.5	32.5	4.5
13	XHD-13AD	30	35	4.5
14	XHD-14AD	32.5	37.5	4.5
15	XHD-15AD	35	40	4.5
16	XHD-16AD	37.5	42.5	4.5
17	XHD-17AD	40	45	4.5
18	XHD-18AD	42.5	47.5	4.5
19	XHD-19AD	45	50	4.5
20	XHD-20AD	47.5	52.5	4.5

Item		 Yueqing Hegxing Electronics Co., Ltd				
Wafer convex pin		Unit	Scale	Design Unit	Size	Part No.
Model		mm	—	Metric	A4	
Draw	Review	Approve	Material	Drawing No.	Part No.	
			Material	PA66 (UL94V-0)		

Wafer

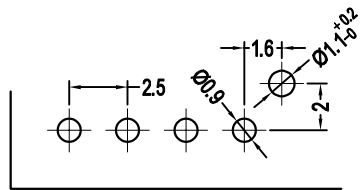
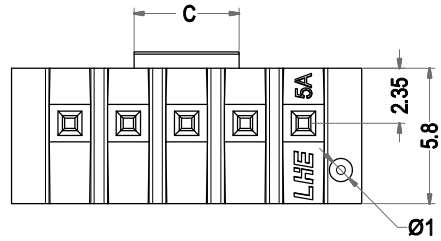
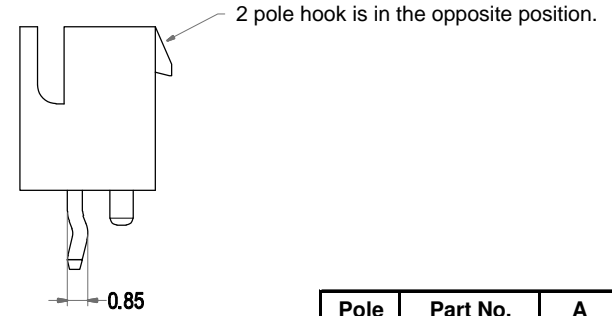
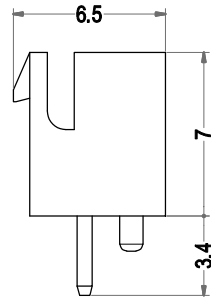
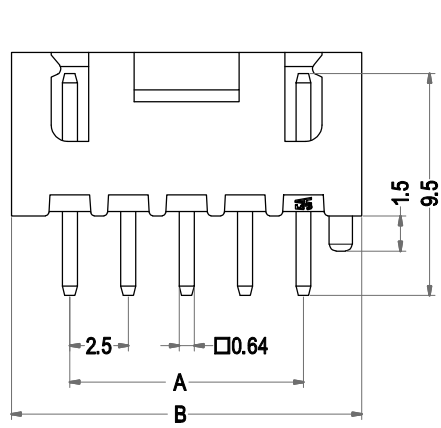

P. C. B LAYOUT

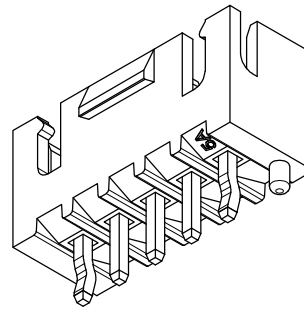

Pole	Part No.	A	B	C
3	XHD-3AW	5	10	3
4	XHD-4AW	7.5	12.5	3
5	XHD-5AW	10	15	4.5
6	XHD-6AW	12.5	17.5	4.5
7	XHD-7AW	15	20	4.5
8	XHD-8AW	17.5	22.5	4.5
9	XHD-9AW	20	25	4.5
10	XHD-10AW	22.5	27.5	4.5
11	XHD-11AW	25	30	4.5
12	XHD-12AW	27.5	32.5	4.5
13	XHD-13AW	30	35	4.5
14	XHD-14AW	32.5	37.5	4.5
15	XHD-15AW	35	40	4.5
16	XHD-16AW	37.5	42.5	4.5
17	XHD-17AW	40	45	4.5
18	XHD-18AW	42.5	47.5	4.5
19	XHD-19AW	45	50	4.5
20	XHD-20AW	47.5	52.5	4.5

Item		 Yueqing Hegxing Electronics Co., Ltd				
Wafer		Unit	Scale	Design Unit	Size	Part No.
XHD-NAW		mm	—	Metric	A4	
Draw	Review	Approve	Material	Drawing No.	Part No.	
				Material	PA66 (UL94V-0)	

Wafer convex pin

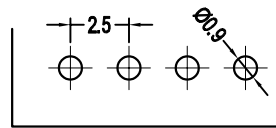
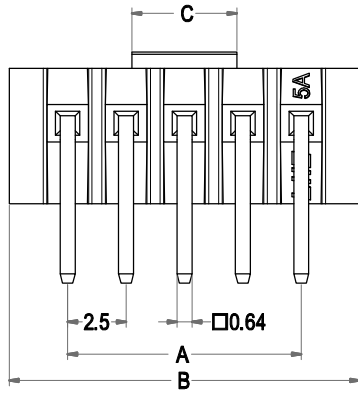
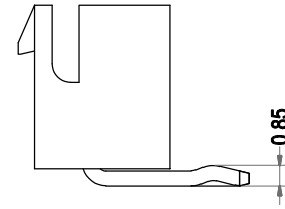
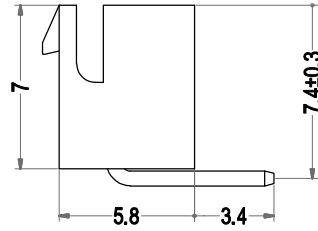
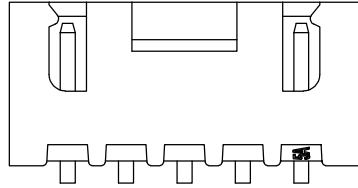

P. C. B LAYOUT

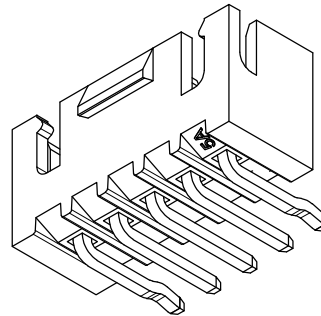

Pole	Part No.	A	B	C
3	XHD-3AWD	5	10	3
4	XHD-4AWD	7.5	12.5	3
5	XHD-5AWD	10	15	4.5
6	XHD-6AWD	12.5	17.5	4.5
7	XHD-7AWD	15	20	4.5
8	XHD-8AWD	17.5	22.5	4.5
9	XHD-9AWD	20	25	4.5
10	XHD-10AWD	22.5	27.5	4.5
11	XHD-11AWD	25	30	4.5
12	XHD-12AWD	27.5	32.5	4.5
13	XHD-13AWD	30	35	4.5
14	XHD-14AWD	32.5	37.5	4.5
15	XHD-15AWD	35	40	4.5
16	XHD-16AWD	37.5	42.5	4.5
17	XHD-17AWD	40	45	4.5
18	XHD-18AWD	42.5	47.5	4.5
19	XHD-19AWD	45	50	4.5
20	XHD-20AWD	47.5	52.5	4.5

Item		 Yueqing Hegxing Electronics Co., Ltd				
Wafer convex pin		Unit	Scale	Design Unit	Size	Part No.
XHD-NAD		mm	—	Metric	A4	
Draw	Review	Approve	Material	Drawing No.	Part No.	
			Material	PA66 (UL94V-0)		